



INTERNATIONAL MEASURERS' MANUAL

February 2013

PREFACE

This manual is designed to be a reference guide for existing International Measurers, with the aim of contributing to consistency in measurement / inspection all over the world. It should be also used as a learning tool for measurers who are gathering knowledge and experience with the aim of becoming International Measurers. Parts of this manual are used as textbook for ISAF International Measurer Seminars.

Since our sport is constantly changing and evolving, a manual such as this has to be a living document that needs to be updated constantly. Therefore, contributions to improve it are always welcome and will be posted on the ISAF Web site as updates are made. The responsibility for the contents of the International Measurers Manual and keeping it up to date lies with the International Measurers Sub Committee (IMSC) of the ISAF.

The origins of this manual can be traced back to the 1986 IYRU Measurement Manual, prepared by Tony Watts, former Chief Measurer of the IYRU. In 2004, Jean Pierre Marmier, IM (Soling & RC44), prepared a major update to that manual, which was finalized in May 2007 by the IMSC, and then published for the first time as the ISAF International Measurers Manual. The 2012 and 2013 versions cover all aspects of Class measurement / inspection, being enhanced and updated with new material, including relevant parts from the ISAF Guide to Sail Measurement, and the Race Officials Common Sections.

Through the years, the following persons have contributed in various ways, in building up this manual:

Simon Forbes, ISAF Technical Officer
Paul Handley, Former ISAF Technical Officer
Sebastian Edmonds, Former ISAF Technical Officer, IM (RS:X)

Antonio Cardona, IM (STAR, DRAGON)
Dimitris Dimou, IM (FINN, 420, 470)
Alex Finsterbusch, IM (420)
John Goldsmith, Former IM (TORNADO, A-CAT)
Peter Hinrichsen, IM (FD, FINN)
Barry Johnson, IM (420, 29er, 49er)
Ken Kershaw, IM (12M)
John Koopman, IM (STAR)
Paolo Luciani, IM (OPTIMIST, RC44)
Niki Nocke, IM (EUROPE)
Guy-Roland Perrin, IM (6M & 8M)
Edward T. Polidor, Former IM (SOLING)
Jüri Saraskin, IM (FINN)
David Sprague, IM (LIGHTNING)
Andrew Williams, IM (FARR 40)
Richard Hart, (Former member of EQSC)
Dina Kowalyshyn, (Former member of EQSC)
Cliff Norbury, Former Chairman of ISAF Sailing Committee
Nicola Sironi, ORC Chief Measurer
ERS Working Group 2001-2004 (Jim Hartvig Andersen, chairman)
In House Certification Working Group 2001-2004 (Bengt Gustafsson, chairman)

Special thanks to all of them.

Dimitris Dimou
Chairman
ISAF International Measurers Sub-Committee
February 2013

CONTENTS

Page

Preface

i

ISAF RACE OFFICIALS MANUAL COMMON SECTIONS

1	The Court of Arbitration for Sport (CAS)	
1.1	Introduction	1 / 2
1.2	Jurisdiction, Documents and Rules	1 / 2
1.3	CAS Hearings	1 / 2
1.4	ISAF Contact if involved in a CAS Hearing	1 / 3
2	Support Persons At Regattas	
2.1	Introduction	2 / 2
2.2	Definition of Support Persons, Coaches, Team leaders, Parents and Others	2 / 2
2.2.1	Relationship with Support Persons	2 / 3
2.2.2	Professional Coaches	2 / 3
2.2.3	Parents as Supporters	2 / 4
2.2.4	Other Support Persons	2 / 4
2.3	Regatta Services to Competitors	2 / 4
2.4	Initial and Daily Briefings for Competitors and Support Persons	2 / 5
2.4.1	Other Communications During the Regatta	2 / 6
2.5	Support Boats on the Water	2 / 7
2.6	Establishing Exclusion Zones on the Water	2 / 8
2.6.1	Safety Plans Involving Support Boats Afloat	2 / 9
2.6.2	Communication with Support Persons on the Water	2 / 10
2.7	Judges' Debriefing on Rule 42 Penalties	2 / 10
2.7.1	Umpires Communications to Competitors	2 / 10
2.8	When Things Go Wrong	2 / 11
2.8.1	Procedures to Investigate and Penalise under the Rules	2 / 11
2.8.2	Incidents Involving Parents and Other Support Persons	2 / 12
2.9	Allegations of Physical or Sexual Abuse of a Youth by a Coach, Parent or Support Person	2 / 12
2.10	Examples of Incidents that have Occurred at Regattas	2 / 13
3	Crisis Management	
3.1	Objectives	3 / 2
3.2	Introduction	3 / 2
3.3	Risk Assessment and Crisis Management Plan	3 / 2
3.4	Influence of Event Types on Safety Provision	3 / 3
3.5	Responsibilities	3 / 3
3.5.1	Competitors	3 / 3
3.5.2	Race Officer	3 / 3
3.6	Outline Structure of Safety Plan	3 / 4
3.6.1	Dinghy and Board Events	3 / 4
3.6.2	Ocean, Offshore and Yacht Racing Events	3 / 8
4	Race Officials and Junior Sailors	
4.1	Introduction	4 / 2
4.2	Definition of Junior Sailors	4 / 2
4.3	Race Officials Role at Junior Regattas	4 / 3
4.4	Visibility	4 / 3
4.5	Communication With Sailors and Their Coaches	4 / 4

4.6	Protests	4 /4
4.7	Observers	4 /4
4.8	Use of the Protest Flag	4 /5
4.9	Reporting to the Race Committee At The Finish	4 /5
4.10	Arbitration	4 /5
4.11	Rule 42 and Appendix P	4 /5
4.12	Regatta Briefings	4 /6
4.13	Parents, Coaches and Club Support	4 /7
4.14	Support Boats	4 /7
4.15	Rule 69 Gross Misconduct	4 /7
4.16	Sailor's Ethics	4 /8
4.17	Legal Obligations of Child Protection	4 /8
4.18	Outside Assistance	4 /9
4.19	ISAF Introductory Rules of Racing	4 /9
4.20	Sailing Instructions	4 /9
5	Handling Misconduct	
5.1	Introduction	5 /2
5.2	When should rule 69 be used	5 /2
5.3	Who is subject to rule 69.1	5 /2
5.4	Types of behaviour justifying a rule 69 hearing	5 /3
5.5	Who may make a report	5 /3
5.6	Form of Report	5 /3
5.7	Who should the report be lodged to	5 /3
5.8	Reports lodged with organizing authorities/clubs/other authorities	5 /4
	Appendix A: Examples of Gross Misconduct	5 /5
6	Guidelines for Dealing with the Media	
6.1	Introduction	6 /2
6.2	Definition	6 /2
6.3	ISAF's Approach to the Media	6 /2
6.4	What to do and what not to do when talking to the media	6 /2
6.4.1	Do	6 /3
6.4.2	Don't	6 /4
6.4.3	Understanding how Journalists Work	6 /4
6.4.4	Keeping a record of press contacts	6 /5

ISAF Int. Measurers' Manual

A The Basics

A.1	Introduction	A 2
A.2	Meaning of Terms	A 2

B ISAF International Measurer Programme

B1	International Measurer (IM)	B 2
B.2	Terms of Appointment	B 4
B.3	Applications for Appointment and Re-appointment	B 4
B.4	General Qualifications required of all International Race Officials and Additional Qualifications for an International Measurer	B 5
B.5	Considerations for Appointment	B 6

C	Qualities of an International Measurer	
C.1	Personal Attributes / Abilities	C 2
C.2	Code of Behaviour	C 2
C.3	Conflict of Interest	C 3
D	Reserved for future use	
E	Measurement Fundamentals	
E.1	“Measurer”	E 2
E.1.1	Role of the “Measurer”	E 2
E.1.2	Qualifications of “Measurers”	E 3
E.1.3	Appointment and Authority of “Measurers”	E 3
E.1.4	“Measurer’s” Practice	E 5
E.2	Application of Class Rules	E 6
E.2.1	Objectives of Class Rules	E 6
E.2.2	Changes to Class Rules	E 7
E.2.3	Interpreting Class Rules	E 8
E.2.4	Plans – Drawings	E 8
E.2.5	Construction Rules	E 8
E.3	Certification Measurement	E 9
E.3.1	Measurer	E 9
E.3.2	Arrangement for Measurement	E 9
E.3.3	Measurement Conditions	E 9
E.3.4	Measurement Forms and Certificates	E 10
E.3.5	Recording Measurements	E 10
E.3.6	Declaration	E 11
E.3.7	International Class Fees and ISAF Plaques	E 11
E.3.8	Application for a Measurement Certificate	E 11
E.4	Measurement of Alterations	E 11
E.4.1	Replacements	E 12
E.4.2	Performance Alterations	E 12
E.4.3	Repairs	E 12
E.5	Racing Rules and Measurement	E 12
E.5.1	Measurer’s responsibility – RRS 78.3	E 12
E.5.2	Damage or deviations in excess of tolerances, measurement protests RRS 64.3	E 13
E.5.3	Identification on Sails RRS 77	E 14
E.5.4	Advertising: RRS 80 and ISAF Regulation 20	E 14
E.5.5	Right to Protest RRS 60.2	E 14
F	Accuracy, Precision and Reproducibility in Measurement	
F.1	Introduction	F 2
F.2	Basic Standards and Units	F 2
F.3	Definition of terms	F 3
F.4	Errors	F 5
F.5	Measurement Techniques and Reproducibility	F 15
F.6	Tool certification: Accuracy & Standards	F 16
F.6.1	Mechanical tools for length measurements	F 17
F.6.2	Electronic tools for length measurements	F 17
F.6.3	Straight Edges	F 18
F.6.4	Square Edges	F 18
F.6.5	Spirit and Electronic Levels	F 18
F.7	Mass and Weight	F 19
F.7.1	Scales	F 23

G	Measurement Tools	
G.1	Standard Measurement Tools	G 2
G.2	Purpose-designed measurement tools	G 5
G.3	Specialized tools	G 7
G.4	Special Equipment	G 8
G.5	Class-Specific Equipment	G 10
H	Hull Measurement	
H.1	Hull Shape Measurement	H 3
H.1.1	Introduction	H 3
H.1.2	Reference Systems	H 3
H.1.3	Hull Length and Width	H 5
H.1.4	Hull Profile	H 7
H.1.4.1	Simplified Keel Rocker measurement	H 11
H.1.5	Hull Sections	H 14
H.1.5.1	Section measurement using templates	H 14
H.1.5.2	Section Measurement for hulls with chines	H 18
H.1.5.3	Section measurement for development classes	H 19
H.1.5.4	Hull measurement with a model template	H 19
H.1.5.5	Generic Hull measurement: XYZ coordinates	H 20
H.1.6	Stem profile	H 21
H.1.6.1	Stem Templates	H 21
H.1.6.2	Rake of Stem	H 21
H.1.7	Transoms	H 22
H.1.8	Measurements in way of centreboard slot	H 22
H.1.9	Radius of chines	H 22
H.1.10	Deck camber	H 22
H.1.11	Sheer guards or rubbing strakes	H 22
H.1.12	Internal measurements	H 23
H.1.13	Fairness of the surface of the hull	H 23
H.2	Hull measurement with templates: Case studies	H 23
H.2.1	Toolkit	H 23
H.2.2	Baselines	H 24
H.2.3	Hull setup	H 26
H.2.4	Keel profile measurement	H 29
H.2.5	Template Measurement	H 31
H.2.6	Deck Measurement	H 32
H.2.7	FD Class hull measurement system	H 33
H.2.8	Tornado Class hull measurement system	H 36
H.2.9	Hull measurement of a “chine” hull: Case study for the Lightning Class.	H 38
H.2.9.1	Hull setup	H 38
H.2.9.2	Levelling and measurement of hull	H 39
H.3	Hull Weight	H 46
H.3.1	Hull weighing conditions	H 46
H.3.2	Underweight boats and weight correctors	H 47
H.3.3	Weighing at Major Events	H 47
H.4	Weight Distribution	H 49
H.4.1	The “Lamboley” Swing Test	H 50
H.4.2	Weight Distribution and Centre of Gravity: Practice	H 53
H.4.2.1	Errors and their reduction	H 56
H.4.3	Snipe Class swing test & Lightning bounce test	H 58

H.4.4	Dragon Class swing test	H 60
H.4.5	Star Class swing test	H 63
H.4.6	Stewart 34 Class swing test	H 63
H.4.7	Yngling Class tilt swing test	H 64
H.4.8	Bifilar suspension test	H 66
H.4.9	The complete boat	H 68
H.5	Buoyancy	H 70
H.5.1	Buoyancy apparatus	H 70
H.5.2	Immersion buoyancy tests	H 71
H.5.3	Buoyancy tank air test	H 71
H.5.4	Buoyancy inspection	H 72
H.6	Measurement with Ultrasonic Thickness Gages	H 72
H.6.1	Introduction	H 72
H.6.2	Considerations	H 72
H.6.3	Getting Started	H 74
H.6.4	Technique	H 75
H.6.5	Data	H 76
H.7	Laser Measurement Methods	H 76
H.7.1	Laser Tracker	H 76
H.7.2	Total Station	H 80
I	Hull Appendages	
I.1	Profile	I 2
I.2	Section	I 3
I.3	Position	I 5
I.4	Other controls	I 7
I.5	Hull Appendage inspection at events	I 8
J	Rigs	
J.1	Introduction	J 2
J.2	Spar measurement points and limit marks	J 2
J.3	Section measurements of spars	J 4
J.4	Curvature (Straightness) of spar	J 4
J.5	Weight	J 4
J.5.1	Mast centre of gravity measurement	J 5
J.5.2	Mast tip weight measurement	J 6
J.6	Deflection tests	J 8
J.7	Rigging points	J 9
J.8	Poles	J 9
J.9	ERS Rig measurement in steps	J 9
J.10	Rig Inspection at events	J 13
K	Sails	
K.1	Sail Construction	K 2
K.1.1	Types of ply	K 2
K.1.2	Ply weight / thickness	K 3
K.1.3	Sail materials	K 8
K.1.4	Fibres found in Sail materials	K 11
K.1.5	Methods of Sail manufacture	K 16
K.1.6	Glossary (of Sail Material Terms)	K 18
K.2	Sail dimensions measurement	K 19
K.2.1	Corner measurement points (ERS G.4)	K 19
K.2.2	Sail edge measurement points (ERS G.5)	K 21

K.2.3	Primary sail dimensions (ERS G.7)	K 23
K.2.4	Other Sail Dimensions (ERS G.8)	K 26
K.2.5	Additional Sail Controls	K 29
K.2.6	Identification on Sails	K 29
K.2.7	Advertising on Sails	K 31
K.2.8	Certification marks on Sails	K 32
K.2.9	Non-standard sail measurement examples	K 33
K.3	Inspection of Sails	K 38
K.3.1	Sail Table Preparation	K 38
K.3.2	Sail Table Application	K 43
K.4	Sail Area Measurement	K 44
K.4.1	General	K 44
K.4.2	Sail Area measurement instructions	K 44
K.4.2.1	Preliminary remarks	K 45
K.4.2.2	Spars and Wing Sails	K 45
K.4.2.3	Soft sails set on Spars	K 46
K.4.2.4	Soft sails not set on Spars	K 48
K.4.2.5	Sails of unusual shape	K 49
K.4.2.6	Spinnakers	K 49
K.4.3	Recording Measurements and Calculations	K 49
K.4.4	Test Case: Moth Sail Measurement	K 49
L	Equipment Inspection	
L.1	Introduction	L 2
L.2	Fundamental issues	L 2
L.2.1	Single Class versus Multi-Class events	L 2
L.2.2	Inspection Levels	L 3
L.2.3	Facilities and resources	L 4
L.3	General Guidelines	L 5
L.4	Equipment Inspector's Responsibilities	L 6
L.5	Measurement team Management	L 9
L.6	Inspection methods and tools	L 9
L.7	Special Inspection issues	L 10
L.7.1	Personal / Portable Equipment	L 10
L.7.2	Crew weight	L 11
L.7.2.1	Class Rules Approaches	L 12
L.7.2.2	Event Inspection of Crew Weight	L 14
L.7.3	Wet clothing	L 17
L.8	Equipment Inspection Procedure Examples	L 18
L.8.1	Measurement Preparation & Outline of Stations: OPTIMIST Class	L 18
L.8.2	Measurement Regulations: 470 Class	L 23
L.8.3	Laser Class Inspection Guidelines	L 26
M	Measurement Protests	
M.1	Introduction	M 2
M.2	Right to Protest	M 2
M.3	Relevant Rules and other Documents	M 2
M.3.1	RR 78	M 2
M.3.2	RR 64.3	M 3
M.3.3	RR 43	M 5
M.3.4	RR 69 Gross Misconduct	M 5
M.3.5	Class Rules and ERS	M 5
M.3.6	Notice of Race and Sailing Instructions	M 6

M.4	Other issues	M 6
M.4.1	Acceptance of a Measurement Protest	M 6
M.4.2	Protest Committee's Responsibility	M 7
M.4.3	Expert Witnesses and Evidence	M 7
M.4.4	Damaged Equipment	M 7
M.4.5	Re-measurement	M 7
M.4.6	Appeals	M 8

N - Y Reserved for future use

Z Glossary, Conversion Factors and Material Data

Z.1	Glossary and Abbreviations	Z 2
Z.2	Conversion Factors	Z 13
Z.3	Mass Density of Some Substances	Z 14



ISAF RACE OFFICIALS MANUALS

COMMON SECTIONS



ISAF RACE OFFICIALS MANUALS

COMMON SECTIONS

SECTION 1

The Court of Arbitration for Sport (CAS)

Contents		Page
1.1	Introduction	1 / 2
1.2	Jurisdiction, Documents and Rules	1 / 2
1.3	CAS Hearings	1 / 2
1.4	ISAF Contact if involved in a CAS Hearing	1 / 3

1.1. Introduction

The Court of Arbitration for Sport (CAS) is an international arbitration body set up to settle disputes related to sport.

In recent years there have been several sailing related matters that have been determined by CAS.

It is important to recognise that there are limited matters where CAS will have jurisdiction.

In order for a dispute to be submitted to CAS, there must be an arbitration agreement between the parties which specifies recourse to CAS. ISAF have invoked the jurisdiction of CAS in limited circumstances and reference is made to those in the ISAF Regulations, e.g., anti-doping.

Parties may by agreement refer a matter to CAS for resolution as it is an arbitration body.

1.2. Jurisdiction, Documents and Rules

Jurisdiction is also conferred in respect of any dispute arising on the occasion of, or in connection with, the Olympic Games by virtue of Article 59 of the Olympic Charter and this provides that such disputes must be submitted exclusively to CAS.

It should be noted that this does not refer just to the occasion of the Olympic Games but to any dispute arising “in connection with” the Olympic Games.

CAS has rules regarding lodgement of documents and it is common for lawyers to appear for parties in such matters.

CAS panels are made up of lawyers and judges who are experienced in dealing with sport matters but may not necessarily be familiar with sailing. Accordingly, it is important to ensure that a full explanation of matters is put into the documentation to be lodged with CAS explaining the position of the party prior to the hearing. This will include the ISAF Rule Book and quite likely the Notice of Race and Sailing Instructions and an explanation of the circumstances giving rise to the decision being appealed.

It is important to recognise that CAS has jurisdiction to overrule the Rules of sports federations and their protest committees if they find that decision making bodies have conducted themselves with a lack of good faith or not in accordance with due process. Appeals will usually be lodged with CAS in relation to:

- Field of Play matters;
- Matters relating to a protest hearing.

1.3. CAS Hearings

In relation to hearings CAS’s focus will usually be on procedural fairness and to ensure that the Protest Panel has applied their Rules and not acted with bias or otherwise in bad faith.

As a general principle, CAS will not interfere with decisions made on the “field of play”. The reason for this is that such a body will not generally review decisions of judges and umpires who are well-placed to decide such matters on the field of play and such matters are usually of a technical/specialised nature.

This approach however is always tempered by the requirement that such decisions must not be taken in violation of the rules of the sport and law or such decisions made in bad faith, e.g., as a consequence of corruption, nationality bias or something similar. In summary, CAS does not have the function of reviewing technical matters and CAS will only interfere if an official's field of play decision is tainted by fraud or arbitrariness or corruption.

Some instructions commonly include penalties which can be less than disqualification. Experience has shown that it is important for a Jury to have in place, prior to the event, a document that gives guidance to the Jury as to the criteria to be applied in determining an appropriate penalty in such case. Such documentation and a demonstration as to how the Jury applied such criteria would be very useful in such a case.

Experience has shown that CAS is supportive of decisions made by Race Officials provided the above is followed.

1.4. ISAF Contact If Involved In A CAS Hearing

As CAS matters can be complicated, Race Officials involved in a CAS Appeal should immediately advise the ISAF Secretary General. It is also quite possible that ISAF will be a party to any such proceedings.



ISAF RACE OFFICIALS MANUAL

COMMON SECTION 2

Support Persons at Regattas

Contents	Page
2.1 Introduction	2 /2
2.2 Definition of Support Persons, Coaches, Team leaders, Parents and Others	2 /2
2.2.1 Relationship with Support Persons	2 /3
2.2.2 Professional Coaches	2 /3
2.2.3 Parents as Supporters	2 /4
2.2.4 Other Support Persons	2 /4
2.3 Regatta Services to Competitors	2 /4
2.4 Initial and Daily Briefings for Competitors and Support Persons	2 /5
2.4.1 Other Communications During the Regatta	2 /6
2.5 Support Boats on the Water	2 /7
2.6 Establishing Exclusion Zones on the Water	2 /8
2.6.1 Safety Plans Involving Support Boats Afloat	2 /9
2.6.2 Communication with Support Persons on the Water	2 /10
2.7 Judges' Debriefing on Rule 42 Penalties	2 /10
2.7.1 Umpires Communications to Competitors	2 /10
2.8 When Things Go Wrong	2 /11
2.8.1 Procedures to Investigate and Penalise under the <i>Rules</i>	2 /11
2.8.2 Incidents Involving Parents and Other Support Persons	2 /12
2.9 Allegations of Physical or Sexual Abuse of a Youth by a Coach, Parent or Support Person	2 /12
2.10 Examples of Incidents that have Occurred at Regattas	2 /13

2.1 Introduction

This Section addresses interaction with coaches, parents and other support personnel at regattas and how to handle problems that may arise. Interactions involve arrangements, communications, and access to the proceedings of the regatta, e.g. briefings and protest hearings. Interaction also includes working through a problem when something goes wrong.

2.2 Definition of support persons: Coaches, Team Leaders, Parents and Others

Competitors often come to regattas with Coaches, Team Leaders, Parents or other persons who support them. They provide physical or advisory support to a competitor, including the gathering of data that may be used at a later time. In this section we use the term, “support persons” to include all such individuals.

Support persons are an important part of regattas, taking an active role in getting the competitors to and from, and supporting them throughout the regatta. This will vary, depending on the type of event and the age of the competitors. They will accompany the competitors to events, seeking admission to the venue and, where allowed, accreditation to enter restricted areas, requesting the use of launch facilities and mooring spaces for their powerboats and participate in the social activities. The role they play with their competitors is important to the competitors’ success and will normally involve interaction with officials on behalf of their competitors but it is preferable that their discussions/submissions should be with the competitor(s) they are registered with.

Depending on the standard of the competitors, e.g. national teams, competitors may also have support personnel, such as weather experts, rules experts, and others who do not travel to the venue. Where it has been set up prior to the regatta it is helpful to these persons to have information, such as notices posted on the Official Notice Board, protests listed for hearing and decisions, and other information published simultaneously on the event web site. It is not always possible to have simultaneous web postings and this is dependent on the sophistication of the event web site and the funds available to have such a web site. Currently there is no *standard* style of web site to provide this. These web postings make information directly available to off-site support personnel for their benefit and associated competitors.

It is useful for race officials to know who the support personnel at regattas are, which competitors they are associated with and the role they are playing. It is also important for race officials to understand the relationships between competitors and their support personnel.

At some regattas, competitors or teams are selected and entered by their Member National authority or sailing club. These MNAs or clubs often appoint their own Coaches or Team Leaders. At youth and junior regattas, parents, or other adults often accompany competitors and frequently take responsibility for the wider well-being of the competitors. At other regattas competitors often bring their own Coach or other support personnel. Sometimes these people are shared by several competitors.

2.2.1 Relationship with Support Persons

Support persons often approach officials on behalf of their competitors, or along with competitors, to get information about the schedule and running of the regatta, or to enquire about any penalties or actions taken against their competitors.

It is beneficial to have a working relationship with support persons, just as it is with competitors. An appropriate relationship is where the support persons feel included and respected, and they have respect for the race officials to carry out their role without interference.

The best way to go about establishing an appropriate relationship will depend upon many factors and will vary from regatta to regatta. The variables will include the particular environment, the personality of the race official concerned, and the attitude and level of experience of the support persons to name a few. The more often a race official officiates at that class the stronger the respect becomes between the officials and support people.

Some of the techniques that have served race officials well include:

- Be visible and approachable.
- Be seen around the regatta site and on the water. Be available to talk with support persons, while avoiding the appearance of taking a personal interest in one individual or group. However, where possible, ensure there are two officials walking around the site or at any discussion.
- Being approachable does not mean that you should try to please everybody all the time as, to do so, will only create a situation where you please nobody or, worse still, appear weak and able to be manipulated.
- Be aware of cultural and language differences. What might be considered normal and acceptable behaviour in one culture could be confronting or rude in another. Learning a few words in a foreign language such as “good morning” can go towards establishing a good relationship even if communication is otherwise difficult.

2.2.2 Professional Coaches

Many Coaches are paid professionals. Some have performance contracts, with provisions that their future livelihood depends on the success of the competitors they are coaching. Often coaches and team leaders have as much or more regatta experience than the race officials and can have a unique understanding of any current issues that might arise. Being mindful of these possible circumstances when their competitors are not performing well can be useful background to officials when interacting with Coaches and competitors over specific issues.

Coaches may be qualified as “trained” or “qualified,” having completed suitable qualifications issued by their MNA or in other countries. Training and certification typically includes valuing, interacting, leadership, problem solving, and critical thinking. An important core competency they must demonstrate is making ethical decisions. Further training usually includes qualification to operate a power boat and a VHF radio, as well as First Aid certification, including CPR, swimming and rescue.

Coaches in many countries abide by a Coaches’ Code of Conduct or a Coaches’ Code of Conduct and Ethics. Codes from several national authorities indicate that coaches are expected to adhere to the following ethical standards, amongst others:

- Respect for the rights, dignity and worth of others

- Avoidance of any form of harassment
- Accepting the guidelines and spirit of the rules
- Adherence to the guidelines laid down by their governing bodies
- Promotion of the positive aspects of the sport, and fair play
- Providing a safe environment
- Leading by example
- Integrity
- Safety
- Prohibiting drug and alcohol use

Many Codes include procedures to investigate a breach of the Code and include possible disciplinary action by their MNA based on a report of an alleged breach of the Code.

With their training and ethical principles, Coaches can be valuable partners in the efficient operation of regattas. Coaches can have a calming and steadying influence on their competitors, especially in stressful situations.

2.2.3 Parents as Supporters

Parents frequently accompany youths to regattas, particularly youth events, to serve a similar functions as coaches. Parents are a diverse group of individuals in terms of the training and the experience they bring in supporting competitors at regattas. Whilst some parents are experienced competitors, others have little or no experience and this needs to be kept in mind and are not bound by any Code of Conduct or Ethics. Their main object is to have the safety, well-being and their goals for their children foremost in mind.

Parents normally do not have the same comprehension of appropriate behaviour and attitude that coaches have.

2.2.4 Other Support Persons

Teams, such as national teams, bring other support persons who are not Coaches or parents. These persons are a diverse group of individuals in terms of roles, training and experience. They might serve as chaperones to young competitors or be more closely linked to aspects of meteorology, boat management and sailing. Depending on their experience they might not all have the same understanding of appropriate behaviour and attitude to a regatta. Those who are appointed by a Class or MNA are bound by a Code of Conduct of Ethics.

2.3 Regatta Services To Competitors

The Organizing Authority needs to provide information to competitors to assist them to prepare for the regatta. This information and entry requirements, including entry fee, are normally, these days, communicated through the event website and can include:

Location: Where the regatta will be based and the area where the regatta will be sailed.

Weather and Tides: Average weather during the period of the regatta and tide high and low water and tidal streams as well as the average air and water temperatures.

Travel: Details on travel options to the regatta site, with links to driving instructions, nearby domestic and international airports, railway stations, ferries and visa requirements.

Accommodation: Links or contact information for accommodation or billeting.

Parking: Specify the times before, during, and after the event when parking is available for trailers, vans and campers.

Pre-Regatta Site Access for Competitors and Support Persons: Provide information about any restrictions to the regatta site prior to the event and where launching and parking facilities are available.

On the Water for competitors: Provide information on the entry requirements, entry procedure, entry fees, accreditation process.

Facilities for Support Boats: Launching, Storage, Refuelling and Hauling Out:

Provide information on launching, storage or berthing facilities, refuelling, and haul out facilities for support boats. Requirements for pre-registration and accreditation provides the Organizing Authority with estimates of the numbers of support boats to accommodate on site.

Insurance: Most countries and regattas require competitors and coaches to have third party insurance cover and these limits, including the currency of the policy, should be stated.

Sailing Instructions: Ideally, where possible Sailing Instructions should be available for download from the regatta website at least 3 days prior to the start of the regatta, but a hard copy must always be given to the competitor at registration.

2.4 Initial And Daily Briefings For Competitors And Support Persons

Normally hold a briefing of competitors before the first day of racing. Support persons competitors should also be encouraged to attend. It is also becoming common practice for a daily briefing to be held which provides additional information to competitors and support persons and provides information on what the race committee intend to do on that day. The general tendency these days is that at the subsequent daily meeting Support Persons attend and then pass on the information at the subsequent Team Meeting.

Briefings provide an opportunity to establish communication among the organizers, race officials, competitors and their support people and to introduce the race officials involved with the regatta. A well prepared briefing by officials consolidates the foundation for good communication and is the officials' opportunity to make a good impression and to assure all present that they are knowledgeable, approachable, friendly and sympathetic to the competitors.

The initial briefing provides competitors and their support people with details of the officials they need to approach for help to resolve any problem throughout the regatta.

The briefing for support people leaders would:

- Introduce the key race officials such as the PRO, Measurers, Jury or Umpire Chairman, and Jury/Umpire Team members;
- Identify Race Committee vessels, jury boats and umpire boats;
- Highlight any local harbour navigation rules, hazards and customs;
- Indicate some of the Race Committee's intentions in the event of certain weather conditions, local shipping movements etc.;

- Request that support teams comply with any support boat instructions in the sailing instructions or other documents. This could include the display of national identification on the support boat;
- Provide details of the role of Coach boats in the on-the-water safety plan;
- Remind competitors that sailing is a self policing sport, and of their obligations under “Sportsmanship and the Rules”;
- Advise competitors that they may approach any the members of the measurement team, Race Committee, umpires and jury at any time except when racing is taking place, on or off the water;
- Invite Advise the policy on observers to protest hearings.

Other parts of the Race Officials’ Manuals include other items that could be covered at this briefing.

An appropriate Sailing Instruction wording could be:

Coaches and Team Leaders Meeting

There will be a Coaches and Team Leaders meeting at xxxx hours each morning, or 2 hours before the first warning signal of the day if the race schedule is changed to start earlier. The objectives of the meetings are to receive feedback from the coaches on the regatta organization, exchange view points, and inform the coaches about any changes in the sailing instructions and regatta organization in general.

The briefing does not replace the official communications to competitors posted on the official notice board. Competitors who do not have coaches should also attend.

Topics that can be addressed at daily meetings usually include:

Regatta Logistics

- Parking, local community issues, medical services, catering, social events, transport, launching and retrieving, opening and closing ceremonies, notice boards, race office, jury/umpire office locations
- Safety_Management: On-the-water safety covering bad weather, towing of boats, leaving boats unattended and radio channels
- Racing_Logistics: Weather forecasts, course areas, race officer intentions in the event of no wind, or other matters influencing the scheduling of races, staying on shore .
- Equipment: Where boats are supplied by the organising authority, equipment substitution, boat allocation, trash and gear boats on the water
- Drawing attention to any information for competitors published by the jury/umpires, drawing attention to matters of concern, e.g. support boats entering racing exclusion zones, boats who have finished crossing racing areas of boats still racing.
- Feedback: Raising any issues and making suggestions for improvements for this and future events.

These meetings are normally run by the Organizing Authority and include at least the PRO and the Chairman of the Jury or Chief Umpire. It is good practice for all Race Officials to attend these meetings, if possible.

2.4.1 Other Communications during the Regatta

Depending on the nature of the regatta, it is important to make specific provision for recognising, communicating with, and otherwise supporting support persons. Communication with support persons is made significantly easier and more effective if a relationship has been established. This is even more important at junior regattas where the role of race officials generally, and judges in particular, involve an element of education. Communication with coaches can be quite different from communication with parents, as coaches are not as emotionally involved as a parent.

Officials should not remain detached or aloof. The interaction provides further opportunities for good communication and the development of productive relationships. Be friendly and approachable at all times.

Officials should focus on making themselves visible, accessible, and approachable by the competitors and their support persons. Post a list of key officials (with photographs if possible) on the regatta notice board to make recognition easier.

When officials are ashore and are not required for official duties, they could visit the boat park, in pairs, and converse with competitors and their support persons or go to the main social area for a coffee or snack. It is strongly recommended that more than one official participates in any discussions with competitors to avoid any perception of bias, conflict of interest and various other reasons, particularly when dealing with junior competitors. This is particularly important where a competitor or their support person may have a close connection with an official because of friendship, club affiliation or nationality.

Occasionally an informal comment made by a competitor or their support person in the boat park can very useful in identifying a problem or issue that can be resolved before it escalates into a larger issue.

There are times when unofficial discussions with a coach can divert potential problems involving a competitor's behaviour that has not yet reached the stage of a gross breach of sportsmanship.

When competitors wish to speak with an official they should always be told that a support person is welcome to join the conversation. Often the answer to a competitor's question would be helpful for the all competitors to know. In these cases the official should ask for the question to be presented in writing so that they can provide an official written answer to post on the regatta official notice board. There will be times when an official is asked a question that he wishes to consider before answering. These questions are also best presented in writing so that the race official can confer with his colleagues before providing a written answer on the official notice board.

Race Officials performing their primary duty will have the opportunity to monitor competitor's compliance with the rules that apply at the regatta. Examples of such rules may include safety equipment (e.g. wearing buoyancy aid), trash disposal, and class measurement rules. If a competitor is not in compliance, generally a polite comment will coax compliance. Before the beginning of a regatta the officials will have agreed a process for protests brought by the Race Committee, Umpire, Measurers or Protest Committee. This may be to refer the intention to lodge a protest with the PRO or the Protest Committee Chairman, before formally lodging the protest.

2.5 Support Boats On The Water

Many regattas now publish Coach Boat Regulations that apply during the event. For the purpose of these regulations, a coach boat usually includes any boat that is under the

control or direction of a person who is providing physical or advisory support to an athlete, including the gathering of data that may be used at a later time. The regulations might also apply to spectator boats if they are linked to competitors.

Coach Boat Regulations typically describe zones on the water where coach boats are allowed while racing is in progress, and describe zones where coach boats may not enter. They might also describe any restrictions on equipment that may be carried on board a coach boat and also provide a procedure for handling an alleged breach of any of these regulations.

The normal method of identifying support boats is to require them to display the national letters of the competitors they are supporting and an identification number supplied by the organisers. The numbers are needed when there is more than one support boat per country. As an example, France quite often sends regional teams to major regattas and there can be numerous French coach boats.

Where there are limited support boats available the Organizing Authority will often require in its Coach Boat regulations that coaches from more than one country share a coach boat.

Not all competitors will have support personnel on the water. The officials should ensure that they do not show favour or bias to any particular boat.

2.6 Establishing Exclusion Zones On The Water

The fairness of the competition, safety, and the facility for race officials to do their jobs requires the control of the positioning and movement of support boats around the race course. Establishing a set of clear and reasonable boundaries for support boats ensures good racing for the competitors.

It is up to classes, or the organising authority, or both, to determine the method of controlling support boats on the water. It then becomes the responsibility of the race officials to manage the positioning and movement of support boats.

“Support people typically want to observe the start then move to the windward mark to observe the mark rounding. In some circumstances, they will know how to watch races without interfering with competitors or the race management and without making excess wake as they proceed to the windward mark, particularly in light weather. Other support personnel with less experience might lack this understanding.

Zones where coach boats may not enter, often called exclusion zones, are specified in the Sailing Instructions and should be supported by a chart of the racing area showing the exclusion zones. They can vary from something as simple as “shall not go within 50 metres of boats racing”, to a much more comprehensive set of rules which could go as far as limiting support boats to a ‘box’ or specify the routes they could take from one end of the course to the other.

Particularly with multi-starts it is becoming more common for the race committee to lay a line of buoys at the side extensions of the start line and below the start line. Support boats are not allowed to be in front of these buoys.

A simple exclusion zone would require support boats to stay:

- about 50 metres behind the start line after the first Preparatory signal for all starts of a race; and

- no closer than 100 metres to the course area bounded by the windward and leeward marks and the lay lines either side or
- within 100 metres of the course a boat may sail.

More sophisticated exclusion zones can address some of these issues could include a 'box' behind the start line and 'lanes' between the top and bottom of the course. Where a trapezoid course is laid the exclusion zone should encompass the entire course areas, even if no boats are racing on the inner or outer loop at any time.

It is also necessary to establish procedures which prevent coaching on the water whilst boats are racing. Such outside assistance is difficult to detect with any certainty and to protest. This type of behaviour is best prevented by protocols, such as establishing exclusion zones on the race course, requiring each support boat to have support people of different nationalities on board, or specifying days when support boats are not permitted on the race course

Always check the class rules for any specific requirements or restrictions on support people who go afloat.

While the race committee is responsible for enforcement of exclusion zones, judges and umpires afloat are often in a better position to monitor support boats. They can carry out the task without waiting for specific requests from the race committee. It is good practice for the race committee, judges and umpires to discuss the preferred approach in advance, and any specific concerns as they arise. Planning will ensure consistency and compliance with the wishes of the organising authority. Observing adherence to the exclusion zones is secondary to the work of monitoring rule 42 under Appendix P, or of umpiring.

Be consistent in the approach to enforcement of these rules. Take care to apply the policy without showing favouritism. The only variation in enforcement would be as a result of differing circumstances that are readily understood. A polite but firm request will achieve the best result.

Should support boats fail to comply with the rules and regulations, the judges and other officials afloat are in a good location to remind the support boat of its obligations. Ask the boat to move back, or give a polite hand gesture.

Should a support boat fail to respond make a note of the country and identification number and post a notice on the notice board, for the coach to meet with the judges at the protest room or with the race officials at the race office, prior to the end of protest time that day.

2.6.1 Safety Plans Involving Support Boats Afloat

Support boats are an important, and sometimes an essential, part of the safety routine at a regatta, enhancing the safety provision at regattas. For safety plans involving support boats to be effective, there must be a commitment from them to assist when requested, an understanding of the circumstances in which such a request might be made, an understanding of 'outside help,' and good communications on the water.

Briefing support people on the safety plan and seeking their full support in the event that they are needed is critical. The safety plan should request support people to commit to provide assistance when asked to do so.

The race committee should hold a safety briefing prior to the first race and seek their assistance and suggestions on improving the plan.

A sailing instruction that restricts the placement and movement of support boats could be:

“Coach” Support Boats

Except when participating in rescue operations, all registered support boats shall be required to stay outside the areas stated in Sailing Instruction xx from the time of the preparatory signal for the first fleet to start, until all boats have finished or retired from that race; or the Race Committee signals a postponement or an abandonment of all fleets. The area where boats are racing is defined in Sailing Instruction yy. Boats are requested to monitor VHF Channel aa¹ which will be used by the race committee to request safety assistance.

Judge and Umpire boats should not tow boats to the course area before racing, even though there is no wind. However, towing boats ashore after racing in response to a request from the Race Committee is acceptable, so long as the Judge or Umpire shows no bias or preference to boats they assist.

2.6.2 Communication with Support Persons on the Water

Where practical, Race Officers should broadcast information of interest to support boats, such as intentions to lower a postponement flag, shifting of a course, and wind speed.

2.7 Judges’ Debriefings On Rule 42 Penalties

When judges are applying Appendix P it is important that competitors and if necessary, support people are aware of why the judges penalized a boat. Judges should be available to discuss the actions that led to the penalty and explain the actions of the competitor and why the penalty was given.

On days with multiple races, the judges should, when practicable, position their boats near the start line for the next race so that competitors and coaches can find them.

On single race days, or after the last race of the day, judges are best approached ashore. When the discussion is held ashore it is best practice that two judges discuss the penalty with the competitor and their coach, if available. The judge who gave the penalty should, where possible, be accompanied by a judge who was not part of the team that gave the penalty. If that is not possible the two judges on the boat should talk to the competitor. A judge should always have another judge along when talking to competitor.

For further information on debriefings of Appendix P penalties under rule 42, see the International Judges Manual.

2.7.1 Umpires’ Communications to Competitors

Between flights of match races or team races competitors or their support people might approach umpires for an explanation of penalties assigned during the flight. When time permits afloat within the schedule, umpires are encouraged to discuss the penalty to promote the competitors’ understanding of the situation. They would also hold a debriefing ashore.

¹ Not the RC’s own channel but in this day and age, unless a private channel is used, support persons quickly find the channel being used

2.8 When Things Go Wrong

There may be incidents where a support person affiliated with a competitor creates a problem at a regatta. If officials encounter such a situation, it is important to have prior knowledge of the action available to deal with the issue. The course of action to take may differ for coaches or parents, depending on the situation.

The Racing Rules of Sailing provide for hearings involving boats that are alleged to have broken a *rule*, along with provisions for penalties and exoneration. The first step to take when an incident arises is to find out which boat or boats and which competitor or competitors are affiliated with, or supported by the person. The regatta office should have a list of support boats, coaches, and personnel associated with each competitor or team.

The second step is to determine who the person is. Is the person a coach? If so, is he or she is an employee of the MNA, or a club that is a member of the MNA, or is he employed by the competitor or a group of competitors without specific affiliation? Is the person a trained or certified coach from his or her MNA? Even coaches hired by competitors are often certified by their MNA and may be governed by them. There are more processes available for investigating and disciplining a coach than a parent or other support person.

2.8.1 Procedures to investigate and penalize under the *rules*

If a support person provides outside assistance to a boat that is racing, a boat may protest her for breaking rule 41. The Race Committee or Protest Committee may also file the protest, but not as a result of information arising from a report of an interested party other than the representative of the boat herself. If the protest is upheld, the penalty to the boat would be disqualification in the race or in the race sailed nearest in time to that of the incident under rule 64.1.

Following the introduction of the Racing Rules of Sailing 2013-2016, Rule 69 states that the term ‘competitor’ is restricted to any boat owner and any crew member and does not extend to include coaches, support personnel or other non-competitors. Therefore the protest committee may not hold a hearing under this rule, nor send a report about that person’s actions to the correspondent MNA under rule 69.3.

However, the sailing instructions may include a provision stating that when the protest committee, from its own observation or a report received, believes that a coach or other non-competitor has committed a gross misconduct, including a gross breach of a rule, bad manners or sportsmanship, or conduct bringing the sport into disrepute, it will conduct a hearing following all the requirements of rule 63 and giving the alleged infraction the consideration of a party. If the protest committee decides that the support person has committed the alleged misconduct, it may request withdrawal of accreditation, prohibit access to regatta areas and regatta services, or take other action within its jurisdiction.

If a coach becomes a real problem during an event the PC should to take action, to the benefit of the competitors and the coaches who are complying with the rules. The Protest Committee should call the coach to a meeting and investigate. Then, depending on the seriousness of the offence, the Protest Committee can take different actions, i.e. report the problem to the OA and ask them, for example, a) to not to allow the coach to enter the club, or b) to remove the coaches’ accreditation, or both etc.

The Protest Committee may send a report to the MNA or to ISAF or to both, depending on the event and, if they wish, include a suggested course of action. Since all these actions cannot be taken under rule 69, the MNA is not obliged to follow the procedure stated in rule 69.3.

More detailed information concerning this can be found in Section N of the International Judge's Manual. Procedures To Follow For Breaches By A Support Person

2.8.2 Incidents Involving Parents and Other Support Persons

If an incident involving a person who is not a certified coach, such as a parent or other support person, it should be referred to the Organizing Authority for the event. In consultation with flag officers for the yacht club, action may be taken under the club's by-laws. Privileges extended to these people to be on club premises and use club facilities, such as boat launching and dockage could be reviewed.

2.9 Allegations Of Physical Or Sexual Abuse Of A Youth By A Coach, Parent, or Support Person

Any allegation of abuse of a youth must be taken very seriously, following the procedures legally required of adults in positions of responsibility, as defined within the laws of the country of the event. Youth are typically seen to be children aged 16 or younger, but each country defines its own age limits.

The laws within each country will define abuse. The following examples of legal definitions are provided as a guideline for the information of officials but are not universally accepted definitions. It is advisable to become familiar with definitions of abuse if you work at youth regattas. Refer also to the Section in each discipline manual referring to Junior Sailors, *e.g. Section D Judge's and Junior Sailors* in the Judge's Manual.

Abuse is any form of physical harm, sexual mistreatment, emotional harm, or neglect, which can result in injury or psychological damage. The four categories of Child Abuse have been described as:

- Physical Abuse occurs when the person(s) responsible for the child's care, inflicts or allows to be inflicted any injury upon the child. Behavioural or physical indications may be helpful in offering clues that a child may have been abused.
- Sexual Abuse refers to the use of a child or youth by an adult for sexual purpose whether consensual or not. Sexual abuse can also occur among children or youth where there is a lack of consent, or among children even with consent, where there is an age gap of more than two years.
- Emotional Abuse or psychological maltreatment occurs when the person(s) responsible for the child's care either subjects the child to or permits the child to be subjected to, chronic and persistent ridiculing or rejecting behaviour.
- Neglect is the result of serious inattention or negligence on the part of a child's care giver to the basic physical and emotional needs of the child. Child neglect may be easily confused with poverty or ignorance, or may be associated with parents who are overwhelmed with other problems. However, because chronic neglect results in physical and emotional harm to a child, it cannot be ignored, whatever its case. Neglect occurs when the parent(s) responsible for the child's care jeopardizes that care or well-being through deprivation of necessities.

Allegations of physical or sexual abuse of a youth competitor by a coach, parent, or support person must be handled expediently and carefully. All countries will have their own legal requirements on adults in positions of authority who receive such a report. Typically, the obligation is to notify the police and child protection services immediately. If you are at an event outside of your own jurisdiction, you may rely on local persons to help you to make the report. However; this will not relieve you of the obligation to make the required reports.

Reporting obligations for Adults who receive these reports include:

- If you have reasonable grounds to suspect that a child is or has been or is at risk of being abused or neglected, you must report your suspicions to the local child protection services.
- You should not conduct an investigation regarding the suspicion or disclosure. Any questions to the child should only clarify the nature of his or her complaint.
- Do not promise the youth that you will keep the information a secret.

Reporting requirements are clear for children aged 16 and under; all incidents of suspected physical or sexual abuse must be reported to the local child protection agency and the police.

2.10 Examples of Incidents That Have Occurred At Regattas:

- Parent sees PRO and questions whether he is happy with the quality of the umpires. He states he is phoning a senior judge to get his opinion on what he just saw.
- Parent sees PRO and questions the impartiality of a certain umpire.
- Coach physically threatens an umpire.
- Coach lies to cover up a competitor's misconduct.
- Coach verbally abuses race officials
- Parent instructs a competitor to claim redress after a race.
- Parent instructs competitor to lie at a hearing. The parent advises the competitor to say, "I overheard them planning to take me out."
- A Coach on the water continues to enter the exclusion zone during racing, disregarding the boundaries set in the Sailing Instructions and other support boats also enter the exclusion zone.
- Coach approaches the competitor protesting his competitor and advises her, "*You will be sorry if you go through with this hearing.*"
- Youth competitor is crying after being told he is being protested by another boat. Parent says to the official, "Leave my child alone," and will not let her son attend the hearing.
- Parent files a protest on behalf of his son, the competitor. Parent appears to represent the boat in the protest hearing.
- Coach insists on representing his competitor's boat in a measurement hearing.
- Parent of competitor who does not speak English insists on acting as interpreter for her son in the protest hearing where son is a party.
- The wind dies to 1 knot between races. The RC displays AP to wait for better conditions. At about 1600 hours a support boat motors through the fleet encouraging the competitors to bang their tillers on the deck. The competitors do so.

- A competitor receives a yellow flag penalty for rule 42 while racing. His father in a support boat, who is not a coach makes loud comments offending the judge. Ashore, his father makes further offensive comments to the PRO.

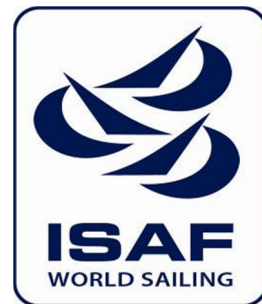

ISAF RACE OFFICIALS MANUALS

Common Section 3

Crisis Management

Contents	Page
3.1 Objectives	3 / 2
3.2 Introduction	3 / 2
3.3 Risk Assessment and Crisis Management Plan	3 / 2
3.3.1 Risk Assessment	3 / 2
3.3.2 Crisis Management Plan	3 / 2
3.4 Influence of Event Types on Safety Provision	3 / 3
3.5 Responsibilities	3 / 3
3.5.1 Competitors	3 / 3
3.5.2 Race Officer	3 / 3
3.6 Outline Structure of Safety Plan	3 / 4
3.6.1 Dinghy and Board Events	3 / 4
3.6.2 Ocean, Offshore and Yacht Racing Events	3 / 8

3.1 Objectives

The Objective of any safety policy to be adopted at an event is to provide efficient, competent safety cover thereby allowing competitors, officials and all those involved maximum enjoyment whilst minimizing the risks to their wellbeing, having regard for both expected and unforeseen conditions.

3.2 Introduction

RRS Rule 1, RRS Rule 4 and standard safety Sailing Instructions confirm that a boat accepts that it is entirely responsible for its own safety. Nevertheless, safety is an area that should be actively managed, according to 'good practice', by race officers at any event at which they are involved.

The management of safety at any one event will be governed by differing procedures dependent on many factors. These factors include the types of boats involved, the numbers of boats and competitors, the course configuration sailed, the location of the race area, the sea hazards and the conditions that competitors may experience. However, events of all types have a common initial approach to safety management - a Risk Assessment and a Crisis Management Plan. It is common practice to have the risk assessment and the crisis management plan within the same document prefixed by general information on the event and the senior officials involved.

This section outlines the various issues that concern the management of the safety resources at any specific event in order to reduce the inherent risks associated with sailboat racing to a level as low as reasonably practical (ALARP). Suggestions are made which cover most forms of racing. However, whilst these suggestions are based on models that are current practice at some events, they should be regarded as suggestions and not as guidelines that must be followed as the only means of achieving best practice. Other systems exist that are equally satisfactory. Race officers will need to address the issues applicable to their own event and adopt policies appropriate to their specific requirements.

3.3 Risk Assessment and Crisis Management Plan

3.3.1 Risk Assessment

A risk assessment must be carried out for every event so that potential risks can be identified and measures taken to minimize the risk to an acceptable level.

Each risk factor is identified and described together with its possible location. The probable consequences of the risk materialising are highlighted as are the control measures that are to be put in place in order to minimize that risk. An attempt to quantify or measure the risk, having implemented the control measures, is then made. It is likely that specific control measures will be appropriate to more than one risk factor.

The process of producing a Risk Assessment may reveal deficiencies in the anticipated safety management policy initially adopted and allows the race officer to implement further control measures to minimize the risk further.

3.3.2 Crisis Management Plan

Again, this is a document that must be produced well before the event is to take place. It defines the actions to be taken when a serious risk (as should have been identified in the

Risk Assessment) is realised. The person(s) responsible for carrying out or supervising the appropriate action is identified by name or position and relevant contact details are listed. Potential sources of outside help are also defined with contact details (e.g. rescue or emergency services, hospitals, etc). Dissemination of information after such an incident must also be managed so those responsible for this aspect should be identified.

3.4 Influence of Event Types on Safety Provision

The safety management adopted differs according to the nature of the event. Factors influencing the type and amount of safety cover provided include:

- Boat types - the requirements of keelboats, dinghies, boards and model boats are very different from those of each other. Mixed fleets often pose complex problems of safety.
- Number of boats - both the type and the amount of safety cover is often determined by the number of boats and/or competitors.
- Location of racing - the safety requirements of ocean racing differ from offshore racing, racing inland or in an estuary.
- Ability of the competitors - it is often the ability of the less able sailors in the fleet that determines the level and type of safety cover necessary.
- Age of competitors - both the young and old have greater requirements when compared to fit adults.

3.5 Responsibilities

3.5.1 Competitors

RRS 1 clearly defines the responsibility of the competitor to wear a personal floatation device, whilst that rule, in addition to RRS 4, makes it clear that it is the boat's responsibility to make the decision whether or not to race (or continue to race having started) and to carry adequate life-saving equipment for those on board. It is also mandatory for competitors to assist any person or vessel, whether racing or not, that is seen to be in danger.

Sailing Instructions will require competitors to conform to a safety system that ensures that the race committee receives confirmation that a boat either intends to race and will be on the race course or that they are safe and no longer racing.

3.5.2 Race Officer

The decision to make the wearing of personal floatation devices whilst racing compulsory is that of the race officer as defined in RRS 40, unless local regulations require a PFD to be worn at all times whilst afloat. There is therefore an implied duty of care in race management. In addition, the ISAF Code of Behaviour requires all race management personnel to be responsible for their actions concerning the safety and welfare of race participants. So whilst there may be an extensive team involved in 'safety' at an event, the responsibility for this is ultimately that of the race officer in charge even when first line management is delegated to another individual(s).

The race officer must, at all times, monitor the fleet and observe the conditions in which they are racing. Priority is always the safety of the sailors whilst their boats are of secondary importance. The timing of any intervention is also important: a capsized boat is a normal part of some types of racing and an extreme situation in others; if the race can

continue in safety without intervention then it should be allowed to do so. Rescue facilities must remain in force until all boats, racing or retired, are safely back ashore or in a safe haven such as a harbour or marina.

Medical facilities must be available either through the event itself with a doctor onsite, or through the emergency services and local hospitals. All boats involved in the management of an event should be equipped with a first aid kit as a minimum requirement.

3.6 Outline Structure of the Safety Plan

3.6.1 Dinghy and Board Events

Having completed the risk assessment the design of an appropriate safety plan is made. This is influenced by several factors.

3.6.1.1 The size and location of the race area

Racing in coastal waters and estuaries is often monitored by VHF on the main committee boat itself. Inland races can be monitored perhaps from the club office with visual contact through a window. A means of communication with the safety fleet will still be required.

3.6.1.2 Number of race areas

The requirement for a centralized system of communication and coordination of cover is determined by the number of race areas. At a major event with multiple course areas the most efficient management of the safety systems will be effected through a centralised base. Again, this could be afloat, as in the case of an event safety leader on a boat, or ashore in an office. Communication from the safety fleets to the central base is usually via VHF radio but may also be made with mobile telephones.

When racing is on a single course it is often not necessary to have a base other than the race officer in charge or a person delegated to manage the safety resources.

3.6.1.3 Mode of assistance

Dinghies and boats that are likely to capsize are best assisted by RIBs or similar small boats. It is commonplace to have a fleet that is positioned at predetermined points on the race course. A floating base such as a mothership is a useful facility to which boats that cannot cope with the conditions are tied and made safe whilst others are rescued. A patrol plan for the RIBs is essential to effect good safety monitoring and cover. This plan must be defined and understood by all safety crews to patrol effectively when boats sail out to the race area, race and return to the dinghy park. Each safety boat will have designated area to patrol during the race and during transit of boats to and from the racing area. During the races safety boats will move to a pre-

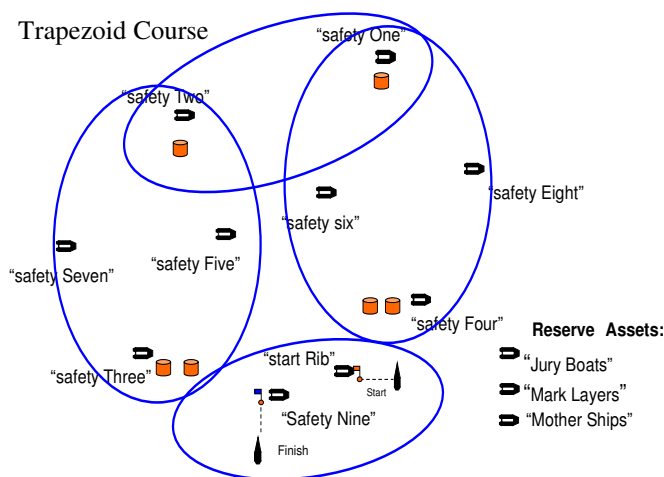

allotted patrol zone (see diagrams). Generally 1 or 2 boats would cover each leg of the course with overlapping areas around the marks. Boats should also be stationed at gybe marks as these are often problem areas. In the event of bad visibility, heavy sea, strong wind etc., boats should also be stationed at the leeward aspect of the course to 'mop up' - this is especially important if the wind is offshore. If more safety boats are available some can have a roving role.

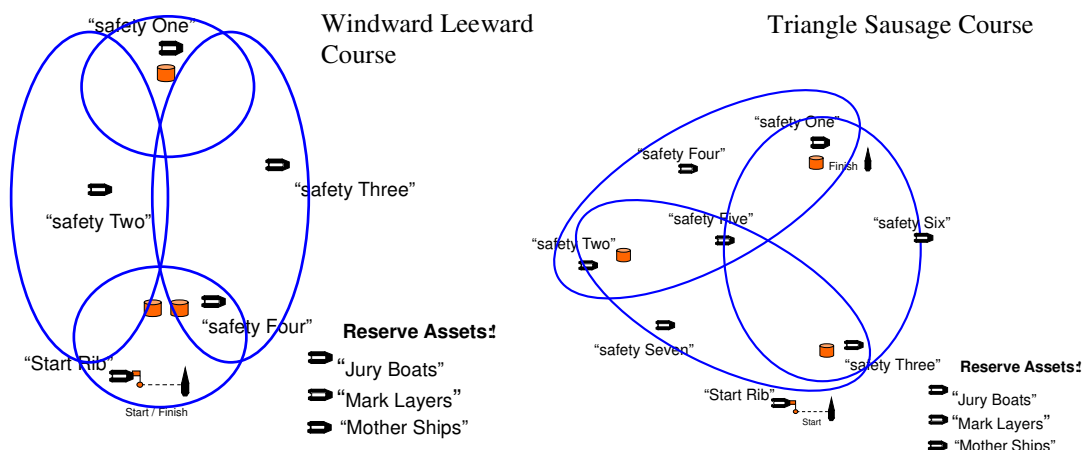

3.6.1.4 Intention to Race and Declarations

This is a requirement of the sailing instructions that enables the race officer to know who is on the water and who is on land or in harbour. In the case of dinghies and boards a tally or 'sign in / sign out' system allows the race committee to know who is on the water and who is on land.

3.6.1.5 Personnel

One individual will be assigned to the role of Safety Leader to coordinate all activity under the guidance of the race officer. There should be enough personnel in the team to provide a safety fleet appropriate to the course area, number of boats, age and ability of crews and the expected conditions. All Safety Boats should normally have a minimum of two competent adults aboard, one of whom should be dressed to enter the water to aid a rescue. There is to be no maximum number of crew but Safety Boats should not be overloaded with crew and should be able to accommodate additional sailors. It is unusual for a Safety Boat to have more than three crew members.

Other available personnel at the event should be available to help with safety issues when directed by the race officer - Jury / Umpire / Measurer / Coaches. This is not only limited to adverse conditions. Towing boats back to harbor could also be required.

3.6.1.6 Equipment

VHF radios and mobile telephones are necessary for dinghy racing.

Safety boats for dinghy events also carry:

- Adequate fuel.
- A sound generator (whistle or fog horn).
- Compass
- Anchor and warp suitable for the race area.
- Sharp knife, preferably serrated and easily accessible.

- Kill cord and spare, which must be used by the driver at all times when underway.
- Personal buoyancy for the crew, to be worn at all times.
- Safety Tape to identify abandoned boats (to be issued by the ESO).
- Paddles and bailer.
- Drinking Water.
- Tow rope (preferably made of floating line) and towing bridle.
- Waterproof first aid kit and survival bag or thermal protective aid.
- Distress Flares:- 2 orange smoke and 2 pinpoint red or 2 day/night flares.

In addition it may be desirable to carry:

- Wire Cutters, to cut away rigging and trapeze wires
- Tool kit
- GPS location equipment
- Torch
- Spare radios

3.6.1.7 Communication

Good communication is essential between all involved in any safety plan and, of course, the competitors themselves. Good briefings should be made by the race officer to the competitors before racing takes place and to the safety personnel, usually on a daily basis.

Where VHF radios are to be used it is important that all users are able to communicate effectively when the conditions are poor, which is when the activity of the safety team may be at its greatest. Wind noise is the curse of good communication by VHF so it is important that users are familiar with good technique. Call signs should be listed, VHF channels assigned and adhered to, with reserve channels should a carrier exist or when other users outside of the event also need significant 'airtime'. A procedure for radio checks is necessary.

3.6.1.8 Emergency Guidelines

In the event of an emergency occurring (including severe injury to a sailor or event personnel or structural damage endangering the safety of a boat in the event), the first boat on the scene at a dinghy event, should inform all stations using a predetermined code (such as 'Code Red') and the location of the incident. The code itself is to be defined in the safety plan and emphasized at the briefings. An immediate assessment of the situation by the race officer is made and if appropriate the incident plan then becomes active.

If the situation is considered to be hazardous to the rest of the fleet the race officer may elect to stop racing by either shortening course or executing an abandonment as appropriate.

An emergency is only declared closed when the situation has been resolved. The race officer will only then inform all stations that 'CODE RED' is cleared.

3.6.1.9 Other Issues

The following issues need to be considered as core to safety management:

- a system with which to identify boats with crews removed such as marking with streamers.
- contingency plans for a change in conditions including the onset of fog.
- a liaison with shore-side facilities and emergency services to cope with medical emergencies and injuries including a designated point for landing such incidents.
- a policy for identifying and assisting crew at a capsize and when to intervene.
- knowledge of the boats racing and how to right a capsized boat of this type (often best obtained from coaches of the class concerned).

3.6.1.10 Safety Briefings

It is important that the safety team is briefed before the event commences and also on a daily basis. The latter is to ensure that the safety personnel work as a team and refine techniques as the event progresses. Whilst the RO is responsible for safety it is common practice for the safety officer to lead these briefings, but always with the RO present. At the initial briefing the following issues need to be addressed:

- introductions of the RO and other key people.
- any local hazards.
- the ability of the competitors racing.
- the tally system in place.
- the system used to identify boats that have had their crews removed such as marking the dinghy or board with streamers.
- the location of the mothership if one is available.
- the contingency plans for a change in conditions including the onset of fog and the use of GPS.
- the methods for dealing with injuries and medical emergencies.
- the location for landing injuries and medical emergencies.
- the method to be used to patrol effectively whilst sailing out to the race area, during the race and whilst returning to shore.
- the policy for dealing with capsizes and when to intervene.
- the correct method of righting a capsized boat of the type this safety team is responsible for (and those on other course areas if appropriate).
- the VHF channel to be used and backup channels should the main one become blocked.
- the correct method for using a VHF particularly when conditions are poor with strong winds.
- the definition of when and what to transmit on the VHF particularly if there is only one channel for the course area concerned - no chatter particularly during the start sequence.
- the policy for standing down at the end of the day.
- the times of daily briefings and debriefings.
- the collection and distribution of refreshments to take out on the water.

3.6.2 Ocean, Offshore and Yacht Racing Events

The basic concepts of safety remain the same as with dinghies and boards but there are other issues to take into account.

3.6.2.1 The size and location of the race area

Course areas are extended and may be out of sight if land. Offshore racing requires a 'base' that is responsible for monitoring the location and progress of those boats involved using all technology available - tracking devices and satellite communication systems when boats are likely to be far apart; VHF monitoring both by the competitors themselves and/or a 'base' when racing is likely to be relatively compact. The base will be either afloat, as in the case of a mothership, or on land. Whatever system is used it must have the ability to communicate with both the competitors and land based rescue services. Clearly this type of monitoring must exist at all times whilst racing is taking place so is likely to be a 24 hour watch from the start and until all boats have reached a harbour or other safe haven.

3.6.2.2 Mode of assistance

The delivery of assistance to competitors is determined by the types of boats racing. Large yachts are self sufficient to a certain extent until they require the services of specialist rescue services such as is offered by coastguard agencies. In the case of injury to competitors on such yachts, they are often safer and more comfortable remaining on the yacht than being transferred to another vessel or RIB. Urgent attention is best effected by helicopter transfer.

3.6.2.3 Intention to Race and Declarations

This is a requirement of the sailing instructions that enables the race officer to know who is on the water and who is on land or in harbour. Again, it is dependent on the type of boat involved.

Yachts - common policy is a requirement that boats sail close to the main committee boat in the pre-start period and call the race committee by VHF when retiring from a race or returning to harbour prematurely. Prompt submission of paper declarations after racing is a common alternative.

3.6.2.4 Personnel

Fewer personnel are involved in safety for yacht and ocean racing. The skills of those involved are different, the main ability being communication and organisation - to alert the rescue services as is appropriate and coordinate activity where necessary whilst maintaining contact with the competitor and keeping them informed as to progress being made.

3.6.2.5 Equipment

The equipment required for ocean racing is limited to tracking devices, satellite communication systems and VHF radios. VHF radios and mobile telephones are necessary for inshore yacht racing.

3.6.2.6 Communication

Good communication is essential between all involved in any safety plan and, of course, the competitors themselves. Good briefings should be made by the race officer to the competitors before racing takes place. This is sometimes in the form of 'competitors'

notes' when boats are not located in the same place and arrive at the race area from many different locations.

3.6.2.7 Emergency Guidelines

In the event of an emergency occurring, the competing yacht should inform all stations using a predetermined code (such as 'Code Red') with incident details including its location.



ISAF RACE OFFICIALS MANUALS

Common Section 4

Race Officials and Junior Sailors

Contents	Page
4.1 Introduction	4 /2
4.2 Definition of Junior Sailors	4 /2
4.3 Race Officials Role at Junior Regattas	4 /3
4.4 Visibility	4 /3
4.5 Communication With Sailors an4 Their Coaches	4 /4
4.6 Protests	4 /4
4.7 Observers	4 /4
4.8 Use of the Protest Flag	4 /5
4.9 Reporting to the Race Committee At The Finish	4 /5
4.10 Arbitration	4 /5
4.11 Rule 42 and Appendix P	4 /5
4.12 Regatta Briefings	4 /6
4.13 Parents, Coaches and Club Support	4 /7
4.14 Support Boats	4 /7
4.15 Rule 69 Gross Misconduct	4 /7
4.16 Sailor’s Ethics	4 /8
4.17 Legal Obligations of Child Protection	4 /8
4.18 Outside Assistance	4 /9
4.19 ISAF Introductory Rules of Racing	4 /9
4.20 Sailing Instructions	4 /9

4.1 Introduction

Junior sailors comprise a major group of participants in our sport.

This section helps all race officials, but mainly judges, understand their role in the development of a child/young person centred philosophy that ensures that all junior sailors receive the greatest possible value from their participation in the sport and are encouraged to remain sailing over a long period of time. It touches on issues arising in events ranging from local club racing to international events which pose unique cross-cultural challenges and opportunities.

It is important to realise that young sailors have varying needs and interests. As a race official, you will appreciate and respect that junior sailors will be at very different levels of competence, experience and knowledge of the rules.

Adults at an event (including race officials) are in a position of leadership and trust and therefore have a responsibility to present the sport to the sailors in a way that maximises their participation, enjoyment, security and satisfaction. Coaches are usually present, and have multiple roles of support, not only of their sailors, but also in communications, race management, rescue and protest proceedings.

When children and young people are not protected from harm, injury, harassment, bullying or similar negative behaviour, their enjoyment of sailing is compromised and the likely result of this is dropping out of the sport.

At the same time, young sailors must learn how to take responsibility for their own safety and the safety of others.

There is also growing national and international concern about ethical issues in sport. Of particular concern are doping, child abuse, spectator violence, sexual assault and misconduct, lack of respect for race officials and other competitors and undue parental pressure on young children. These are all issues to be aware of if asked to officiate at a junior event.

Race Officials should be aware of the policies of all major junior classes from measurement to protests, which need to be observed in order for junior sailors to compete successfully in major events in those classes

4.2 Definition of Junior Sailors

The rules do not prescribe any age breakdown of junior sailors. However, certain class associations (e.g. IODA and ILCA) prescribe age groups for racing, and protest policies, based on the traditions and policies of their class.

For the purpose of this section, it is considered that junior sailors are generally aged from about 9 to 18 years old.

Research tells us that chronological age is a poor indicator of maturity, so an age dependent approach may not be good developmental practice. A more appropriate approach is to consider maturity in terms of readiness. Readiness assumes that certain conditions and/or experiences have been accumulated that allow the young person to learn new skills and take in new information. A child or young person's readiness will depend on his/her:

- physical readiness, e.g., mastery of fundamental movement skill, growth;

- social readiness, e.g., sense of self, support and encouragement from parents and friends;
- motivational readiness, e.g., expressing a desire to participate and/or learn and;
- cognitive readiness, e.g., ability to understand instruction, rules or tactics, in a relevant language.

In addition to understanding the unique behaviour of junior sailors, race officials need to understand that certain practices at major junior events (e.g. random measurement, display protest flag and report to the Race Committee) are driven by class association policies, and need to be observed to help junior sailors compete in major international events in those classes.

4.3 Race Officials Role at Junior Regattas

Race Officials have a significant role to play in ensuring the fairness of the competition and maintaining the confidence of the sailors, coaches and support teams.

Officials should take steps to break down the sometimes detached nature of being a regatta official, and not only administer the rules but also assist the sailors and their coaches by helping interpret the rules to contribute to the participants' enjoyment of the sport.

There is need for additional sensitivity in setting the tone of a junior regatta. It is important that sailors of all ages should be respected as individuals and not patronised.

Decisions and actions by officials can reinforce the need for good behaviour on and off the water and for taking penalties after knowingly infringing a rule.

Judges can also have a major impact on the future conduct of a sailor. Under no circumstances should sailors be allowed to feel that they will be allowed to “get away with” breaches of the rules – however minor – on account of their age. Strict and fair instruction at the start of a sailor’s career can have an important educational effect

4.4 Visibility

At junior regattas, race officials, especially judges or umpires, should focus on making themselves visible, accessible, and approachable by the sailors and their support teams. All the Race officials should be introduced at a coaches/sailors’ briefing so that sailors and their coaches can recognise them as the regatta progresses. It is also helpful for a list of judges, and if deemed helpful all other race officials (with photographs) be placed on the regatta notice board so that the identity of a particular official can be determined and contact arranged.

Particularly judges, but also other race officials, when they are ashore and not required for official duties, they should consider making themselves available to the sailors. This may involve visiting the boat park, in pairs, and being available for conversations with sailors, coaches or parents.

Circumstances permitting, it is recommended that more than one judge participates in discussions with sailors to avoid any perception of bias, conflict of interest and any other reason which may subsequently raise itself.

4.5 Communication With Sailors and Their Coaches

When speaking with sailors, use the sailor's name (ask if necessary). Also when explaining rules or interpretations with sailors, the judge or umpire should endeavour to use the vocabulary used in the rules and not change the language of the rules because the sailor is young. It is preferable, if available, to include the sailor's coach or parent in the conversation and ensure another judge or umpire is with you.

Sometimes it is more difficult for the measurer to be understood by the competitor and this is a case where the parent/coach must be present.

Particularly at junior regattas the race committee are often asked to explain when a competitor, who was scored OCS/BFD, was seen to be in front of the start line and how this was recorded. Similar to judges/umpires the race officer should endeavour to explain the circumstances in words appropriate to the rules but also add the other details he has and play either his digital recording or show the video of the start identifying the competitor.

If possible, the Organising Authority should have interpreters available at international events, as appropriate.

4.6 Protests

A significant area where the judges will interface with junior sailors is in the protest room. All sailors, but especially junior sailors, should expect a consistent and fair process, in a language they can understand.

The protest hearing should be formal, and the judges should be firm, respectful, and helpful to all participants.

Junior sailors may not have had previous experience in a formal protest hearing. The chairman should ensure that the parties, including their coaches, are informed of the processes that will be followed and if necessary clearly explain to the parties (and witnesses) the process, both initially and as the hearing proceeds. Asking at the start of the hearing if the sailors have experience in a protest hearing can be useful in deciding how to proceed.

To avoid misunderstanding, throughout the hearing and especially when communicating the facts found, conclusion and decisions, the judges should use the vocabulary of the rules. Judges should bear in mind that a younger sailor may not have a full understanding of the rules and procedures. For example, it may be appropriate to ask questions that use the definitions rather than the defined term. "Was your spinnaker ahead of the other boat's rudder?" may be a better question than "Were you overlapped?"

The need for one or more interpreter should be recognized and dealt with prior to hearings between sailors with no common language. Otherwise qualified parents, coaches and other team supporters may be used as interpreters

4.7 Observers

Observers at hearings should be encouraged at junior regattas. Besides coaches and parents being observers, it may also be beneficial for other sailors to observe the process (exclude any who will be a witness in the hearing). The chairman (or his designate) must make arrangements with the organising authority to have a room available that will accommodate the number of observers allowed. When the protest

committee secretary is scheduling the hearing, the parties should be made aware that observers are welcome.

The normal rules for observers will apply, and the observers should be made aware of these rules prior to the hearing starting

4.8 Use of the Protest Flag

Although the racing rules do not require a protest flag for boats under 6 metres (the size of most junior boats), certain Class Associations require that the protest flag be used, so sailors can learn the process (flag), and protested boats are more likely to know they may be subject to a protest and can take an alternative penalty. If a Class does not require a protest flag to be used a protest Committee cannot insist that a protest flag is used and the sailing instructions changed to bring a flag into play.

Class Associations of major junior classes including the Optimists, Sabots, Flying Ants, Flying 11, etc., sailed by sailors 15 and under have adopted policies on use of protest flags at major events. Other classes, e.g. Cadet and Laser 4.7 do not use protest flags

4.9 Reporting to the Race Committee At The Finish

It is helpful to the development of the sailors that they be the ones to decide on rule compliance on the course, and that the sailor decides whether to protest another boat or not. Certain Class Associations require that the sailing instructions contain the requirement (in addition to displaying a protest flag) that immediately after finishing the boat informs the Race Committee of their intention to protest and the boat protested. In their experience, this step is simple for a race recorder to deal with, and avoids the risk of coach prompted protests after the sailors return to shore. Other junior Class Association do not include such a requirement.

4.10 Arbitration

The use of arbitration at junior events should be encouraged. For a simple boat on boat protest, arbitration provides a process to resolve protests in a simpler manner and in less time. Interpreters must be provided as necessary to ensure due process, unless the arbitrator judge is bilingual.

Observers may be allowed, especially in cross-cultural settings, provided there is no risk that they will be witnesses in a subsequent hearing if the protest is sent back to the protest committee. Arbitration is less formal and therefore may be less pressure on the young parties.

4.11 Rule 42 and Appendix P

The use of judges on the water to monitor compliance with rule 42 should be encouraged at junior regattas. Not only does this help the sailors to understand the mechanics of rule 42 but the presence of judges on the water encourages compliance with other rules.

Apart from top level junior regattas, the Class/Organising Authority should consider changing the penalty for 3rd and subsequent penalties in accordance with Appendix L 14.4.. This assists the sailors in understanding what actions are prohibited by rule 42 and allows them to learn from their mistakes. Although the penalties of Appendix P may be relaxed at regattas by a change in the sailing instructions, the standard of Rule 42 compliance should not be relaxed and should be judged at a consistently high standard.

The judges must ensure that the Two-Turns Penalty (or retirement when required) is done correctly as described in rule 44.2. When a boat does not complete her penalty correctly she must be scored in accordance with Appendix P2.1. (i.e. DSQ).

Judges should make themselves available so that the sailors can discuss their actions that led to the penalty. On days with multiple races, the judges should, after completing their on-the-water judging duties, position their boats near the finishing so that competitors may find them.

On single race days, or after the last race of the day, the judges are best approached ashore before the protest hearings start. Judges must be able to explain the actions of the sailor and why the penalty was given. The judge should refer the rule that was broken and to any relevant ISAF rule 42 Interpretation. When the discussion is held ashore, after racing, the best practice is that one of the two judges from the boat, together with another judge from the team, discuss the penalty with the sailor. If the sailor has a coach or a parent present, that will usually make the situation easier for the sailor.

Before the racing starts the judges should be out on the course in their boats, visible to all the sailors. The judge boat(s) should be near the starting line so that all the sailors can see the judges are on the water and also identify the judge boats. This makes it easier for the sailors to find the judges if they wish to communicate with them.

4.12 Regatta Briefings

At the competitor's briefing the PRO/CHUMP/Chief Measurer/Protest Committee Chairman should decide who will introduce the following, as applicable to the event:

- Introduce and identify their discipline's officials;
- Make some positive comments about the club, the class and the regatta;
- State that the officials are there to serve the competitors, and that its prime role is to ensure fairness of the competition;
- Indicate the Protest Committee's intention to be afloat observing compliance with rule 42 and advise competitors when and how they can speak with judges or the protest committee;
- Remind sailors of the location of the official notice board and the location of the race office and protest hearing room;
- If arbitration will be used, briefly explain the process;
- Invite observers to protest hearings, as permitted in the rules;
- Advise sailors that foul or abusive language will not be tolerated;
- Request that support teams comply with any support boat instructions in the sailing instructions or other documents;
- Advise sailors that they can approach officials at any time (except when racing) on or off the water; and
- Remind sailors that sailing is a self policing sport, and their obligations under "Sportsmanship and the Rules".

For practical reasons (e.g. limited space, number of languages, class tradition.), normally only coaches will attend competitors briefings at large junior events. Clear instructions to coaches can facilitate good behaviour and rule observance by their sailors. It may be appropriate for available officials to attend the regular coaches briefing along with the

PRO and comment on rules observance and incidents, answer questions, solicit suggestions, and promote communications

4.13 Parents, Coaches and Club Support

Parents, coaches and club support are an important part of junior regattas and the development of junior sailing. Their involvement with the sailors should be acknowledged and supported within the bounds of fairness.

Younger competitors wanting to speak with an official should always be told that coaches and parents are welcome to join in the conversation, to assist the sailor in understanding the discussion

4.14 Support Boats

Support boats crewed by the sailor's support team are an important part of the safety routine at a regatta. Junior sailing would not be as strong as it is without these support structures. The movement and placement of support boats needs to be restricted, but can allow boats to move around the outside of the race area as long as they follow the limitations included in the sailing instructions and/or the coach boat regulations. For major events it is recommended that support boats be required to carry representatives of at least two different sailors or teams.

Should support boats fail to comply with the sailing instructions and the coach boat regulations, if applicable, the judges/umpires afloat maybe in a good location to remind the support boat of its obligations or note the identity of the coach boat, if they are busy policing the racing. It is best for the judges to avoid confrontation at the time and invite the boat's helm to meet with the judges/umpires at the protest room prior to the end of protest time that day, or if there is a gross breach to lodge a protest against the coach's associated competitors.

Not all young sailors will have support personnel on the water. The officials should ensure that they don't show favour or bias to any particular boats. Judge boats should not tow boats to the course area before racing, even though there is no wind. However, towing boats ashore after racing is acceptable so long as the judge shows no bias or preference to boats they give assistance, and provided that towing boats ashore is in response to a request from the race committee.

4.15 Rule 69 Gross Misconduct

It is important that all race officials recognise that in some cases it will be appropriate to conduct investigations and/or rule 69 hearings into allegations of bullying or abuse. If it is clear that there has been a one-off incident which can be dealt with under rule 69, then the protest committee should proceed in the normal manner with a hearing and impose the penalty it deems appropriate.

Any action beyond a warning must be reported under rule 69.1(c) to the national authority of the event location and competitor, if different.

A protest committee only has jurisdiction over the event in question from registration to prizegiving and any incidents immediately prior to or after it. It is not within the power of the protest committee to look into reports of misconduct that happened at other events, training camps, squad training etc.. Any such concerns should be reported to the appropriate national authority.

Any allegation of child abuse or neglect (no matter how or from whom received) must be referred to the event organising authority. It is important that the jury have some knowledge of the principles of the local laws and requirements for child protection. Some countries (AUS, USA and GBR for example) have very strict laws. Regardless of the extent of the local legislation the organizers should brief judges on the local protection laws.

Allegations of child abuse cannot be ignored. The appropriate local authorities must be notified promptly through the organising authority.

There may be occasions where the protest committee wishes to refer a matter to the local authorities but also wishes to carry on with its investigation into an alleged breach of rule 69. In these situations the protest committee must proceed with extreme caution and it is preferable that they take advice from the local authorities and the organising authority.

If it is clear that a reported rule 69 matter reported is not related to a separate allegation of child abuse/bullying, then the protest committee can proceed separately with the sporting misconduct complaint, if the local authorities are in agreement.

If the rule 69 investigation proceeds and results in a Hearing, there must be NO reference to the alleged child abuse/bullying.

If the local authorities are not in agreement, or they are not available, the protest committee should not proceed. It will always be open for the national authority to proceed under RRS 69.2 if the child protection matter is subsequently dropped.

The rationale is that it will not always be in the best interest of the young sailor, who chose not to report any suspected abuse, neglect or bullying, for a full rule 69 investigation to take place during a competition. At this time he or she is under pressure to perform, particularly where the alleged suspect is at the event.

The interviewing of children is best undertaken by trained personnel to in cases of alleged abuse, and most judges do not have such training. The worst case scenario that can result from an interview by an untrained person is that a race official, however well meaning and despite acting in good faith, could jeopardise a serious investigation.

4.16 Sailor's Ethics

It is often appropriate to remind young sailors of the behaviour standard that is expected of them in relation to the racing rules, and their relationships with other sailors. One national authority has produced a "Junior Sailors Ethical Guidelines" poster for display in sailing clubs and regatta venues. Protest committees have found the poster a convenient tool when dealing with behavioural matters at junior regattas.

The "Junior Sailors Ethical Guidelines" poster is available at:

<http://www.yachtingnz.org.nz/cmscontent.aspx?PageID=b23d1653-663d-4d5c-b09a-5eb7cec1f5fb>

4.17 Legal Obligations of Child Protection

The organizers of international events have an obligation, prior to the event, to inform members of the protest committee of all relevant local laws applicable to junior sailors at the venue. The chairman should address this with the organizers prior to the event

4.18 Outside Assistance

At a junior event with an experienced protest committee, the issue of safety on the water may make it appropriate for the sailing instructions to state that the penalty for breaking rule 41, Outside Assistance, is at the discretion of the protest committee. This can be helpful when, for example, a race committee or support boat has recovered and returned a crew member to a boat after falling overboard. Changing the penalty for such breaches of rule 41 permits the race committee or judges on the scene to promptly recover sailors without unduly interfering with the boat's race results. If protested, the officials performing the recovery will explain the incident to the protest committee, which may then impose no penalty or a penalty less than disqualification.

It is recommended that the Notice of Race and Sailing Instructions include the following:

Add to RRS 41: (e) help to recover from the water and return on board a crew member provided the return on board is at the appropriate location of the recovery

4.19 ISAF Introductory Rules of Racing

In order to help newcomers to sailboat racing, ISAF have produced a one page set of Introductory Rules for Racing complete with some explanatory diagrams. The aim of the Introductory Rules for Racing is simple; make it as easy as possible for people to start racing. Consequently the Introductory Rules are as basic as possible, although they remain compatible with the principles and fundamental rules in The Racing Rules of Sailing (RRS). The Introductory Rules are being developed as part of Objective 2 of the ISAF Strategic Plan to encourage new entrants to racing and to ensure the rules are not a barrier to participation. ISAF intends that people of all ages can race using these rules without needing any knowledge of the full RRS.

The ISAF Introductory Rules of Racing are available at:
http://www.sailing.org/training/newtosailing/start_racing.php

4.20 Sailing Instructions

As much as possible, sailing instructions for junior regattas should be consistent (using Appendix L or LE) across events in matters that are not regatta specific. Regatta specific clauses include start times, description of marks, racing area, location of notice board and signals made ashore location. The sailing instructions should ideally be posted on the event website at least one week prior to the event. It is not in the interest of sailors to receive a multi-page document shortly before racing begins. Young sailors should not be expected to note the sometimes subtle changes in sailing instructions when the more important activity for the sailor at that time is to prepare for racing.

4.20.1 Changes to Sailing Instructions

For junior regattas, it may be appropriate to include the following specific sailing instruction clauses:

- Changes to Sailing Instructions (modifying L3)
- Changes to the schedule of races should be posted before the end of the protest time limit on the day before the change in schedule.
- The Start
- Boats whose warning signal has not been made shall avoid the starting area during the starting sequence for other races.

- Penalty System (modifying L14, Appendix L)
- Use the modified version in L14.4 which is recommended for junior events.
- Protests and Requests for Redress (modifying Appendix L16)
- If required by policies of the Class Association or the organizers, require all boats - regardless of length to fly a protest flag when protesting.

If required by policies of the Class Association or the organizers, require that a boat intending to protest shall, immediately after finishing, in addition to the requirements of rule 61.1(a), inform the Race Committee boat at the finishing line of her intention to protest and give the identity of the boat(s) being protested. The Race Committee should note such reports on its results log.

Unless this is detailed as a requirement in the class rules, either directly in the Sailing Instructions or by inclusion on Event Rules from the class that the Notice of Race/ Sailing Instructions includes as rules for the event – it does not apply and if the requirement is written in the class rules it is not valid.

4.20.2 Support Boats (modifying Appendix L 23)

Except when participating in rescue operations, team leaders, coaches, parents and other support personnel shall stay outside areas where boats are racing from the time of the preparatory signal for the first fleet to start until all boats have finished or retired or the Race Committee signals a postponement or an abandonment of all fleets. The areas the boats are racing is defined as the area inside the course and within xx metres (to be fixed by the Race Committee pre-regatta) of any mark, lay line, starting line, finishing line or any area where any boat that is racing is sailing or may sail.

The Organizers should circulate a *safety* plan to support boats in case an emergency arises. The coaches or team leader meeting is a good opportunity to discuss the safety plan.



ISAF RACE OFFICIALS MANUALS

Common Section 5

Handling Misconduct

Contents	Page
5.1 Introduction	5 /2
5.2 When should rule 69 be used	5 /2
5.3 Who is subject to rule 69.1	5 /2
5.4 Types of behaviour justifying a rule 69 hearing	5 /3
5.5 Who may make a report	5 /3
5.6 Form of Report	5 /3
5.7 Who should the report be lodged to	5 /3
5.8 Reports lodged with organizing authorities/clubs/other authorities	5 /4
Appendix A – Examples of Gross Misconduct	5 /5

5.1 Introduction

All race officials, competitors and other personnel are entitled to be treated with fairness and respect and it is important that these principals are upheld. The purpose of Rule 69 is to have a rule which deals with a competitor who may have committed a gross breach of a rule, good manners or sportsmanship, or may have brought the sport into disrepute.

5.2 When should rule 69 be used

The sport should not tolerate bad behaviour, and action under rule 69 is a potent way of dealing with this problem. Turning a blind eye to misconduct only serves to damage the enjoyment of those who behave properly, which in turn puts people off participating in the sport.

It is the responsibility of all race officials to deal with misconduct in an appropriate and timely manner.

If in doubt, it is better to call a hearing under rule 69, and find an allegation unsubstantiated, than not to call a hearing at all.

5.3 Who is subject to rule 69.1

A 'competitor', which means the person in charge of a boat under rule 46 and any crew member.

Rule 69.1 does not apply to other people (such as coaches or parents and other persons associated with a regatta), even if associated with a competitor, but their behaviour can be reported directly to the club, class association or MNA. A MNA can hold an investigation under rule 69.2(a).

5.3.1 The extent of rule 69 jurisdiction (the time and location of the alleged misconduct)

The jurisdiction of the protest committee under rule 69 extends from the time competitors arrive at the venue until they depart.

If the competitor can readily be associated with the event, or if there is brawl in a public place between competitors, or if several competitors join together in bad behaviour, then the protest committee can take action. The important question is whether the behaviour of the competitors can reasonably be said to be associated to the event or to the sport.

When a club or event receives a complaint from someone who is not associated with the event about the behaviour of one or more competitors, this indicates that a connection has already been made and the sport in general (and the event in particular) may have been brought into disrepute.

Misconduct occurring after the end of the event, possibly even away from the event location, could be considered under rule 69 if satisfactory association to the event is established.

5.4 Types of behaviour justifying a rule 69 hearing

All behaviour must be considered in context – some types of behaviour should be treated as ‘zero-tolerance’ issues, others (such as bad language) require consideration of the context and nature of the event.

It is for the appointed protest committee to consider this however – what one race official perceives as acceptable may be regarded by others as clear misconduct. The same applies to competitors and a competitor from one culture may consider the actions or language of a competitor from another culture, on the race area or elsewhere extremely offensive.

Examples (which are by no means exhaustive) are included in Appendix **Error!**
Reference source not found..

All competitors must be treated equally.

Any decision on a competitor’s future racing is for the MNA and ISAF, if the MNA takes further action, to make.

5.5 Who may make a report

A report can be lodged by any person (who need not be a competitor). This can include:

- the race committee, or one of its members;
- the protest committee, or one of its members;
- spectators;
- passing cruising boats;
- local residents;
- the host club (if not already the organizing authority); or
- organisers or competitors of another event.

5.6 Form of report

There is no definition of the form a report must take. It may be a written or oral complaint. However, it is preferable that the report is put into writing.

5.7 Who should the report be lodged to

If a protest committee has already been appointed, then the report should be lodged with it.

However, the protest committee should involve the organizing authority at the earliest opportunity, as the hearing might better be conducted by a different or strengthened protest committee. It is for the organizing authority to appoint the protest committee who will conduct any rule 69 hearing, unless an international jury has already been appointed for the regatta.

If an international jury has been appointed, then the report should be lodged with this body and it would be the suitable body to conduct a hearing.

If no protest committee has been appointed, the report should be lodged with the organizing authority, which should then appoint a protest committee. Once appointed, the protest committee should be given the report to consider.

5.8 Reports lodged with organizing authorities/clubs/other authorities

If a report is lodged with the organizing authority, club or race committee, there is no obligation on it to refer it to a protest committee. However it is firmly recommended that they do so.

It may be appropriate for a report also to be lodged with the host club or another authority (such as a class association) for action under their own disciplinary processes.

Action under rule 69 does not preclude action by a club or other body and vice versa. However the powers of a club (which will likely include the suspension or removal of membership) are unlikely to be powers available to the protest committee.

At an event organised by a club or a class, it may be prudent and helpful for the protest committee chairman to inform a senior officer (for example a Flag Officer or responsible member of the class committee) of a potential rule 69 hearing. A constructive dialogue between race officials and the club/class is important to maintain at all events: the club/class may be able to give important background information and inform the committee of the class' disciplinary ethos.

It may be that the protest committee considers that the misconduct is best left to the club or class to deal with under their own disciplinary procedures. The committee must be confident that the club or class will take real steps to address the misconduct, as once the event ends, it will be unable to go back and investigate if matter has not been dealt with.

It must be borne in mind that it is inappropriate to discuss the specifics of a case with anyone outside the protest committee. The committee should also be wary of being told too much about the background of the competitor as this may lead it (inadvertently) to consider irrelevant information during a hearing.

A competitor can be subject to a rule 69 hearing for matters after the event, i.e. a competitor that unfairly criticises the race officials etc. on public forums after the event that brings the sport into disrepute. If the protest committee has already left the regatta site by this time this type of breach would be dealt with by the MNA under rule 69.1(d). Depending on the time frame when the same similar issues apply before the event the protest committee could deal with the allegation on site or by the MNA under rule 69.1(d).

For rule 69 procedures please refer to the Judges Manual.

APPENDIX A:

EXAMPLES OF GROSS MISCONDUCT

- 1) Engaging in any unlawful activity (e.g. theft, assault, criminal damage)
- 2) Engaging in any activity which brings the sport into disrepute
- 3) Bullying, discriminatory behaviour and intimidation
- 4) Physical or threatened violence
- 5) Deliberate damage or abuse of property (including a boat)
- 6) Deliberately disobeying the reasonable instructions of event officials
- 7) Repeated breaches of rule 2
- 8) Inciting others to break rule 2
- 9) Deliberately breaking a racing rule with the intention of gaining an advantage
- 10) Deliberate interference with another competitor's equipment
- 11) Repeating a measurement offence (intentionally or recklessly)
- 12) Lying to a hearing
- 13) Other forms of cheating such as falsifying personal, class or measurement documents, entering a boat known not to measure, missing out a mark to gain places etc.
- 14) Foul or abusive language intended to offend*

Bad language (including that not directed towards an official) has to be judged in this context. If you are uncomfortable with the language being used, then action should be taken. It is quite proper for clubs and organisers to make clear before an event that the use of inappropriate language will lead to rule 69 action. If the organisers have made this statement, then the protest committee should be prepared to enforce the standards expected. Clubs and event must set and improve their own standards.

Foul and abusive language towards race officials should be considered as dissent and forwarded to the protest committee for possible rule 69 action.



ISAF RACE OFFICIALS MANUALS

COMMON SECTION 6

Guidelines for Dealing with the Media

Contents	Page
6.1 Introduction	6 /2
6.2 Definition	6 /2
6.3 ISAF's approach to the media	6 /2
6.4 What to do and what not to do when talking to the media	6 /2
6.4.1 Do	6 /3
6.4.2 Do not	6 /4
6.4.3 Understanding how journalists work	6 /4
6.4.4 Keeping a record of press contacts	6 /5

6.1 Introduction

In this day and age where television, newspaper and internet media aim to gather news and show/publish this virtually immediately, more pressure is being laid at the feet of race officials to provide statements on what has happened during the racing or what appears *on the surface, to be controversial* decisions by the race management, umpires or jury.

Very few race officials have been exposed to dealing with the media and based on this it was decided to include in the Common Sections of the Race Official's manuals a small section which gives guidance to race officials and the notes they need to take.

6.2 Definition

Reference to media in this section refers to all types of personnel ranging from journalists writing stories for printed press and internet press to reporters producing material to broadcast on television, radio and digital media

6.3 ISAF's Approach to the Media

The approach ISAF have to the media is that the key objectives of ISAF's media programme are to:

- Promote and develop interest and participation in all types of sailing.
- Reinforce sailing as an attractive lifetime sport with a positive image that has a global reach and is universally accessible, fun and diverse.
- Promote the role ISAF plays in managing, running and developing the sport of sailing.
- To achieve this we provide relevant, interesting and varied content through our own media communications channels and work directly with sailing and other media.
- Build long-term relationships with journalists and increasing ISAF and sailings visibility through positive media coverage is important in helping to achieve these objectives.

With this approach in mind race officials should aim to follow the guidelines laid out in the following paragraphs and ensure that race officials must be mindful when they talk to the media, if it goes badly, it affects the ISAF brand.

At the initial race officials meeting each discipline should appoint a media spokesperson who is the sole person authorised to speak at media interviews or answer questions relative to that discipline. If there is a press conference all the discipline media spokespersons should be present and identified by a name plate in front of them.

6.4 What to do and what not to do when talking to the media

Remember the vast majority of media contact will be perfectly straightforward. The following guidelines should cover most situations that the race official should experience and apply to direct approaches at events or if a journalist makes contact my phone or email and will help race officials to avoid some of the difficulties you might experience in these situations.

6.4.1 Do

Try to get as much information from the media representative(s) as you can, to help both them and yourself. This can include:

- their name,
- what broadcaster, website, newspaper or magazine they are working for,
- who their audience is,
- what information they want to know,
- when their deadline is (in the case of a journalist making contact outside of an event),
- why are they producing the story/feature,
- how much information do they need (short news story or a feature?).

Offer yourself as a source of information and comment only on your area of ISAF expertise/responsibility.

If you have time constraints, tell the media representatives at the very beginning, e.g. hearings shortly starting. Similarly, ask them if they need to leave by a certain time.

Take time to educate the media representatives on a particular subject if necessary. This may well mean they come back to you in the future.

If you can, put together two or three newsworthy views/items on your subject

Prepare for any negative issues that could come to light.

Wherever possible choose somewhere to talk to the media representatives that is quiet with no interruptions and where you feel relaxed and comfortable.

Be concise. If a media representative is writing down what you are saying, they are more likely to get it wrong if you talk quickly or at length. If you are being interviewed for the broadcast media (television, radio, internet) short 'yes'/'no' answers are not very interesting and if you talk for too long people lose interest.

Be positive, passionate about sailing. Your positive attitude will reflect in what is broadcast or what a journalist writes.

Use language that you would like to hear or see in print and attributed to you.

Be natural and be yourself.

Always be calm and courteous, even if you feel angry or frustrated or if the media representative is rude.

Broadcast interviews need to be interesting/entertaining. Talk about the interview with the media representatives first to get a feel for the type of interview they want and discuss the questions with them before you start.

If you are asked a question about something you are not comfortable answering:

- In a broadcast interview simply say you cannot comment, but do not do this to all questions.
- For print and web interviews say that you cannot comment but will arrange for a suitable person to contact them. Be honest, if you do not know an answer say you will get back to the media representatives as soon as you can or will get someone to get in contact.

In a pre-recorded broadcast, web or print interview, if you are unsure if you have understood a question properly, repeat the question to the journalist in your own words to make sure that they have explained it properly.

It is all right to ask if you have answered the question adequately, but not if it is a live broadcast.

In pre-recorded broadcast interviews, it is alright to stop and ask to start again if you make a mistake.

Make a record of the contact

6.4.2 Do Not

Do not make exaggerated claims. Media representatives will always try to substantiate all claims.

Do not assume that the media representative understands the event/situation/issue as well as you do. Find out at the start what their level of knowledge is so you can give the appropriate amount of detail.

Do not say anything you do not want to see in print or broadcast. The safest rule is to regard everything you say as 'on the record', in other words will be printable or capable of being broadcast. Treat any 'off-the-record', you do not wish it to be printed or broadcast with extreme caution. Never say anything off-the-record unless you have a long-standing relationship with the media representative and have proven evidence that you can trust them. Even if you ask not to be quoted, there are no guarantees, especially if what you say is interesting or negative.

Do not go talk about aspects that you are not involved in at ISAF only talk to them about subjects you are involved in. Tell the journalist you will get the appropriate person to call back if they want to discuss a different subject.

Never make deliberately misleading statements, even to get out of a difficult situation.

Never let your guard down, even if you feel you are getting on well with the media representative.

If there is a silence, do not feel that you need to fill it. Journalists often use this as a tactic to extract more information than you want to give.

6.4.3 Understanding how journalists work

Be aware of the journalist's deadlines. If you need to get back in contact with the journalist or need to get someone else to contact them make sure you know what their deadlines are and get back in contact as quickly as possible.

Journalists generate news. Always try to present your points in an interesting way that is relevant to the context of the event/situation/issue.

Journalists like facts, figures, and interesting comments to quote in their stories, so where possible try to have some ready.

If you are being interviewed for broadcast media the journalists has to make the interview entertaining as well as interesting. They will work with you as it reflects badly on them if the interview does not go well.

Do not ask to see a draft of an article before it is printed. This infringes on the journalist's independence. A useful tactic to remember is, if the story is very technical or covers a topic that the journalist is unfamiliar with, then you can ask to see it under the pretext of offering to check the details for them.

Some journalists use tape recorders since they are more accurate than notes. This is nothing to worry about.

End the meeting by thanking the journalist and giving them telephone numbers where they can contact you and/or the ISAF media team in future.

6.4.4 Keeping a record of press contacts

Please send on the following details to newseditor@isaf.com when you have spoken to a journalist so we can keep a record of our media exposure.

- Name of the journalist
- Name of the publication
- Date of contact
- If freelance, which publication are they writing for
- Any follow up needed

If you need help contact:

Tamsin Rand – Communications Manager

tamsin.rand@isaf.com

Tel: +44 (0) 2380 635 111

Skype: tamsinrand

Daniel Smith – Website and Media Co-ordinator

newseditor@isaf.com

Tel: +44 (0) 2380 635 111

Skype: daniel.smith237



INTERNATIONAL MEASURERS' MANUAL

SECTION A

The Basics

A	The Basics	
A.1	Introduction	A 2
A.2	Meaning of Terms	A 2

A.1 Introduction

Racing of all classes of sailing boat under the **Racing Rules for Sailing** (RRS) and **Equipment Rules of Sailing** (ERS) is based on the assumption that each boat complies with its **Class Rules**, the class rules complementing the RRS-ERS by defining the boat and equipment that may be used. Normally it is necessary to measure the physical dimensions of a boat, its equipment and sails to establish if it complies with the class rules and this is the principal role of the '**measurer**'.

Measurers therefore play a fundamental role in the organisation of sailboat racing, and their ability to apply the class rules correctly and accurately is essential. Equipment must be measured for **certification** before being used for racing, but it is normally inspected at events as well. Techniques vary in general as **certification** requires derivation of actual dimensions and **inspection** means comparison with known minimum / maximum limits. The latter is one of the roles the ISAF International Measurer is expected to perform. This Manual is a guide to most aspects of measurement but focuses especially on event inspection and hull measurement, giving information firstly on good measurement practice with specific Class examples, and secondly on practical techniques and equipment for taking accurate measurements. It is meant primarily –but not restricted in any way- for use by the ISAF International Measurers.

It is essential that measurers always keep in mind that **this Manual is only a guide**, and also refers to the current class rules of the boats they are measuring. The class rules/regulations override this Manual when there is any conflict between them.

A.2 Meaning of Terms

Racing Rules of Sailing (the “rules”)

The rules used by sailboats when racing under the jurisdiction of the International Sailing Federation.

ISAF Codes and Regulations

The ISAF Eligibility, Advertising and Anti-Doping Codes (ISAF Regulations 19, 20 and 21) are referred to in the definition of Rule. They are not included in the *Racing Rules of Sailing* because they often change during the four year publishing cycle of the rules. Changes are posted on the ISAF website at www.sailing.org and through member national authorities.

Case Book (the “cases”)

The ISAF publishes interpretations of the racing rules in *The Case Book* and recognizes them as authoritative interpretations and explanations of the rule. They are based upon appeals and questions submitted to the Racing Rules Committee. They clarify the meaning of a rule or answer questions about conflicting interpretations.

The rules, changes to the rules, and Cases are adopted by the ISAF Council, based upon recommendation of the Racing Rules Committee. This means that the *Racing Rules of Sailing* and ISAF Cases are authoritative. International Judges are required to follow ISAF rules and Cases when interpreting the rules.

Class Rules

Set of class specific rules that specify a boat and its use, the crew, personal or any other equipment and its use, and any changes to the rules as permitted by RRS 86.1(c).

International Sailing Federation (ISAF)

The international body governing the sport of sailboat racing is the International Sailing Federation. It comprises member national authorities, class associations, and other affiliated organisations. Among the many ISAF responsibilities and programmes is the training and certification of International Race Officials which include International Judges, Umpires, Race Officers, and Measurers.

National Authority

The national authority is the organization that governs the sport of sailboat racing within its jurisdiction, and is a member of ISAF, as well. Many national authorities have additional responsibilities, such as cruising and powerboat racing.

National authorities often prescribe additional rules to the racing rules or change ERS rules. These prescriptions are included as rules governing sailboat racing within the jurisdiction of the national authority by the Sailing Instructions. They are rarely invoked for international events.

Most national authorities appoint a committee to hear appeals by boats against decisions of protest committees and by race committees against the decisions of protest committees. Appeal procedures vary from country to country through their prescriptions. The highest appeal authority is the national authority under whose jurisdiction the event is held. ISAF does not hear appeals.

National authorities may submit appeals that they think clarify or help interpret a rule to the ISAF Racing Rules Committee. If the committee agrees with the decision, or believes the clarification is beneficial it will accept the appeal as an ISAF case, subject to ratification by the ISAF Council.

Organizing Authority

The body that plans and runs the races or event is the organizing authority. It may be a club, a class association, a national authority, ISAF itself, or a combination of any of these. The Organizing Authority appoints the Race Committee. The Organizing Authority or the ISAF appoints the Protest Committee/International Jury.

Race Committee

The race committee is the committee appointed by the organizing authority to conduct the races. It is responsible for publishing the Sailing Instructions and for scoring. When the organizing authority has not appointed a Protest Committee or International Jury, the race committee is responsible for appointing a protest committee to conduct hearings. Members of the race committee may sit on the protest committee, except for hearing a request for redress under rule 62.1(a). In that case, the protest committee must be independent of the race committee. A protest committee that is an International Jury constituted in accordance with Appendix N of the rules shall be independent of and have no members from the race committee.

Protest Committee

The protest committee hears protests, requests for redress and alleged breaches of rule 69. It is appointed by the organizing authority or race committee. It may be independent of the race committee or a subcommittee of the race committee. It may, when meeting the requirements of Appendix N, qualify as an International Jury. From January 2009 International Juries are referred to as Protest Committees when hearing protests and requests for redress.

International Jury

An International Jury is a protest committee that meets the requirements of Appendix N of the rules. It is appointed by the organizing authority and subject to approval by the national authority if required under their Prescriptions. It is completely independent from the Race Committee.

An International Jury is composed of experienced sailors with excellent knowledge of the racing rules and extensive protest committee experience. Its membership is made up of people of different nationalities, the majority of whom shall be ISAF certified International Judges. Provided that it conducts itself in accordance with the procedures described in Appendix N, as stated in Rule 70.5 its decisions shall not be subject to appeal.

Equipment Inspector, Measurement Committee, Measurement-related Authority

The organizing authority of a major event may appoint –through the Race Committee- an equipment inspector (event measurer) or a measurement committee to inspect boats and check compliance to the measurement rules before the start of the competition, and carry out checks (such as sails set within limit marks, distribution of ballast, weight of clothing etc.) during the competition.

If during a hearing the protest committee is in doubt about the meaning of a measurement rule, it shall refer the question, together with the relevant facts, to an authority responsible for interpreting the rule, and is bound by the authority's decision. Class Rules Authority is the body that provides final approval of the class rules, their changes and class rule interpretations. Class rule interpretation procedures are defined in ISAF regulation 10.12, unless otherwise provided for in the ISAF-Class agreement defined in Regulation 10.3.

According to the ERS, Certification Authority is the body who manages certification as follows:

For hulls, it is the ISAF, the MNA of the owner, or their delegates.

For other items, it is the ISAF, the MNA in the country where the certification shall take place, or their delegates.

However, a number of Classes are the certification authorities themselves (e.g. FD)

Official Measurer, National Measurer, International Measurer.

The term 'measurer' is a term often used to describe a person who performs either certification control or equipment inspection or both. However, it must be made clear that people performing equipment inspection at events should be called "equipment

inspectors”, and those who perform certification control should be called “official measurers”. The title 'national measurer' is given to a suitably qualified person by a national authority that runs a 'national measurers' scheme and usually refers to official measurers. The title of 'International Measurer' is awarded by ISAF to a person who meets the criteria set out in the ISAF regulations.

Race Officer, Principal Race Officer, National Race Officer, International Race Officer.

The race officer is the person in charge of running the sailing race. A principal race officer is a person who is in charge of two or more courses at a regatta. The title “national race officer” is given to a suitably qualified persons by a national authority. The title of “International Race Officer” is awarded by ISAF to a person who meets the criteria set out in the ISAF regulations

Judge, National Judge, International Judge

The term 'judge' is a term often used to describe a member of a protest committee who participates in decision making. The title 'national judge' is given to a suitably qualified person by a national authority that runs a 'national judges' scheme. The title of 'International Judge' is awarded by ISAF to a person who meets the criteria set out in the ISAF regulations.

Umpire, National Umpire, International Umpire

An umpire is a specially trained judge who makes decisions on the water, and may impose penalties, during a match or team race. Umpires may be called upon to hear protests during match racing and team racing events, as well.



INTERNATIONAL MEASURERS' MANUAL

SECTION B

ISAF International Measurers Programme

B	ISAF International Measurer Programme	
B.1	International Measurer (IM)	B 2
B.2	Terms of Appointment	B 4
B.3	Applications for Appointment and Re-appointment	B 4
B.4	General Qualifications required of all International Race Officials and Additional Qualifications for an International Measurer	B 5
B.5	Considerations for Appointment	B 6

B.1 International Measurer (IM)

Since 1980 the IYRU (now the ISAF) has acknowledged measurers who have a particularly wide experience and knowledge of a class by recognising them as International Measurers. Through the years, ISAF has expanded this practice and now has certification programs which include judges, measurers, umpires, and race officers. Training and certification of sailboat racing officials and administrating the Racing Rules of Sailing are recognised as a core purpose of the International Sailing Federation.

IMs are authorized to inspect prototype boats and qualified to lead and manage equipment inspection at the major international events for their classes. They need to have thorough knowledge and understanding of the ERS –and are tested on that as part of their appointment procedure- and they are trained by ISAF in both measurement and inspection techniques which are not class-specific. While they are regarded as Class experts, they are also capable of working outside their Class when needed. Since 2012, ISAF Rating Systems are considered as “Classes” and can have IMs appointed.

IMs should have a good understanding of racing and how sailors use and modify their equipment, they should have a solid technical knowledge of boats and how they are built as well as how to read and understand technical documents and drawings. They must have the practical skills to build accurate templates and tools to measure hulls rigs, sails and appendages. It is important that they have a “judicial” temperament as they will be working long hours in difficult conditions in a boat park and will be expected to be patient and understanding with a wide variety of individuals including sailors, other race officials, parents and coaches in a pressure filled environment. They will also be managing a group of assistants who may not have much experience.

They will be expected to be proficient in English and understand and support the policies of ISAF as well as contribute to the development of training programs for other measurers within the ISAF, their Class and their MNA. They form the backbone of their Class technical structure, providing feedback and advice on the Class rules effectiveness and application and in many cases they do the same within their MNA, for example in technical or race officials committees.

The IM’s programme is administered under the authority of the Race Officials Committee through its respective sub-committee, the International Measurers Sub Committee. Its responsibilities are stated in ISAF Regulations 6.9.8, and 31 which are reprinted below.

6.9.8 International Measurers Sub-Committee

Constituting the committee

6.9.8.1 The International Measurers Sub-committee (IMSC), which shall be responsible for administering the International Measurers programme, has been established by the Council as a Sub-committee of the Race Officials Committee (ROC) pursuant to Article 42.

6.9.8.2 The International Measurers Sub-committee shall consist of a Chairman and the number of members that shall be appointed by the Council from time to time as provided by Article 42.

Terms of reference

6.9.8.3 The International Measurers Sub-committee shall:

- (a) administer the International Measurers Programme including the review and maintenance of high standards of equipment inspection and uniform application of ISAF standards by International Measurers at events;***
- (b) recommend to the Race Officials Committee the appointment of International Measurers in accordance with these Regulations;***
- (c) with the help of the Chief Measurer / Secretary General, disseminate information to and communicate with International Measurers and Member National Authorities;***
- (d) be responsible with the relevant classes for the instruction and evaluation of International Measurers and candidates to become an International Measurer, shall include:***
 - i) the development and conduct of seminars, related manuals and materials to train and qualify International Measurers and candidates to become International Measurers; and***
 - ii) the formulation of the examinations which applicants must pass to qualify as International Measurers and, if required, the establishment of the criteria for a performance assessment and its administration;***
- (e) assist Member National Authorities in training and in developing national measurer / equipment inspector programmes;***
- (f) recommend policies regarding the conduct of International Measurers;***
- (g) administer programmes to promote uniform application and consistent interpretation of the Racing Rules and other ISAF documents by International Measurers;***
- (h) propose rule changes and submit interpretations of the Racing Rules and the Equipment Rules of Sailing to the Racing Rules Committee, the Race Officials Committee and the Equipment Control Sub-committee and other appropriate bodies;***
- (i) develop and administer a procedure for the grouping and classification of International Measurers according to their abilities and to place them in groups based on agreed criteria;***
- (j) update International Measurers Sub-committee documents, such as the Championship Equipment Inspection Report, the International Measurers Manual and the International Measurer application form and comment to the relevant committee on any ISAF document;***
- (k) address questions from International Measurers;***
- (l) deal with such matters as any ISAF Committee may request.***

International Measurers Programme Administration: See Section 3, Regulation 31

B.2 Terms of Appointment

31 International Race Officials Administration – International Judges, Umpires, Measurers and Race Officers

- 31.1 *The provisions of this Regulation affect all International Race Officials, namely International Judges, International Umpires, International Measurers and International Race Officers, referred to collectively in this Regulation as 'International Race Officials.'*
- 31.2 *The Race Officials Committee shall appoint International Race Officials after considering the recommendations of the Sub-committee that is responsible for the discipline concerned.*
- 31.3 *For the purposes of this Regulation references to 'Principal Events' shall mean those events described generally or designated as Principal Events by the Race Officials Committee and published on the ISAF Website. This Regulation shall not require the Secretary General to list each individual event.*

Term of Appointment

- 31.4 *The term of appointment for an International Race Official shall begin on the date it is made by the Race Officials Committee and,*
- (a) *if the applicant is less than seventy years old on the date of approval by the ROC, the duration of the appointment shall be four years.*
 - (b) *if the applicant is seventy years old or older on the date of approval by the ROC, the duration of the appointment shall be two years.*

In light of the decision by Council in November 2009 to modify the periods within which certain requirements must be met, the Race Officials Committee will adopt a transitional plan for applications for reappointment in 2010 through 2013 inclusive.

B.3 Applications for Appointment and Re-appointment

- 31.5 *A candidate for initial appointment shall:*
- (a) *be nominated by the candidate's Member National Authority, a Class/Owners Association or the Race Officials Committee;*
 - (b) *be recommended by the candidate's Member National Authority;*
 - (c) *send the application on the official form so that it is received by the Secretary General by 1 September; and*
 - (d) *meet the general qualifications and the additional qualifications for the discipline concerned.*
- 31.6 *A candidate for re-appointment shall:*
- (a) *apply directly to ISAF;*
 - (b) *send the application on the official form so that it is received by the Secretary General by 1 September; and*
 - (c) *meet the general qualifications and the additional qualifications for the discipline concerned.*
- 31.7 *ISAF shall inform the candidate's Member National Authority of the application.*

31.8 *On applying for appointment or re-appointment, all International Race Officials shall agree that, if aggrieved, they will resort only to the remedies referred to in this Regulation, and whether those remedies are exhausted or not, will not resort to any court or other tribunal*

B.4 General Qualifications required of all International Race Officials

31.9 *A candidate for appointment or re-appointment for any discipline shall*

- (a) *except in the case of International Measurers, be an experienced racing sailor;*
- (b) *have a sufficient knowledge of the Racing Rules and a detailed knowledge of the rules, manuals and other requirements and publications relating to his discipline;*
- (c) *be proficient in the English language and have the skills to communicate both with other race officials and with competitors on matters relating to his discipline;*
- (d) *display the temperament and behaviour expected of an International Race Official at an event;*
- (e) *have the health and physical capacity to fulfil the requirements of his discipline;*
- (f) *have the observation skills necessary to perform the duties of his discipline;*
- (g) *agree to support the policies of ISAF and further its objectives, Rules and Regulations;*
- (h) *have unimpaired eyesight and hearing, natural or corrected, at a level to enable him to carry out the duties of his discipline; and*
- (i) *be able to contribute to the development of the programme relating to his discipline.*

31.10 *Where a candidate is required to have served at an event outside of his Group or Member National Authority the following provisions shall apply:*

- (a) *If the event is the Olympic Sailing Competition or a major event as designated by Regulations 25.12.17 (a) it will qualify as such an event even if it has taken place inside his Group or Member National Authority;*
- (b) *if the candidate is from Groups A-H, the event shall be outside his Group;*
- (c) *if the candidate is from Groups I-Q, the event shall be outside his Member National Authority.*

Additional Qualifications for Individual Disciplines

31.13 *International Measurer*

31.13.1 *The appointment is made for a specific Class or Rating System. For the purpose of this Regulation a Rating System, except where otherwise stated, shall be deemed to have the status of a Class.*

31.13.2 *An International Measurer can only be appointed to a maximum of three Classes except that the Race Officials Committee may authorize additional Classes if they are very similar to measure as a Class the International Measurer is already appointed to.*

31.13.3 *A candidate for appointment as International Measurer shall:*

- (a) *have acted as an Equipment Inspector in at least two principal events (as defined by the International Measurers Sub-committee) of the Class he is applying for, within the four years prior to 14 October of the year of application;*

- (b) *have attended an ISAF International Measurer's Seminar and have passed the International Measurers written test within the last four years prior to 14 October of the year of application;*
- (c) *have an intimate knowledge of the relevant Class rules and the ISAF Equipment Rules of Sailing;*
- (d) *be recommended by the relevant Class Association or, for Rating Systems, by an ISAF Rating class, and*
- (e) *have obtained one completed IMSC reference form from an International Measurer who has served at a principal event with the candidate.*

Candidates who fail the examination may take a new examination, but not within six months after the first one, except in special circumstances. Candidates who fail the examination more than once shall be assessed on an individual basis. The decision whether to allow this or not shall be made by the International Measurers Sub-committee.

31.13.4 A candidate for re-appointment as International Measurer shall:

- (a) *have acted as an Equipment Inspector in two principal events (as defined by the International Measurers Sub-committee) within the four years prior to 14 October of the year of application; one of the events shall be of the Class or Rating System he is applying for. As an alternative, one of the events may be substituted by one hull prototype measurement of the Class he is applying for;*
- (b) *have an intimate knowledge of the relevant class or Rating System rules and the ISAF Equipment Rules of Sailing;*
- (c) *be recommended by the relevant Class Association or Rating System.*

31.13.5 An International Measurer applying for appointment to an additional Class shall:

- (a) *have acted as an Equipment Inspector in at least two principal events (as defined by the International Measurers Sub-committee) of the Class he is applying for, within the last four years prior to 14 October of the year of application;*
- (b) *have an intimate knowledge of the relevant class rules and the ISAF Equipment Rules of Sailing;*
- (c) *be recommended by the relevant Class Association or, for Rating Systems, by an ISAF Rating Class.*

31.13.6 Once appointed, an International Measurer shall not be employed by or act as a consultant to or regular official measurer at a builder for that class or Rating System.

B.5 Considerations for Appointment

31.15 Each sub-committee shall consider the following when deciding on an application:

- (a) *whether the candidate has complied with the requirements listed above;*
- (b) *any comments received by means of Regatta Report Forms;*
- (c) *the candidate's relevant experience in other disciplines; and*
- (d) *such other information as it may consider relevant.*

31.16 Candidates for re-appointment who do not meet all the requirements for re-appointment, especially in respect of events attended, may, in special circumstances or on medical grounds, be recommended for re-appointment. In those cases, the Race Officials Committee may approve either:

- (a) *re-appointment of a candidate for a full 4 year term;*
- (b) *extension of the existing appointment for 12 months;*

31.17 *Race Officials whose appointments have expired less than 12 months will be considered as candidates for re-appointment and shall meet the general and additional requirements for re-appointment for each discipline.*

31.18 *Race Officials whose appointments have expired for more than 12 months will be considered as candidates for initial appointment and they shall meet the general and additional requirements for initial appointment for each discipline.*



INTERNATIONAL MEASURERS' MANUAL

SECTION C

Qualities of an International Measurer

C	Qualities of an International Measurer	
C.1	Personal Attributes / Abilities	C 2
C.2	Code of Behaviour	C 2
C.3	Conflict of Interest	C 3

C.1 Personal Attributes / Abilities

ISAF International Measurers are expected to lead Event Inspection teams, in most cases singlehandedly without assistance from other Int. Measurers. Therefore, they must be highly skilled persons, with abilities ranging from tool handling to team management, broad knowledge on rules and experience in all aspects of racing. More specifically, an International Measurer should possess at least:

- English language proficiency, also in technical terms. This is both to be able to understand fully the class and other rules and all the technical sailboat terminology, and also to communicate efficiently with competitors, coaches and other race officials.
- Excellent measurement, hand and power tool handling skills. Apart from the obvious use of measurement tools, an IM should be able to handle at least simple hand and power tools to make templates and jigs on the spot if the need arises.
- Event inspection (Measurement Committee) experience at all levels. Experience as official Measurer is highly desirable, as well as experience in protest hearings / procedures.
- Racing experience to ensure adequate knowledge on how boats are made and used.
- Observation and listening skills, reasoning abilities, concentration and consistency, and ability to find and write facts when needed.
- Team Management and communication skills, to organize and handle the event inspection team.
- Measurer's Boat management skills.

C.2 Code of Behaviour

ISAF International Measurers are among the most exposed officials of the sport. It is therefore essential that measurers behave with the highest degree of competence, propriety and integrity, and at no time do anything to bring the sport into disrepute. An International Measurer shall follow ISAF policies, including the code of conduct below; A Measurer who does not, risks the termination of his/her appointment.

Specifically an ISAF International Measurer is expected to:

- maintain a high level of knowledge of the relevant Class and Racing Rules and the ISAF ERS as well as the Measurement Manual;
- be impartial, polite and courteous at all times. This is important not only with respect to competitors, but also to colleagues, coaches, regatta officials, hosts and other personnel involved in the administration of the regatta;
- be aware and declare any conflict of interest before accepting an invitation to become an event measurer (see below and ISAF Regulation 34);
- treat every hearing, and every other matter in which he/she is involved with care, discretion, objectivity and without prejudice; and to ensure that no personal interests affect his/her judgement;
- ensure that justice is done, and is seen to be done;
- follow the procedures in the Class and Racing Rules, and promote and support ISAF policies promulgated in these and other official publications;
- not betray the confidence of the competitors, the jury, or the builders, not to disclose anything noted at any builders premises as long as it complies with the current Class Rules, (if there is a feeling, it does not, to contact either the Class chief measurer, his

NA or the ISAF), or the jury's deliberations relating to any particular case outside the jury hearing, both during and after an event;

- not consume alcohol before or during measurement or a hearing or jury meeting and not to become inebriated at any time during an event, always acting with dignity and decorum;
- not smoke while measuring or inspecting sails, in the jury room or whilst working on a jury boat with other officials;
- be on time for measurement inspections or jury meetings and to give full attention to the matters under consideration;
- plan to remain at an event from the opening ceremony until the close of the time limit for protests after the last race and thereafter, should a measurement protest be lodged;
- wear appropriate clothing both on the water and ashore;
- not incur any more expenses than necessary- and where relevant, to reclaim only legitimate essential expenses;
- maintain a good standard of physical health, in order to maintain concentration, observation and listening skills at events that may last for several days;
- be aware of cultural differences;
- remain visible and approachable and to display the temperament and behaviour expected from an IM at an event;
- see other points of view and be diplomatic at all times;
- have the ability to make difficult decisions and be capable of handling pressure, but not to make any interpretations to Class Rules. In cases where the Class Rules are open to interpretation, the path outlined in ISAF Regulation 26.11 shall be followed;
- not give any advice to owners or builders, concerning how to affect or optimise the performance of the boat, or how to optimise the construction techniques;
- assist Class Associations in improving / simplifying their Class Rules keeping in mind: "No measurement for measurements sake".

C.3 Conflict of Interest

ISAF Regulation 34 - Conflict of Interest

- 34.1 *A conflict of interest exists when an ISAF Race Official has, or reasonably appears to have, a personal or financial interest which could affect the official's ability to be impartial.*
- 34.2 *When an ISAF Race Official is aware of a conflict of interest, he/she shall decline an invitation to serve at a regatta at which an International Jury is appointed.*
- 34.3 *When the ISAF Race Official has any doubt whether or not there is a conflict of interest, the ISAF Race Official shall promptly consult ISAF, prior to accepting the invitation and be bound by its decision.*
- 34.4 *When, at an event, an ISAF Race Official becomes aware of a conflict of interest, the official shall disclose the potential conflict to the International Jury which shall take appropriate action.*



INTERNATIONAL MEASURERS' MANUAL

SECTION D

Reserved for future use



INTERNATIONAL MEASURERS' MANUAL

SECTION E

Measurement Fundamentals

E Measurement Fundamentals

E.1	“Measurer”	E 2
E.1.1	Role of the “Measurer”	E 2
E.1.2	Qualifications of “Measurers”	E 3
E.1.3	Appointment and Authority of “Measurers”	E 3
E.1.4	“Measurer’s” Practice	E 5
E.2	Application of Class Rules	E 6
E.2.1	Objectives of Class Rules	E 6
E.2.2	Changes to Class Rules	E 7
E.2.3	Interpreting Class Rules	E 8
E.2.4	Plans – Drawings	E 8
E.2.5	Construction Rules	E 8
E.3	Certification Measurement	E 9
E.3.1	Measurer	E 9
E.3.2	Arrangement for Measurement	E 9
E.3.3	Measurement Conditions	E 9
E.3.4	Measurement Forms and Certificates	E 10
E.3.5	Recording Measurements	E 10
E.3.6	Declaration	E 11
E.3.7	International Class Fees and ISAF Plaques	E 11
E.3.8	Application for a Measurement Certificate	E 11
E.4	Measurement of Alterations	E 11
E.4.1	Replacements	E 12
E.4.2	Performance Alterations	E 12
E.4.3	Repairs	E 12
E.5	Racing Rules and Measurement	E 12
E.5.1	Measurer’s responsibility – Racing rule 78.3	E 12
E.5.2	Damage or deviations in excess of tolerances, measurement protests RRS 64.3	E 13
E.5.3	Identification on sails RRS 77	E 14
E.5.4	Advertising: RRS 80 and ISAF Regulation 20	E 14
E.5.5	Right to Protest (RR 60.2)	E 14

E.1 “Measurer”

E.1.1 Role of the “Measurer”

Boats are measured principally to establish compliance with the class rules, but there are different cases when compliance is checked and the role of the person called a “measurer” varies in each case as follows:

Measurement for Certification

Most classes require all new boats to be measured in order to establish that they have been built in accordance with the class rules before they are eligible to race. Once a new boat has been measured and found to be in compliance with the class rules it is normally issued with a Measurement Certificate which has to be retained by the owner as proof of eligibility to participate in class racing, RRS Rule 78. The procedures for measurement of new boats for certification are covered in Sections H (hulls), I (appendages), J (Rigs) and K (sails) and this task is performed by “official measurers”.

Measurement of Alterations

RRS 78 makes the owner responsible for ensuring that all alterations are in accordance with the class rules, but it is usually a requirement in the class rules that certain replacements, e.g. sails, and other alterations like significant repairs, must be measured before racing. Sometimes an endorsement is required on the Measurement Certificate, particularly if the weight has changed and weight correctors are removed or added. This task is to be performed also by an “official measurer”.

Periodic Measurement

A few classes require periodic measurement checks of boats, sometimes to check buoyancy and other safety factors or possibly to check weight of larger boats.

Equipment Inspection at an event (Regatta Measurement)

Formal inspections to check compliance with the class rules are often conducted at major competitions ranging from checking certain items only, like the weight of boats or sail measurements, to complete measurement of all competing boats. Equipment inspection is covered in Section L and also in the relevant parts of sections H, I, J and K, and is to be performed by “equipment inspectors”. In major regattas like World or Continental Championships this task ideally has to be done by the International Measurers.

Prototype Measurement

The majority of new boats are 'production' boats, i.e. they are produced in quantity by the builder to the same specification as their prototype boat rather than as a series of one-off or custom designed boats. In these cases, particularly for GRP and other moulded boats, thorough measurement of the prototype can help to minimise measurement problems with the subsequent production boats. For this reason, it is a requirement for many of the ISAF International Classes that the prototype boat (first boat out of the mould) be measured and approved before production of subsequent boats commences, and this is a task to be performed by an International Measurer.

Batch Measurement

Classes which require prototype approval sometimes reduce or even waive measurement of subsequent boats subject to full measurement being conducted on one boat from each batch, e.g. every 10th boat.

E.1.2 Qualifications of “Measurers”

The work of a measurer requires technical skills, including the ability to read and understand class rules and to apply them correctly, and the ability to take accurate measurements of length, weight and other physical parameters. Section F describes some techniques for accurate measurement, but it is essential that the measurer measures as prescribed in the Class Rules where details are given.

The measurer must be familiar with the use of standard measurement tools, and sometimes more specialised tools, as detailed in Section G. The ability to make your own special tools is also useful so that a comprehensive tool kit can be assembled to enable quick and efficient measurement/inspection. Some classes sell purpose-designed tool kits for their class.

For equipment inspection, unlike measurement for certification or of alterations where the measurer is often working on a single boat without time pressure, a measurer often has to work against the clock and the ability to work quickly as well as accurately is important. An equipment inspector may therefore be involved with the design of special equipment to speed up the process of measurement, like spar or hull measurement jigs. He will also need to be able to work as part of a team, possibly leading the team, and be able to train (non-technical) helpers to assist with measurement.

It is also essential that an equipment inspector understands the relevant parts of the RRS as, in the event of a measurement protest, the procedures given in the RRS must be followed correctly. The RRS also contain other requirements on sail markings, advertising etc. which the measurer must be aware of.

One of the best ways for a person to acquire measurement skills is to attend a regatta as a helper assisting the equipment inspectors. Most classes normally welcome offers of assistance in this area. Some classes and National Authorities run occasional seminars and courses to train measurers/inspectors.

E.1.3 Appointment and Authority of “Measurers”

Before measuring boats for any reason, a “measurer” must ensure that he has been appointed to undertake that measurement by the proper authority. The body for appointing the measurer and the authority granted to the measurer varies with the type of measurement and the National Authority (NA).

Official Measurers

For measurement for certification or of alterations, the measurer must be recognised and authorised by the body administering the class. This body will normally be the National Authority (N.A.) of the country in which the owner or builder lives, but for some classes it will be the national or international class association, and in such cases measurers may be authorised to measure by the class association (i.e. LIGHTNING, SNIPE and STAR).

Measurers are often recognized by, i.e. registered with, both the national authority and class, so that both organizations can be aware of measurement activity, however only one of these organizations will be the administering authority responsible for processing measurers' reports and issuing measurement certificates. Official measurers are not authorized to issue measurement certificates themselves but only to record measurements as required by the Class Rules and to report accordingly.

Some classes and national authorities require a measurer to have trained with an existing measurer or to have attended a seminar on measurement of the boat or to have passed a test before recognition is granted. Classes often have their Chief Measurer to co-ordinate training and appointment of measurers.

Although most are trained and authorized to measure all aspects of a boat, including sails and equipment, sometimes measurers are authorized for specific tasks only, i.e. sail measurement or hull measurement.

Equipment Inspectors

Equipment inspectors are normally appointed by a race committee (or the regatta organizers) and authorized to conduct equipment inspection checks as required by the organizers. It is acceptable for some event inspectors to be helpers with little or no previous measurement experience provided that they are overseen by experienced class measurers or national authority measurers.

An inspector is not authorized to reject an entry to a regatta because he knows, or believes, that the boat does not comply with the class rules, but he shall report the matter in writing to the Race Committee, which shall protest the boat (RRS 60.2). The procedures that must be followed are covered in Section M.

International Measurers (IMs)

Since 1980 the IYRU (now the ISAF) has acknowledged measurers who have a particularly wide experience and knowledge of the rules and a class by recognizing them as International Measurers. IMs are meant to inspect prototype boats of specific classes and to organize and lead the equipment inspection at international events for those classes. The International Measurers provide a direct line of communication from the ISAF to classes on measurement matters. International Measurers should pass on their experience and train other measurers, thereby leading to an improvement in general standards of measurement. International Measurers have the same authority as Class or National Authority measurers when measuring for certification if they are also official measurers appointed or recognized by the MNA of the country where the control takes place or that particular Class. Intimate knowledge of the ERS and of universal practices in measurement /inspection is an important part of IM training provided by ISAF. In short, IMs form the backbone of their Class technical structure, but in most cases play an important role in their MNA technical structure as well.

To be appointed as an International Measurer, the measurer's application must be supported by the relevant International Class Association, his National Authority and another IM and finally be approved by the ISAF.

Prototype Measurement

The body responsible for approving the builder subject to prototype approval is responsible for appointing the measurer for measuring the prototype. In the case of

International Classes with ISAF Licensed Builders, this body is the ISAF in consultation with the International Class Association, who will appoint somebody in consultation with the National Authority and National Class Association. The measurer appointed will normally (as per the ISAF regulations) be an International Measurer of that Class, but sometimes it can be agreed to be done by a very experienced class or national authority official measurer.

Inspections

A class administering authority may authorise a measurer to conduct an independent measurement inspection of any boat at any time if they wish to establish some information regarding compliance with the rules. The owner should be given prior notice of their intentions and should not be expected to pay for the inspection unless previously agreed.

E.1.4 “Measurer’s” Practice

A measurer should conduct his work in a professional manner to ensure that sailors have confidence in sailing administration and its officers, and to ensure that he is not open to subsequent criticism or action for failing to correctly follow the rules and procedures. The following points should be remembered:

Formalities

The general administration rules at the beginning of the Class Rules describe the procedures that measurers, builders and owners should follow for getting a boat formally measured and certified. It is important that the measurer properly understands these rules and ensures that they are applied correctly, remembering that he is acting as an agent for the administering authority.

Integrity

A measurer must be completely impartial. So as to prevent any questioning of his integrity, a measurer is not normally permitted to measure a yacht or its equipment of which he is an owner, designer or builder, or in which he has any personal involvement (e.g. if he is a member of the crew) or financial involvement other than receiving a measurement fee.

An exception to this rule is made for boat and equipment manufacturers which are licensed to measure their own equipment, with the current ISAF IHC (In-house Certification) scheme.

Measurement Fees

A measurer should require a payment for his services to a builder or owner. Some national authorities and classes lay down the fees to be charged for measurement and where this is the case that scale of fees should be the basis for the charges made. If significant travel is involved the measurer should ensure that the travel expenses are covered in addition to the measurement fee.

Travel

Most measurement for certification and alteration takes place locally to reduce travel expenses, but sometimes measurers are required or requested to measure in a country

other than their own. As a matter of courtesy, the measurer should always notify the National Authority of that country of the intended visit.

Discretion

A measurer should have respect for the feelings of an owner or builder who may have just learnt from the measurer that his boat requires substantial modification before it can be used. However, a measurer must remember that he is checking that boat for the eventual owner who will be bound by all the class rules when racing. The measurer must therefore not allow himself to be swayed by the thought that an item is not important or that it does not affect the speed of the boat, nor allow any additional tolerances outside those permitted.

Measurer's Liability

However diligent, it is possible for a measurer to make a mistake, either as a result of misinterpreting the rules or possibly a numeric error. Hopefully, careful study of this manual will help to minimise errors and any error will be minor. However, even a small correction to a boat at a later date can be a costly exercise and an owner may try to claim against the measurer.

To cover for such a possibility it is best if the measurer can have some form of indemnity insurance, and some national authorities and classes operate such a scheme.

Measurer's Reports

If measurement is to achieve its objective of establishing that a boat complies in all respects with the class rules, irrespective of whom or where the boat is measured, it follows that it is essential that the interpretation of all class rules must be uniform. Therefore, if a measurer has any doubts about the legality of any item he should report the matter to the administering authority for advice. Also, as a result of such feedback from the measurers lessons can be learnt and rules can be regularly updated and improved for the future.

A good measurer should report ideas and errors found in rules, remembering that he is part of a team of administrators who are effectively the guardians of the rules.

E.2 Application of Class Rules

E.2.1 Objectives of Class Rules

One of the most important sections of the class rules is that describing the objectives of the class and, in the case of one-designs, the rules on protection of one-designs. These rules are normally in the first few paragraphs of the class rules and explain the purpose and aims of the rules for that particular class. When applying the rules the measurer must always keep those objectives in mind.

One-Designs or Classes with closed or open Class Rules

The main objective of One-Design class rules is to ensure that the boats are sufficiently alike in performance to ensure close racing so that races are won primarily as a result of the skill of the crew. The rules of a One-Design class therefore define the hull shape and limit what may be used in the way of fittings, equipment and sails.

Each class is slightly different, but the extent of limitation of the layout and the equipment that can be used should be defined in the class rules. At one end of the scale classes allow the owner very little choice over the fittings which can be used, particularly in mass production manufacturer's classes, whereas at the other end the type and choice of fittings is extremely large.

With closed Class Rules, anything not specifically permitted is prohibited. Wherever the word 'optional' appears, then the fundamental rule is overridden and features are permitted even if not specifically mentioned in the class rules.

In the case of Open Class Rules, anything not specifically prohibited is permitted.

Development boats

Development boat classes (sometimes known as Restricted Classes) are boats built to class rules which set limits on certain parameters (like length, sail areas), and development of any ideas within these parameters is encouraged. As a result there are usually fewer measurements to be taken on a development class than on a one-design class, and the measurers should assume that anything which is not specifically prohibited is permitted, although it is essential to report any unusual or possibly undesirable features to the administering authority.

Handicap Rules

Handicap rules enable yachts of unequal performance to race together by applying handicap factors to their performance which attempt to even out the speed differentials. Some handicap rules are based on past performance of the boats, known as performance yardsticks, but other handicap rules attempt to predict performance with complicated equations using data of the physical dimensions of the boats (ORCi-IRC). In the latter case a considerable amount of measurement may be necessary to establish the required data before the handicap can be calculated.

E.2.2 Changes to Class Rules

Classes are constantly trying to improve their class rules and accordingly changes are made on a regular basis. For measurement for certification, and for measurement of most replacements, the measurer must refer to the class rules current at the time of measurement. However, hull re-measurement and measurement of repairs and rebuilds are normally to be made in accordance with the class rules that were in effect when the boat was first measured for certification. This is often known as a 'grandfather clause' and may necessitate researching to find out what the rules were some years in the past. If in doubt, then consult the administering authority.

The class rules of International Classes are published on the "Internet" by the ISAF and may be amended. Changes to the rules of International Classes may be approved by the ISAF at any time so measurers should always be aware of the procedures followed for changing the class rules of their class in order to keep up to date copies. Occasionally, class rule changes are made during the year at short notice to resolve urgent issues, so the measurer must ensure that he is on the mailing list of the relevant administering authority to receive all changes made.

E.2.3 Interpreting Class Rules

There will be occasions when the meaning of a class rule is not clear to the measurer. When measuring for certification the measurer should contact the administering authority for clarification before signing the measurement form, and describe on the measurement form what he has found, so that the administering authority can determine whether a measurement certificate is to be issued or not. For International Classes, if the administering authority is unable to determine whether the detail is acceptable it will seek an official interpretation from the ISAF or from the International Class Association in the case of a class administered by that body. As with rule changes a measurer should ensure that he will receive all official interpretations as soon as they are received.

If measurement is to achieve its objective of establishing that a boat complies in all respects with the class rules, irrespective of whom or where the boat is measured, it follows that it is essential that the interpretation of all class rules must be uniform. Therefore, if a measurer has any doubts about the legality of any item he should consult the administering authority for advice.

Sometimes, new developments, particularly control systems for sails or rigging, are seen for the first time at a regatta, having been fitted after measurement for certification. In such cases it is not always practical within the competition time scale to seek an official interpretation and the measurer, on behalf of the race committee, may have to make a temporary ruling.

E.2.4 Plans – Drawings

The class rules may refer to official plans and require the boats to be built in accordance with the plans. In these cases the measurer has to check compliance with the plans and thus he is faced with a difficulty in that tolerances cannot be given for each and every item or feature and so a judgment decision has to be made.

The criteria which a measurer should use to determine whether a boat complies with the plans should be stated in the class rules. If not, the measurer should assume as a guide that all parts of the boat have to 'look' like a boat built in accordance with the plans, i.e. that if a line is drawn as straight on the plan, then that part of the boat should be nominally straight, not curved or stepped. The degree to which this general rule applies varies greatly from class to class and the measurer should be guided by what is accepted class practice.

If a new variation from the plans is found or if the measurer is in any doubt about the compliance of a part with the plans he should refer to the administering authority. The boat must comply with any stated measurements in the class rules and with dimensions given on the plans.

E.2.5 Construction Rules

For many classes the construction rules are incorporated into the class rules and the measurer must establish that they are complied with by taking the relevant measurements. Measurement of scantlings (dimensions of the various parts of a boat's structure) can need special techniques and equipment.

For classes with GRP (glass reinforced plastic) construction there are sometimes detailed "lay up" specifications with which the builder has to comply, which may not be incorporated in the class rules available to measurers. As it is clearly impractical to

check that the specification has been followed after the boat has been built, it is usually the builders' responsibility to sign a declaration that the specification has been followed. The measurer must clearly establish from the class rules which measurements, if any, to take in respect of construction.

Instead of having defined construction rules specific to the class, some classes state that construction must be in accordance with the scantling rules of a Classification Society and may further state that a recognised Classification Society must certify that the construction was in accordance with the scantling rules. In these cases the boat may have to be built under the supervision of a surveyor from the Classification Society, and a Classification Certificate issued on completion. As this can be a costly process it is a practice normally confined to large yachts.

E.3 Certification Measurement

Many classes require all new boats to be measured to establish that they are in accordance with the class rules before they are allowed to race. When the measurement process is complete a Measurement Certificate is normally issued. This section considers the procedures normally followed.

E.3.1 Measurer

Measurement for certification is carried out by Class or National Authority measurers as described in Section 3. In some cases manufacturers are licensed to measure their own equipment (schemes of self-certification of sails in GER-AUT-NED-DEN-SWE and the ISAF IHC scheme).

E.3.2 Arrangement for Measurement

When a new boat has been completed by a builder, it may be sold as an unmeasured boat or the builder may arrange for an approved measurer to measure it for certification in order to sell it with a Measurement Form. Most classes with licensed builders require the builder to arrange measurement and sell all boats (at least the hull) with a Measurement Form.

If the boat is being sold in a part-complete state, as is often the case, for the owner to complete to his own specification, then the boat will have to be sold unmeasured, or partly measured (see E.3.4 below) and the owner will have to arrange measurement. In the case of amateur construction the same person is normally the builder and owner and is responsible for arranging measurement.

Accordingly a measurer will be commissioned by either a builder or owner and will be providing a service for that person on behalf of the Administrating Authority in return for a measurement fee.

E.3.3 Measurement Conditions

When arrangements are made and a convenient time chosen the measurer should also establish that the conditions for measurement will be satisfactory. This means ensuring adequate space, relatively level ground preferably being under cover when measuring on land, or ensuring relatively secluded calm water with good access for buoyancy or floatation measurement. If measuring a lot of boats on a regular basis for a production builder it may be possible to set up a special measurement area with measurement equipment at the ready and possibly permanent measurement jigs.

The measurer must take all measurement equipment that will be needed and will not be on hand plus notebook and documentation including the current Class Rules, RRS, ERS (if applicable), and the appropriate number of current Measurement Forms, if not supplied by the builder.

E.3.4 Measurement Forms and Certificates

The Class Rules normally refer to a Measurement Form which is a document listing all the measurements that need to be taken and, where appropriate, the maximum and minimum values permitted.

There is often confusion between the terms "Measurement Form" and "Measurement Certificate". The Measurement Form (MF) contains all the measurements taken by the measurer and a statement from the builder that the boat has been built according to the class rules and specifications.

The Measurement Certificate (MC) does not include the measurements taken. It is only a statement from the National Authority (NA), the National Class Association (NCA) or the International Class Association (ICA) that the boat has been measured by an approved official measurer, and that the boat complied with the Class Rules. A few items from the MF, like weight and corrector weights, may be part of the MC.

Most class rules state that the Measurement Form is part of the Class Rules in which case you must use an official copy, recognised by the authority for the Class Rules. It is not acceptable to make up your own Measurement Forms for certification, although you may edit a Measurement Form if corrections are needed provided reasons are given on the form for the benefit of the administration authority which has the responsibility of issuing the Measurement Certificate. Most of the measurement forms and International Measurement certificates can be loaded on the website of the ISAF or of the relevant classes.

E.3.5 Recording Measurements

A measurer is normally required to record all the measurements indicated on the Measurement Form when he undertakes measurement for certification. When recording measurements on the measurement form, it should be noted that unless specifically permitted in the class rules it is not sufficient to insert ticks or write "OK" against items which require an actual measurement.

Occasionally a measurer may mistakenly enter an incorrect measurement on the measurement form, due to incorrectly reading the measurement or due to reversing digits. Mistakes can cause considerable problems to the boat owner at a later stage, so the measurer should carefully check that all recorded measurements are within the permitted tolerances, and re-measure if necessary, before finalising measurement.

A measurer may keep a record of all his measurements by making a duplicate copy of each measurement form. This is particularly useful if he is involved with the measurement of many boats in the same class as he will be able to quickly see whether he has made a mistake in taking a measurement or whether there has been some change in boats being produced. Also, if any question is subsequently raised he can see what measurements were taken, and what comments he made.

E.3.6 Declaration

When all the measurements on the forms have been completed the measurer is required to sign a declaration on the Measurement Form. Unless the measurer has made any comments to the contrary, this signature indicates that to the best of his knowledge and belief, he considers the boat to be in accordance with all the class rules even if there are rule requirements which are not included on the measurement form.

If the measurer is in any doubt regarding the compliance of an item he must describe it in the "Remarks" section on the Measurement Form or, by reference to his administering authority obtain a further guidance on the matter before signing the form. If remarks are made the declaration should still be signed in this case indicating that to the best of his knowledge the boat is in accordance with the rules subject to remarks made. The decision whether or not to issue a Measurement Certificate then lies with the Administrating Authority.

Some Measurement Forms have space for a Builders Declaration, which normally require the builder to declare that he has built the boat in accordance with the rules. This declaration is particularly important in the case of GRP boats with construction rules with specifications for the moulding lay-ups as in such cases the measurer commonly examines the exterior of the moulding, states that 'to the best of his knowledge' it is OK based on appearance, whereas the builder actually constructed the laminate. The measurer should not sign the declaration until the builders' declaration has been signed.

E.3.7 International Class Fees and ISAF Plaques

It is common practice for a royalty to be paid to the designer of a yacht on each hull built. In the case of the classes administered by the ISAF the royalty is included in an International Class Fee (referred to as the Building Fee) which also includes amounts which go to the International Class Association and to the ISAF. A plaque is fixed permanently in the yacht to indicate that the International Class Fee has been paid. Where this is a requirement, the measurer must not sign the Measurement Form unless this plaque is fixed as required in the Class Rules.

E.3.8 Application for a Measurement Certificate

When the measurement form has been signed the form should be either sent to the administering authority or handed to the owner, as required by the class rules, to enable the boat to be registered in the class and a Measurement Certificate issued. The Measurement Certificate is the document that states the boat has been measured and found to be in compliance with the class rules. The Measurement Certificate must be endorsed by the administering authority, normally the national sailing authority. Measurement Certificates may be a separate document from the Measurement Form or may be combined with the Measurement Form (meter classes) to give easy reference to the original measurements.

E.4 Measurement of Alterations

During a boat's life there are likely to be many alterations to the original specification, as a result of replacement of items that wear, performance modifications which are permitted by the rules, repairs to damage and even major structural rebuilds. For any of these reasons it is normal for a boat to have new sails, fittings, rigging, spars, foils, structural changes, etc., after it is first measured for certification.

E.4.1 Replacements

Many items of equipment are replaced on a regular basis either because the originals are worn or damaged, or because the owner believes that a different product will improve performance. Unless the rules require measurement of replacement items then it is the sole responsibility of the owner, in accordance with RRS 78, to ensure that the equipment is in compliance with the rules, and an item that may have to be measured for certification, e.g. the centreboard, may not require measurement if it is replaced.

If the rules do require measurement of significant replacement items (e.g. sails, mast, centreboard), then they must be measured by an approved certification (official) measurer.

Replacement sails are normally required to be measured and identified by the measurer signature and stamp near the tack - see Section 15.

E.4.2 Performance Alterations

Alterations to improve performance may range from something as simple as replacing a control line or block to re-fairing the entire hull of a keelboat. Each modification, however small, can affect the compliance with the Class Rules in a number of ways and this should be born in mind when measuring. For example a change to the fittings may slightly affect overall weight. Because alterations do not require re-measurement before the boat may be raced again, alterations are often seen for the first time at regattas and can thus make regatta measurement complicated, as interpretation has to be made at short notice under pressure.

E.4.3 Repairs

Repairs roughly fall into two categories, those of a seasonal maintenance nature and repairs to structural failure of either hull or equipment. The greater the content of a repair, the greater its effect may be on the performance of the boat; accordingly some Class Rules state that 'substantial' repairs shall require re-measurement. Some rules go on to define substantial repairs but if not it is up to the owner to decide whether or not to commission a measurer to check it.

If conducting a measurement check on a substantially repaired boat it is important to check if the overall weight has changed as well as checking that the materials and shape are correct, and, if required by the class rules, to control weight distribution.

E.5 Racing Rules and Measurement

E.5.1 Measurer's responsibility – Racing Rule 78.3

This rule lays down the procedure which a measurer is to follow when he finds that a yacht does not comply with the class rules or rating certificate.

The rule reads:

78 COMPLIANCE WITH CLASS RULES; CERTIFICATES

- 78.1 A boat's owner and any other person in charge shall ensure that the boat is maintained to comply with her class rules and that her measurement or rating certificate, if any, remains valid.

- 78.2 When a rule requires a certificate to be produced or its existence verified before a boat races, and this cannot be done, the boat may race provided that the race committee receives a statement signed by the person in charge that the boat has a valid certificate. If the certificate is not produced or verified before the end of the event, the boat shall be disqualified from all races of the event.
- 78.3 When an equipment inspector or a measurer for an event decides that a boat or personal equipment does not comply with the class rules, he shall report the matter in writing to the race committee.

It is important to note that the measurer has no authority to disqualify a yacht or to rescind its entry.

A measurer is sometimes called upon to report on the circumstances of a protest to a protest committee (or to an International Jury). This report should record only the facts i.e. the measurements or details of the shape of the item concerned and, if requested, the wording of the class rules.

The protest committee may decide the protest after a hearing, if it is satisfied there is no reasonable doubt as to the interpretation or application of the class rules. However, if it is not so satisfied, the protest committee is required to refer the matter to an authority qualified to decide the matter.

The racing rules do not make it clear who such an authority is and therefore the protest committee or international jury can decide which authority it consults. ISAF Regulation 26.11 covers Interpretation Procedures but there are also Classes who follow different patterns and thus prescribe them in their Class Rules.

Suitable persons or bodies who could be considered to be qualified authorities include:

International Sailing Federation - (for International Classes administered by ISAF)

National Authority - (if that body is administering the class in that country)

Chairman of the International Class Association's Technical Committee (who should be in contact with the ISAF)

Whichever person or body is consulted it is important that they are qualified to take a decision. It is an unfortunate fact that in many cases equipment inspection at a regatta is carried out by someone who is not really familiar with the class, and while competent to measure sails, he may not be familiar with other rules governing the class.

E.5.2 Damage or deviations in excess of tolerances, measurement protests RRS 64.3

This rule specifically permits a yacht time to put right any damage or wear and tear which has caused her not to comply with her class rules, provided that her performance is not improved as a result of this.

64.3 Decisions on Protests Concerning Class Rules

- (a) When the protest committee finds that deviations in excess of tolerances specified in the class rules were caused by damage or normal wear and do not improve the performance of the boat, it shall not penalize her. However, the boat shall not race again until the deviations have been corrected, except when the protest committee decides there is or has been no reasonable opportunity to do so.

- (b) When the protest committee is in doubt about the meaning of a class rule, it shall refer its questions, together with the relevant facts, to an authority responsible for interpreting the rule. In making its decision, the committee shall be bound by the reply of the authority.
- (c) When a boat disqualified under a class rule states in writing that she intends to appeal, she may compete in subsequent races without changes to the boat, but shall be disqualified if she fails to appeal or the appeal is decided against her
- (d) Measurement costs arising from a protest involving a class rule shall be paid by the unsuccessful party unless the protest committee decides otherwise

It is a matter of judgement whether performance will have been improved but, for instance, a dinghy would normally not be disqualified if through being dragged up a slipway part of her keel band had a cross section less than that required by her class rules. Likewise a protest committee would not be expected to disqualify a yacht whose buoyancy equipment had been rendered ineffective by a collision for which she was not responsible.

E.5.3 Identification on sails RRS 77

A boat shall comply with the requirements of Appendix G governing class insignia, national letters and numbers on sails.

E.5.4 Advertising: RRS 80 and ISAF Regulation 20

A boat and her crew shall comply with ISAF Regulation 20, Advertising Code.

E.5.5 Right to Protest (RR 60.2)

When the race committee receives a report required by rule 43.1(c) or 78.3, it shall protest the boat.



INTERNATIONAL MEASURERS' MANUAL

SECTION F

Accuracy, Precision and Reproducibility in Measurement

F	Accuracy, Precision and Reproducibility in Measurement	
F.1	Introduction	F 2
F.2	Basic Standards and Units	F 2
F.3	Definition of terms	F 3
F.4	Errors	F 5
F.5	Measurement Techniques and Reproducibility	F 15
F.6	Tool certification: Accuracy & Standards	F 16
F.6.1	Mechanical tools for length measurements	F 17
F.6.2	Electronic tools for length measurements	F 17
F.6.3	Straight Edges	F 18
F.6.4	Square Edges	F 18
F.6.5	Spirit and Electronic Levels	F 18
F.7	Mass and Weight	F 19
F.7.1	Scales	F 23

F.1 Introduction

In order for measurements to be meaningful they must be accurate, precise and reproducible so that they can be repeated by another measurer at another time with similar results. There are two main elements that affect accuracy of measurement - measurers' errors and the accuracy of the equipment used.

Measurers' errors can result from misinterpreting the rules thus measuring in the wrong way to the wrong points, from miss-reading a measurement, incorrectly using measurement equipment, or as a result of incorrect recording of the data.

To avoid misinterpreting the rules the measurer must be completely conversant with the class rules and the ERS. It also helps to occasionally measure with other class measurers, at a regatta, or attend a measurement seminar to ensure that your understanding of the rules is correct. If in any doubt, contact the relevant authority for guidance.

To reduce the chances of misreading, especially if you get a deviant reading, measure twice or get someone else to re measure whenever possible, do not rush, do not measure when tired, take breaks if measuring for a long time, and if measuring with assistants give them responsibility and keep them occupied, or they will lose interest and make mistakes. It is also useful to have someone record the data on paper, as well as on a laptop, and allow the measurer to concentrate on the measurement.

Techniques for using measurement equipment correctly and precisely are covered in the next few sections, and some typical causes of error are described below.

F.2 Basic Standards and Units

Measurement

A measurement is the comparison of the quantity to be determined with a standard, and is therefore a ratio plus a unit. For accurate, precise and reproducible results the measured parameter must be precisely defined and prescriptions given for the measurement tools and procedures.

Units

Although Imperial units are still common in Naval Architecture, the Standard International (SI), i.e. metric units should be used for sailboat measurement, unless specified in the class rules. The units must be clearly stated together with the numerical value, for a measurement to be meaningful.

Unit Conversion

Length: The inch is now defined as 25.40 mm thus 1.00 m is 39.370”.

Mass: The international avoirdupois pound is defined as exactly 0.45359237 kg, So 1 kilogram equals 2.20462262 avoirdupois pounds.

Basic quantities

Table F.2.1 Fundamental quantities

Fundamental quantities	Units	Derived quantities
Length	Meter (m)	area (m ²), volume (m ³)
Time	second (s)	period (s), frequency (Hz)
Mass	kilogram (kg)	weight (N), density (kg/m ³), moment of inertia (kg·m ²)

All other mechanical quantities can be expressed in terms of these three basic quantities.

F.3 Definition of terms

Accurate and precise measurement requires:

- 1) Precise definition of the quantity to be measured.
- 2) Calibrated instruments, to ensure accuracy.
- 3) Correct procedures, designed to optimize precision and reproducibility.
- 4) Appropriate measurement facilities and conditions.
- 5) Careful record keeping and immediate comparison with the mandated value.

In daily conversation a number of terms are often loosely and imprecisely used, so some relevant terms will now be defined:

True value:

Mean of an infinite number of accurate measurements, an unattainable ideal.

The average of the measurements is a best estimate of the true value and probably within the standard deviation of the mean of the true value. For practical purposes, when discussing with the jury, the finally found value can be declared to be accurate and within the precision of the true value.

Error:

The error, or deviation, is the difference between the measured value and the true value, but as we cannot know the true value the error has to be estimated from a series of measurements and theory.

The following types of errors

- 1) Mistakes in recording or calculating results
- 2) Reproducibility, determined by methodology and stability
- 3) Round-off errors, due to poor calculation practices
- 4) Quantization, due to insufficient resolution of the measuring instrument
- 5) Incorrect measurement, e.g. LOA parallel to the deck rather than the baseline.

are generally under the control of the measurer and can be minimized by appropriate methodology and equipment. These are errors, in the sense that they are mistakes, which should be corrected.

That leaves two primary sources of error in the sense that they are deviations from the true value:

- 6) Systematic errors, which determine accuracy
- 7) Random errors, which determine precision

Accuracy:

How close the measurement is to the true value. It is a measure of the correctness of the result and is determined by the systematic errors. The use of an improperly calibrated instrument leads to inaccurate measurement, which can however be very reproducible and precise. Accuracy is determined by how well the systematic errors are treated.

Precision:

Precision is the extent to which a given set of measurements of the same quantity agree with their mean and is characterized by the scatter of successive measurements. A qualitative estimate of the precision is obtained by asking “how much would a second measurement differ from the first one?” Many calculators will give you the “standard deviation”, which is a measure of the precision for a large set of readings. Precision also depends on the resolution of the measurement device. A measurement can be extremely precise, but not necessarily be accurate.

Reproducibility:

Reproducibility is defined as the closeness of the agreement between the results of measurements of the same quantity carried out under *changed* conditions or at different locations or times. Lack of reproducibility can be due to either systematic or random errors, different measurement tools or protocols.

Round-off error:

The error in a calculation or measurement due to using only a finite number of significant digits to represent the data. With modern calculators, which typically use 9 digits, calculator round-off errors are insignificant with respect to the random errors of measurement, but the input data must have sufficient significant figures. For example $3 \times 1/3 \approx 3 \times 0.33 = 0.99!$

Significant figures:

The number of digits, including trailing zeros, used to specify a measurement. For digital instruments such as electronic scales, micrometres and watches this is the number of digits displayed. Measurements, and the results, of calculations should only be quoted to the precision of the measurement.

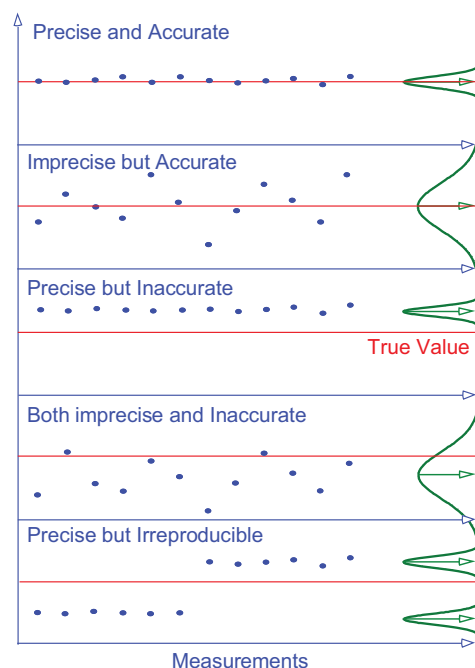

Figure F.3.1 Histograms of the scatter of many measurements of the same quantity illustrating the difference between accuracy, precision and reproducibility.

F.4 Errors

Systematic errors

These are errors which are reproducible from measurement to measurement and caused by:

- (a) Incorrect calibration or conditions of use.
- (b) Imprecise definition of the quantity to be measured.
- (c) Faulty methods or procedures.
- (d) Defective or inappropriate instruments.
- (e) Incomplete or approximate equations.
- (f) Bias on the part of the measurer.

Properties:

- (a) Cannot be reduced by averaging, as any given systematic error is reproducible and of constant sign.
- (b) Systematic errors Δ add algebraically, $\Delta = \Sigma \cdot \Delta_i$.
- (c) Can be corrected later if recognized.
- (d) They determine the accuracy of the measurement.

Examples of systematic errors:

- End hooks or damage on end of measuring tapes or rulers. These can be eliminated by using the 10 cm mark instead of the zero.
- Tension and elasticity of measuring tapes (use only calibrated steel tapes, not woven tapes).
- Stretching and distortion of templates (use Mylar for sail templates and master drawings not paper).
- Expansion due to temperature. Measuring an aluminium mast with a steel tape under a hot sun for instance.
- Incorrect calibration of scales. Zero offset, or tare, and scale factor
- Nonlinear response of scales. High precision scales require multi point calibration.

Some examples of systematic errors are:

Measurement Tape Errors

Off the shelf steel measurement tapes are surprisingly good and can be used for measurement but preferably after comparison with a certified class I tape to confirm their calibration. Every IM should have one class I measurement tape as a reference but generally use cheaper class II commercial tapes for measuring.

For measurement tapes there are three classes of accuracy: I, II, III, marked on equipment with the respective Roman numeral.

The allowed **handling error** Δ_h (mm) is twice the **certification error** Δ_c (mm), which is $[a + b L(m)]$ where L is the length, rounded up to full meters, and **a** and **b** are coefficients found in the following table F.4.1.

The quality must be such that at a deviation of temperature of $\pm 8^{\circ}\text{C}$ from the standard (normally 20°C) the change in length is within the certification error. If there is a prescribed tension, a change in the tension of $\pm 10\%$ shall not create a change in length greater than the certification error.

Table F.4.1 Measurement Tape Certification Classes

Coefficient	Class I	Class II	Class III
a	0.1	0.3	0.6
b	0.1	0.2	0.4
Length	Certification error $\pm \Delta_c$ mm		
1.00 m	0.2	0.5	1.0
5.00 m	0.6	1.3	2.6
10.0 m	1.1	2.3	4.6
Length	Handling error $\pm \Delta_h$ mm		
1.00 m	0.4	1.0	2.0
5.00 m	1.2	2.6	5.2
10.00 m	2.2	4.6	9.2

End error

If the end of the tape or rule is damaged there may be an error in the measurement. It is good practice to check that the length of the tape or rule over its first 100 mm is correct. Some measuring tapes have sliding hooks at their end, to facilitate inside and outside measurements, which are legal for all classes, but create an additional value to the certification error. Precision tapes have their zero offset from the end of the tape. A bent tape (by stepping on it) will also give wrong dimensions.

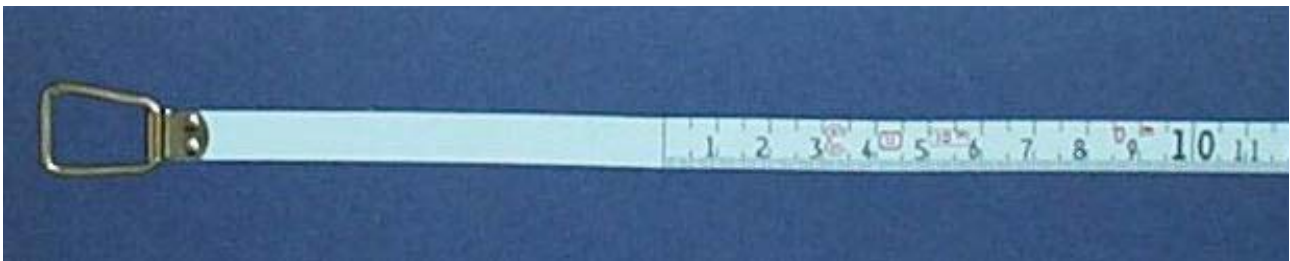

Figure F.4.1 A measuring tape with an offset zero to eliminate end errors.

Temperature errors

Measuring tapes, as well as the items to be measured, expand as they get hotter, but unless made of the same material they expand at different rates. Steel has a coefficient of expansion $C_S = 11.6 \times 10^{-6}/^{\circ}\text{C}$, while the coefficient of expansion of aluminium is $C_{Al} = 23.4 \times 10^{-6}/^{\circ}\text{C}$.

Some coefficients of expansion are given in table F.4.2:

Table F.4.2 Thermal Expansion Coefficients

Material	Coefficient $\times 10^{-6}/\text{deg C}$
Aluminium (6061)	23.4
Brass	18.7
Copper	16.6
Stainless Steel (316)	16

Steel	11.6
Cast Iron	10.5
Polyester-Glass	25 (resin dependent)
PVC	50.4
Lead	29.3

The thermal expansion of wood and plywood depends on the grain direction and humidity but is typically $5 \times 10^{-6}/^{\circ}\text{C}$. For all combinations of fibres and resins, glass, carbon etc. the coefficients depend on the type of resin and fibres and the direction of the fibres. In most cases these are more or less unknown, so in important cases where there is doubt, try to measure in the morning or evening, when the temperature is close to 20°C .

For example if a 10m long mast is measured while it is in the sun both it and the tape measure can easily reach a temperature of 40°C . The change in length of a tape measure for a deviation in temperature $\Delta T = 20$ degrees C would be $\Delta L = L(\text{mm}) \times \Delta T(\text{deg. C}) \times C_s = 2.3 \text{ mm}$ while that of the mast would be 4.7 mm, i.e. the mast would appear to be 2.4 mm too long. The error can be reduced by carrying out the measurement in the shade when, for most practical purposes, the effect of temperature can be ignored.

Proper Tension

Most precision steel measuring tapes are calibrated at a temperature of 20°C with a tension of 49.0 N (5kg) applied, and in the absence of a tension being stated on the tape these values should be used for accurate measurement. However, unless supported, the sag can also contribute, see below. Cloth or plastic tapes should not be used for boat measurement.

Sag in tape

Unless a flexible tape is laid along a straight surface it will always have some sag in it and this will cause an error, however small. The amount of sag and hence the error, depends on the tension T applied and the mass per unit length λ of the tape or cord.

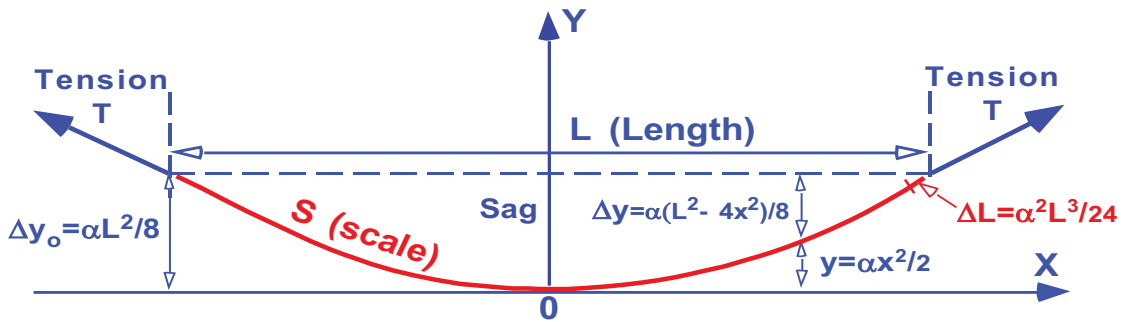

Figure F.4.2 The sag Δy and extra length ΔL of a flexible line or tape can be very closely approximated by a parabolic form.

The form of a flexible hanging tape or line suspended at two points which are at the same height is a catenary, with y the height above the centre:

$$y = \frac{\alpha}{2} (e^{\alpha x} + e^{-\alpha x} - 2) \approx \frac{\alpha x^2}{2} \quad \text{so at } x = 0 \quad \Delta y_0 \approx \frac{\alpha L^2}{8} = \frac{\lambda g L^2}{8T}$$

Where x is the distance from the centre of the tape, i.e. the ends are at $+L/2$ and $-L/2$, $\alpha = \lambda \cdot g/T$, λ is the mass per unit length of the tape in kg/m and T the tension in Newtons.

Then the length S along the tape and the difference $\Delta L = S - L$, when the ends are a horizontal distance L apart are:

$$S = \frac{2}{\alpha} \sinh\left(\frac{\alpha L}{2}\right) \approx L + \frac{\alpha^2 L^3}{24} \quad \text{so} \quad \Delta L \approx \frac{\alpha^2 L^3}{24} = \frac{\lambda^2 g^2 L^3}{24T^2}$$

For measurement the value of α is generally less than 0.02, in which case the deviation of the catenary from a parabola is less than 0.2 mm over a 10 m span, so is negligible.

Example: 470 LOA and keel rocker

Steel tape (10 mm x 0.17 mm)

$\lambda = 13.3 \text{ g/m} = 0.0133 \text{ kg/m}$

Tension $T = 49.0 \text{ N}$, i.e. weight of 5 kg m^{-1}

Then $\alpha = \lambda \cdot g / T = 0.0133 \times 9.81 / 49 = 0.00266$

For a 470 the error in LOA is $\Delta L = (L^3 \cdot \alpha^2) / 24 = (4.70^3 \times 0.00266^2 / 24) \text{ m} = 0.031 \text{ mm}$

The sag would be $\Delta y = (L^2 \cdot \alpha) / 8 = (4.70^2 \times 0.00266 / 8) \text{ m} = 7.33 \text{ mm}$

So for keel rocker measurement use a very light line, i.e. twine (or, for boats more than 7 m, another way of measurement like a laser beam or a surveyor's level) as the sag is proportional to λ , the square of the length L and inversely to the tension T .

For mast deflection measurements, where the ends of the line move as the mast bends it is useful to use a somewhat elastic line so the tension remains essentially constant.

Parallax Error

This is a misreading of a scale which is not contiguous with the object being measured when the line of sight is not perpendicular to the scale. Parallax errors can be eliminated by placing the scale adjacent to the object being measured.

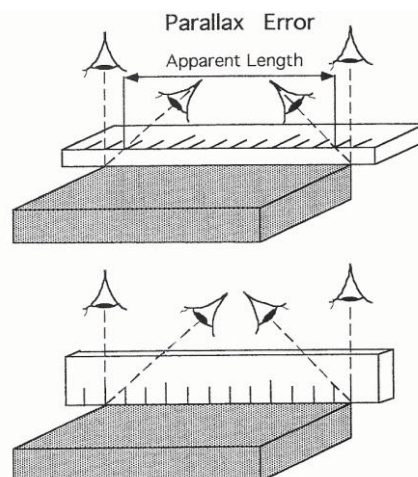
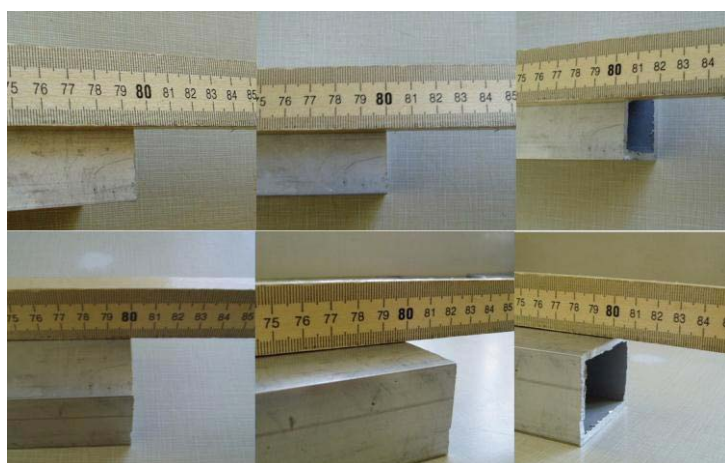

Figure F.4.3 *The parallax error when sighting a non-contiguous scale*

Sine and Cosine errors

Example: Frame measurement of chine.

In general do not sight down or use a plumb line to transfer the measurement point perpendicular to the measurement, as this involves a sine error $\Delta = (L_s - L)$, i.e. an error proportional to the sine of the angular error.

It is much better, if possible to measure directly in the direction of the dimension, i.e. L_c . For the same angular error $\Delta = (L_c - L)$ which is proportional to the cosine of the angular error, and much smaller than the sine error.

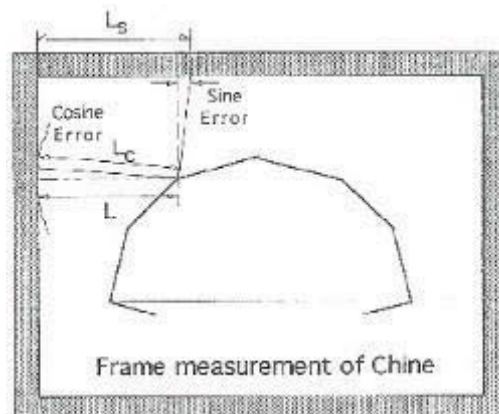

Figure F.4.4 Sine and Cosine errors

Measurement Axes errors

Unless specifically required by class rules to be taken in another way, all measurements denoted by words such as 'above', 'below' or 'forward' in relation to parts or items, are taken parallel to or at right angles to one of the three major axes of the hull, which are defined in the ERS section C.6.3 as:

MAJOR AXES

The three major axes of the boat at 90° to each other – vertical, longitudinal and transverse – shall be related to the baseline and the hull centerplane.

The baseline is as defined in the **class rules**, and although typically parallel to the DWL, this is not always the case. The Europe class defines how the hull is to be levelled, see figure F.4.5, and although small deviations from the correct level will cause negligible errors for measurements of short distances, the error can become appreciable when taking a long measurement such as the length of the hull.

If for instance the Europe LOA is measured parallel to the deck (as for the FD) this measurement differs from the design LOA by an error proportional to Cosine of the misalignment angle θ .

Europe Dinghy LOA = 3350 ± 6 mm
 Sheerline angle = $\text{Atan}(180/3350) = 3.08$ degrees
 Length along deck = $3350/\text{Cos}(3.08) = 3355$ mm
 Difference $\Delta = 4.8$ mm (0.144 %)

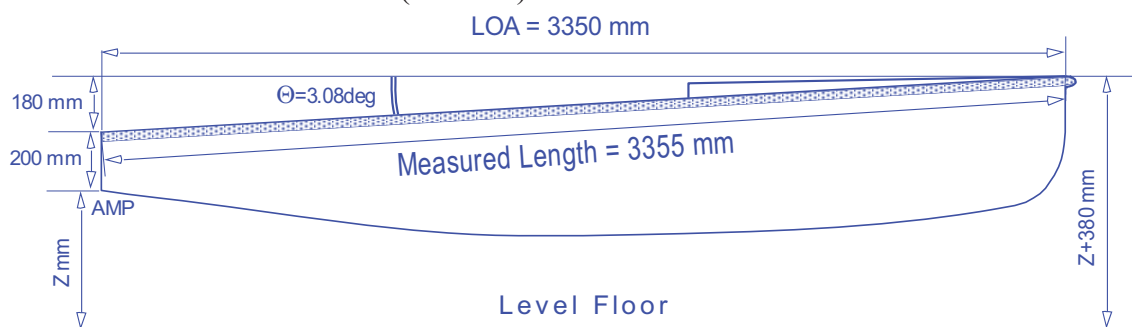

Figure F.4.5 The error due to incorrectly measuring the LOA of a Europe dinghy parallel to the deck is proportional to the Cosine of the angle θ .

Wedge gauges

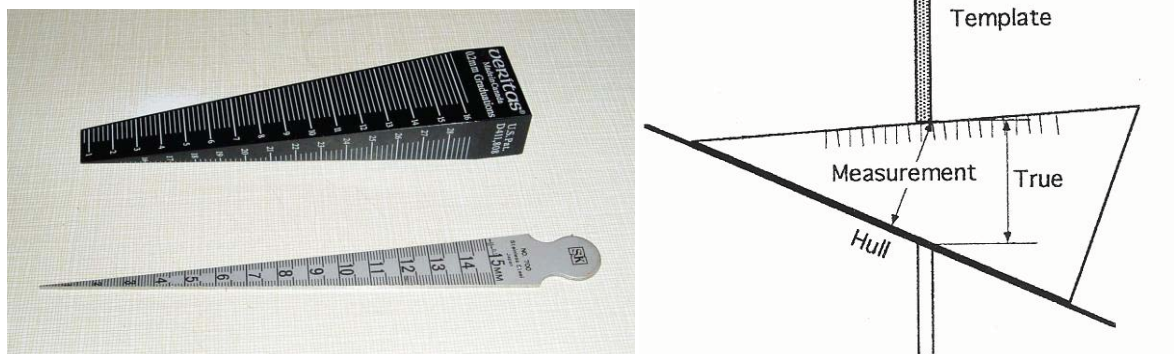

Figure F.4.6 Two types of wedge gauge and the error in gap measurement.

Wedge gauges come in two varieties:

- (a) Those that measure perpendicular to one edge, and
- (b) Those that are intended to measure inside diameters and measure perpendicular to the bisector of the gauge angle.

Most sailboat classes intend the template gap to be measured in the plane of the template, and perpendicular to the template edge. A wedge does not measure this correctly if the section is angled as shown in figure F.4.6. This again is a Cosine error and so unimportant where the template is almost perpendicular to the hull surface, but does become important at the bow sections where the angle is significant. The Yngling class rules state that the gap shall be measured “perpendicular to the hull” so in this case the wedge gives the required gap measurement.

Random errors

Random errors are due to fluctuations leading to results which are randomly different from measurement to measurement. They are:

- (a) The sum of uncontrollable small variations in many factors, and so they are statistical in nature.
- (b) Present to some degree in all measurements.
- (c) Cause repeated measurements to vary randomly.
- (d) Positive or negative.
- (e) The distribution of the data generally follows a Gaussian probability distribution.
- (f) Can be reduced by more precise instruments, better procedure and by averaging.
- (g) A quantitative estimate, the standard deviation σ , can be derived from the scatter of a set of measurements.
- (h) Random errors add in quadrature, $\sigma^2 = \Sigma \sigma_i^2$
- (i) Random errors limit the precision of the measurement.

Example:

The plot shown in figure F.4.7 is a histogram of 400 readings of the time a dropped coin took to reach the floor, as manually measured using a stop watch.

The variability in manually starting and stopping of the timer produces a random error such that there is a 63 % chance that the next reading will be within $\sigma = \pm 0.06$ s of the 0.56 s mean.

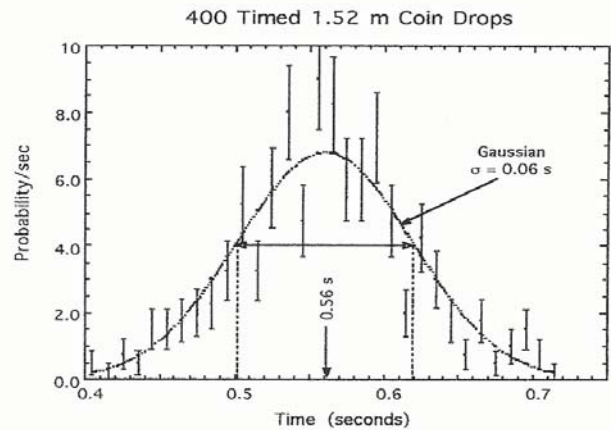

Figure F.4.7 Histogram of 400 time intervals

However, the standard deviation of the mean is $\sigma_m = \pm 0.06/\sqrt{400} = \pm 0.003$ s i.e. there is a 63 % chance that the mean of the next 400 readings will be within ± 0.003 s of this mean. One would expect the precision of a hand timed Lamboley period to be similar, so the standard deviation of the mean of 5 readings would be $\sigma_m = \pm 0.06/\sqrt{5} = \pm 0.027$ s.

It will be seen that taking many readings does reduce the random error of the mean. However, it is much better to improve the technique, i.e. for a Lamboley test to use a photogate, $\sigma = \pm 0.0005$ s, to start and stop the timer.

Resolution

Resolution is the degree to which a measured value is 'rounded off' by the instrument. For example a length of 100.74 mm would be recorded as 101 mm when using a ruler graduated in mm. Electronic instruments display the measurement to a given number of significant figures, thus rounding off the result. A display of 101 means that the measurement is between 100.501 and 101.499. It should be pointed out that some instruments round off to 0 or 5 for the last digit and thus have a resolution five times worse than may appear. Thus the degree of resolution contributes to the error in a measurement. In order for the instrument resolution not to increase the error it should be chosen to be greater than the intended precision of the measurement.

Length:

Finite size of scale divisions limit the precision with which a measurement can be made.

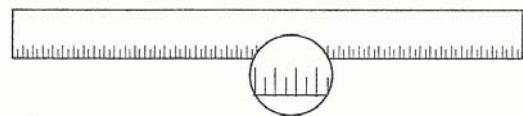

Figure F.4.8 Instrument resolution, Micrometer resolution 0.001 mm, stop watch resolution 0.01s and scale resolution 0.05 kg

Time:

Stop watches are typically limited to 1/100 sec and this is more than adequate for hand operation.

Table F.4.3 Precision, Resolution and Accuracy

Range	Handling Error	Resolution	Accuracy	Instrument
Length measurement:				
1 to 10m	±2.6 mm@5m	1 mm	±1.3 mm@5m	measuring tape, Class II
1 to 2000 mm	±2.8 mm	1 mm		Meter stick, not classified
1 to 300 mm	±0.5 mm	0.5 mm	±0.5 mm	Steel rule, not classified
1 mm to 300 mm	±0.01 mm	0.01 mm	±0.03 mm	Digital calliper
20 microns to 25 mm	±0.001 mm	0.001 mm	±0.002 mm	Digital micrometer
Time period measurement:				
Greater than 10 s	± 0.1 s	0.01 s	± 0.01 s	manual stop watch
Less than 10 s	± 0.1 ms	0.1 ms	± 0.1 ms	photocell and timer

Weight:

For precision weighing digital scales should be certified for legal trade and have a resolution of at least 1:2000

Table F.4.4 Scale Span and Resolution

Span	Resolution		Use
0 to 2.000 kg	1 g	1:2000	Corrector weights
0 to 20.00 kg	10 g	1:2000	Rudders, masts, foils
0 to 250.0 kg	0.1 kg	1:2500	Dinghy hulls
0 to 1000 kg	0.5 kg	1:2000	Keelboat hulls

Resolution and significant figures in Class Rules

The purpose of the measurement process in the wider context of boat measurement is to determine whether or not certain critical values conform to stipulated minima, maxima or limits. The certainty of an accurate measurement is of interest to the measurer who signs the measurement form to say the boat conforms to the rules and also to the owner, who may find his boat is the subject of a measurement protest at a later time. There are several ways in which resolution, systematic and random error impinge on the measurement process and which contribute to the degree of certainty that boat is class legal.

The degree of resolution used to define maximum and minimum values stipulated in class rules may also contribute to the uncertainty issue. A hull weight limited by the class rules to a value of more than 130 kg might be measured with a resolution of 1 kg. Then a hull of 129.51 kg would be read as 130 kg, i.e. legal while if a scale with 0.1 kg resolution had been used it would read as 129.5 kg and the hull would be illegal, or should it be accepted because, when expressed to the same degree of resolution as the value in the class rules, it becomes 130 kg? If that is not acceptable, then should a weight of 129.51 kg be accepted because, measured to the commonly available degree of resolution, it becomes 130.0 kg?

The choice of suitable units of measurement and degree of resolution should be considered when the class rules are formalised, so that critical measurements are

invariably repeatable at initial and control measurement. A measurement is only complete if it is accompanied by a statement of the uncertainty in the measurement but this uncertainty is a bit out of reach of a measurer in the sailing world. In the scientific community the number of significant figures indicate the precision of the measurement, as ± 0.5 in the least significant figure quoted. This can be extended to specifying the precision required by a rule. Currently class rules are understood to be absolute limiting values, i.e. a maximum value of 20 units means the ABSOLUTE MAXIMUM VALUE is 20 units precisely.

The effect of precision

Currently the definition of a class rule measurement implies a sharp boundary between the legal and the illegal values. In principle if a 645 kg hull is 1 g under the minimum weight it is not class legal, in practice however it would be extremely difficult to measure with this precision, as measured values always have some uncertainty due to random errors. When the measurement is either well inside or well outside the boundary the uncertainty is not a problem, i.e. one can even eyeball the measurement for a rough value. For regatta inspection, obviously legal items can just be inspected. If there is doubt a quick measurement may settle the question, however if there is still doubt, then a careful more precise and time consuming measurement has to be made.

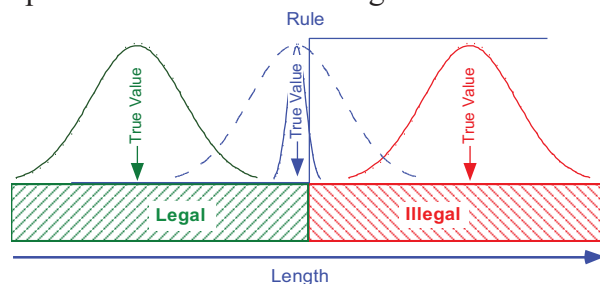

Figure F.4.9 Low precision measurements are acceptable when the value is far from the limit (red and green), but higher precision is required when close to the limit (blue)

The figure F.4.9 illustrates a length measurement, which is initially made quickly with a tape measure, so the precision, as represented by the wide distributions that many of such measurements would produce, is however definitive if the value is either bigger or smaller than the legal limit by more than twice the width of the distribution. However, if the value is close to the limit, the random errors could lead to measurements on either side of the limit, and so are not precise enough to decide the issue. The precision can be improved by tensioning the tape, using the 100 mm graduation at one end, not the zero, and having an assistant ensure that it is on the mark, making sure the tape is not kinked etc., then the distribution would be narrower, as shown, and can more reliably be used to show the component is legal, for this case.

Problems due to imprecision

An example is the uncertainty in a gyradius measurement:

A hull which is quite illegal is measured and found to be only just illegal because the first measurement happens to overestimate the true value, i.e. the random error is positive. The hull is illegal, but because of the random errors there is even a 20% chance of finding it legal.

The competitor then adds lead at the bow as instructed, and makes sure by adding a little extra! The hull is now legal but there is a 40% chance of finding it illegal, i.e. the random errors could now be negative.

The hull is re-measured and found to be more illegal than before (?), because now unfortunately, the random error is large and negative.

The competitor then adds even more lead at the bow as instructed, and now, because the random error is positive, the measurement is larger than the now more than legal true value, so the measurement indicates a huge gyradius (!) ... The competitor now wants to remove lead And concludes that the measurer is incompetent!!!

The problem is that sailors demand to be closer to the limit than the precision of the measurement can determine.

Figure F.4.10 Radius of gyration precision.

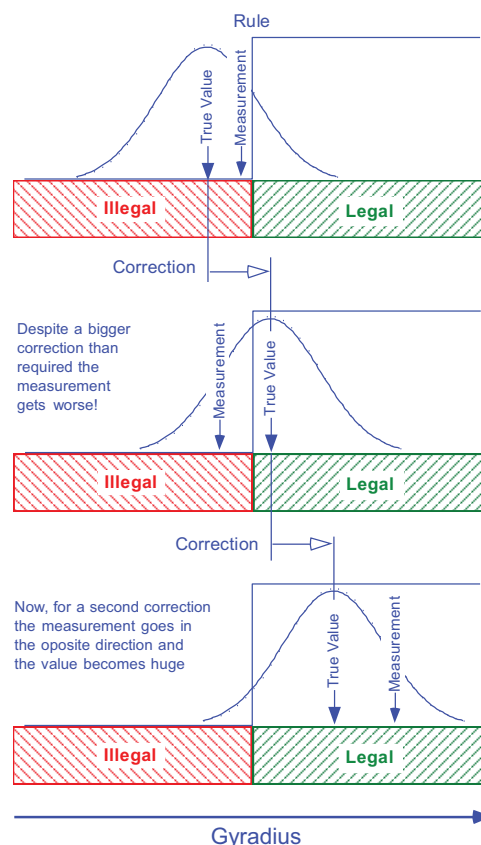

Combination of errors

In general one should always try and measure a quantity directly and not as a combination of a number of measurements, primarily because the errors compound.

- (a) Systematic errors Δ add algebraically, $\Delta = \Sigma \cdot \Delta_i$.
- (b) For addition and subtraction random errors add in quadrature, $\sigma^2 = \Sigma \sigma_i^2$.
- (c) When multiplying or dividing fractional random errors (percentages) add.

During measurement one obviously tries to minimize errors so it is primarily when one is choosing between two alternative techniques, or recommending the formulation of a class rule, that one needs to understand how the errors affect the precision of the final measurement.

Examples:

1) Suppose you wish to estimate the weight of the hull-deck of a keelboat by subtracting the keel weight of 310 ± 3.5 kg ($\pm 1.1\%$) from the weight of 930 ± 4 kg ($\pm 0.48\%$) of the boat on its trailer. If the trailer is found to be 300 ± 3 kg ($\pm 1.0\%$), the hull-deck is then 320 kg. However, if the span calibration of the scale used for the measurements was 1 per cent high (a systematic error) the correct values would be 306.9 kg, 920.7 kg and 297.0 kg giving a hull-deck of 316.8 kg i.e. 1 per cent different from the measured value. Note all corrected values are 1 per cent low, and that after the scale's calibration is known the result can be corrected.

However, because you do not know which of many keels was put on this hull and the scatter of the keel weights was ± 3.5 kg, and because the hull and trailer had all sorts of fittings and wet lines, you could only estimate the weights to within ± 4 kg and ± 3 kg

respectively. The uncertainty in the Deck-hull is $\pm\sqrt{(3.5^2 + 4^2 + 3^2)} = \pm 6.1$ kg, so the result is 316.8 ± 6.1 kg, and in this case, with an uncertainty of ± 6 kg, the 0.8 kg is really unknown. Although, in order to avoid round off errors it is useful to carry the 0.8 in any further calculations, the result should only be quoted to three significant figures, namely 317 ± 6 kg. Note the uncertainty (random error) in the result is $\pm 1.9\%$, i.e. higher than in any of the individual measurements.

2) You measure the diameter of a circular sail window as 600 ± 6 mm and calculate the area using a rounded off value of $\pi = 3.1$ to get $\text{Area} = [3.1 \times (600/2)^2] \times 10^{-6} = 0.279 \text{ m}^2$. You have made a systematic error by rounding off π to two figures. The correct value is $[3.14159 \times (600/2)^2] \times 10^{-6} = 0.283 \text{ m}^2$, i.e. 1.3 per cent higher. If you calculate the area of many windows with $\pi = 3.1$ they are all 1.3 per cent low, and can subsequently be corrected for this systematic error.

However the uncertainty in the diameter is ± 1 per cent so the uncertainty in the radius is ± 1 per cent, but because the radius is multiplied by itself the fractional error has to be doubled, so the uncertainty in the area is ± 2 per cent, then the $\text{Area} = 0.283 \pm 0.006 \text{ m}^2$. Given this precision the result can be quoted to three significant figures and a value of π to at least three significant figures should be used in the calculation. Note that dividing by 2 and multiplying by π use exact numbers, if not rounded off, so do not involve any additional random errors.

3) A Finn dinghy is found to have only one connected buoyancy tank and you require him to install an air bag. You measure the approximately cylindrical bag to have a circumference of $3.02 \pm 0.05 \text{ M}$ ($\pm 1.7\%$) a length of $1.10 \pm 0.03 \text{ M}$ ($\pm 2.7\%$) and a weight of $2.2 \pm 0.1 \text{ kg}$ ($\pm 4.5\%$) and want to calculate the buoyancy $F_b = [\rho V - W = 1.0 \times 10^3 \times 1.10 \times 3.02^2 / 4\pi - 2.2] \times 9.81 = 796.1 \text{ kg} \times 9.81 = 7810 \text{ N}$. If, however, you are sailing on sea water the density is $\rho = 1.025 \times 10^3 \text{ kg/M}^3$, i.e. 2.5 per cent higher, so the buoyancy is 8005 N , a systematic error of 195 N .

The fractional uncertainty in the volume V is $\pm\sqrt{[(0.03/1.1)^2 + 2(0.05/3.02)^2]} = \pm 0.036$ and, for only systematic error in the density, the random error in ρV is $\pm 0.036\rho V = \pm 28.7 \text{ kg}$. The uncertainty in the net buoyancy is then $\sqrt{[28.7^2 + 0.1^2]} = 28.7 \text{ kg}$ (3.6%), i.e. the uncertainty in the weight of the bag is relatively so small as to have a negligible effect.

4) The Lamboley test is a measurement which involves significant manipulation of the measured quantities in order to obtain the result. Two periods of oscillation are measured and a length, the radius of gyration, is calculated. This calculation involved the difference between the squares of the measured periods, so the errors are significantly amplified, both by squaring and by taking the difference between the two squares. Most lengths of the order of a meter can be measured to within $\pm 1 \text{ mm}$, so most sailors are surprised that even with careful period averaging the uncertainties in a radius of gyration measurement can be as much as $\pm 10 \text{ mm}$, to say nothing of the systematic errors if the amplitude is not specified.

F.5 Measurement Techniques and Reproducibility

Technique:

- When possible, do not measure a quantity as the difference between two values, e.g. skin thickness, large tare weight, etc.
- The use of two scales (or tongue weight) is to be discouraged, except when the scale is a multi-pad scale specifically designed for this, see figure F.7.9.

Templates:

Precision templates are often used in order to increase the precision and reproducibility of measurement checks during regatta inspection.

- Aluminium hull templates.
- Mylar master to check templates.
- Rudder and centreboard templates.
- Gunwale, rubbing strake gauges.
- Gauges for masts, booms and spinnaker poles.
- Mylar templates for sails.

Records:

Accurate and complete records are essential during measurement and it is often beneficial to have a record keeper keep them while you measure. This facilitates

- Comparison with measurement certificate.
- Record keeping on paper as backup, as well as on a computer.
- Records should be available to measurers on the Internet.

Calibration:

The calibration of all tools should ideally be checked before any important regatta.

- For sailboat measurement SI units and standards are used.
- For the precision required for sailboat measurement the calibration of steel tapes, callipers, etc. are generally not a problem.
- Quartz timing devices generally do not need recalibration, but older computers often do.
- Mechanical watches should deviate by less than 1 second a day (0.001 %). This can be checked against the NIST time standard at <http://www.time.gov/>.
- Calibration of weighing scales should, if possible be checked on site against calibration standards of similar mass to the object to be weighed.

F.6 Tool certification: Accuracy & Standards

Not all tools are certified: the following requirements apply to certified tools.

Certification error:

This is the error permitted when the tool is certified. This error is the permitted maximum figure for positive or negative deviation from the correct value. The value of the Standard (Normal) or the Standard Measurement Installation is considered to be the correct value.

Handling error:

If the error exceeds this value, then the tool must be recertified. Normally it is twice the certification error.

Correctness of results:

Tools must be built so that when used for the intended purpose and within the intended measurement conditions, correct results may be expected to within the certified precision of the instrument.

F.6.1 Mechanical tools for length measurements

The **certification error** is for:

Measuring tapes	1.0 mm
Callipers, measurement capacity up to 500 mm	0.1 mm
Callipers, measurement capacity greater than 500 mm	0.2 mm
Micrometre, measurement capacity up to 100 mm	0.01 mm
Micrometre, measurement capacity greater than 100 mm	0.02 mm
Indicator, up to a length of 10 mm	0.02 mm

Callipers or Micrometres are classified by DIN 3650

Another standard, common as company classification is: $\text{Error} = (1 + L \text{ (mm)} / 50) \mu\text{M}$.

F.6.2 Electronic tools for length measurements

Normally the reading shows better results than the granted accuracy. Users must check carefully what is written about it in the manual. Certified electronic tools are rare and expensive. Uncertified Electronic measurement tapes with resolution 1 mm are now commercially available.

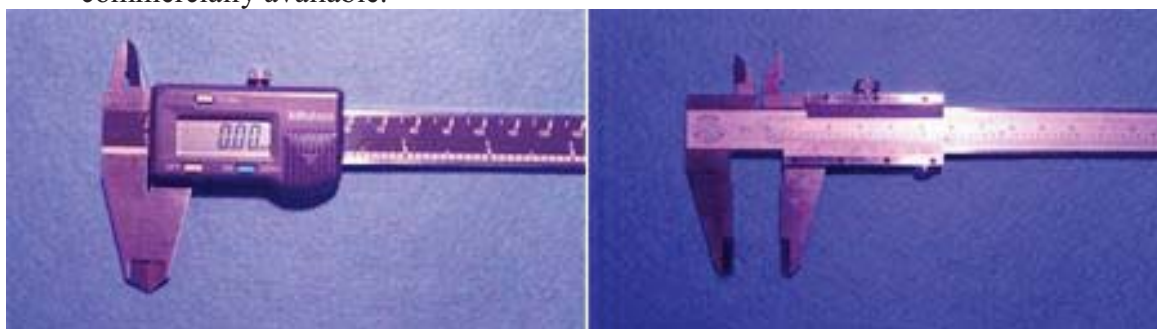

Figure F.6.2.1 An electronic calliper with resolution 0.01 mm and a Vernier calliper which can be read to 0.05 mm.

Laser triangulation sensors provide high precision distance measurements with typical performance listed below

Table F.6.2.1 Laser triangulation sensors

Measuring range mm	Resolution μm
20-25	0.6
20-30	1
30-50	2
45-95	5
50-150	10
60-260	13
100-350	32
200-800	80



Figure F.6.2.2 A laser triangulation sensor

F.6.3 Straight Edges

An alloy or steel profile (approx. 40/60 mm) normally is straight, within an unknown amount, but at least it is stiff enough to work with and can be checked by bending and light reflections or with a laser beam.

Precision Straight Edges are classified by DIN 874.

When supported at the “Bessel” points, i.e. at 0.22 of the whole length from each end, the certification tolerance is (mm):

Table F.6.3.1 Straight Edge Certification tolerance

Length of edge	100mm	500 mm	1000 mm	1500 mm	2000 mm	3000 mm
DIN 874 / 00	0.002	0.004				
DIN 874 / 0		0.007	0.012	0.017	0.022	0.032
DIN 874 / 1		0.012	0.021	0.029	0.037	0.054
DIN 874 / 2		0.021	0.033	0.046	0.058	0.083

F.6.4 Square Edges

They are classified by DIN 875 and the certified angle tolerance is (mm):

Table F.6.4.1 Square Edge Certification tolerance

Length of angles	150/100	200/130	300/200	500/330	750/375	1000/500
DIN 875 / 00	0.004	0.004				
DIN 875 / 0	0.008	0.009				
DIN 875 / 1	0.018	0.020	0.025	0.035		
DIN 875 / 2	0.035	0.040	0.050	0.070	0.085	0.120

F.6.5 Spirit and Electronic Levels

For uncertified spirit levels the error is approximately 1 mm/m and precision levels go up to 0.1 mm/m.

They are classified by DIN 877.

DIN 877 / Class 1a → 0.02 mm/m

DIN 877 / Class 1b → 0.1 mm/m

DIN 877 / Class 2 → 0.4 mm/m



Figure F.6.5.1 A laser level, a 0.1 mm/m precision level, a hanging, a centre and a keychain level.

A wide range of electronic inclinometers, plumb bobs and levels are now available, and implemented in smart phones such as the Apple iPhone 4, which also has a MEMS gyro and accelerometer.



Figure F.6.5.2 A 0.05 deg. resolution inclinometer and the iPhone 0.1 deg. resolution level.

Water tube level

Measurement of boats on uneven or sloping ground requires a means of levelling the baseline. Although a surveyor's level can be used, a cheap and simple alternative is a flexible tube, with a transparent tube at each end, and filled with water with some detergent added. It is essential that the tube not have any “air locks” in it, so filling must be done carefully. The internal diameter of the tubes should be at least 8 mm. The smaller the transparent tubes the more rounded the meniscus at the water surface, which is our reference plane, and the more difficult it gets to take accurate readings. The detergent reduces the meniscus. The length of the tube required of course depends on the length of the boat to be measured. About six metres is required for a boat 4.70 metre in length, but with an appropriate length tube this system can be used for boats of any length.

The advantage of this system is that the transparent tubes, which need not be vertical, can be brought very close to the reference marks on the hull and easily be read to within ± 1 mm. Thus a 470 hull can be levelled to within ± 0.12 degrees. This system using mercury and micrometers to read the surface is used to level the mile long Linear Accelerator at Stanford University.

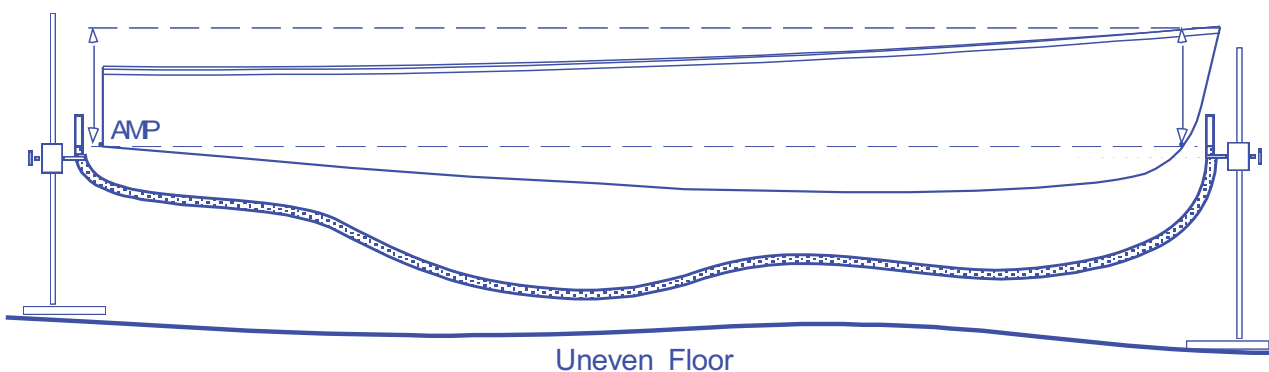

Figure F.6.5.3 A water tube for precisely levelling a hull on which baseline reference points have been established according to the class rules.

F.7 Mass and Weight

The amount of matter an object contains is its mass “**m**”. The mass of an object determines its inertia, that is, how difficult it is to get it to change its motion. Newton’s second law is $\mathbf{F} = \mathbf{ma}$, or if a given force \mathbf{F} is applied to the object then the bigger the mass \mathbf{m} the smaller the acceleration \mathbf{a} that results. The weight $\mathbf{W} = \mathbf{mg}$ of an object is the

attractive force \mathbf{W} that the earth exerts on the object and is proportional to the mass \mathbf{m} . The proportionality constant “ \mathbf{g} ” is the weight force per unit mass, in Newtons per kg, and varies with location.

Weighing an object actually measures the upward force \mathbf{N} exerted by the scale on the object which is required to balance the downward weight force \mathbf{W} . This upward force only equals the weight if the object is not accelerating and if these are the only two vertical forces acting.

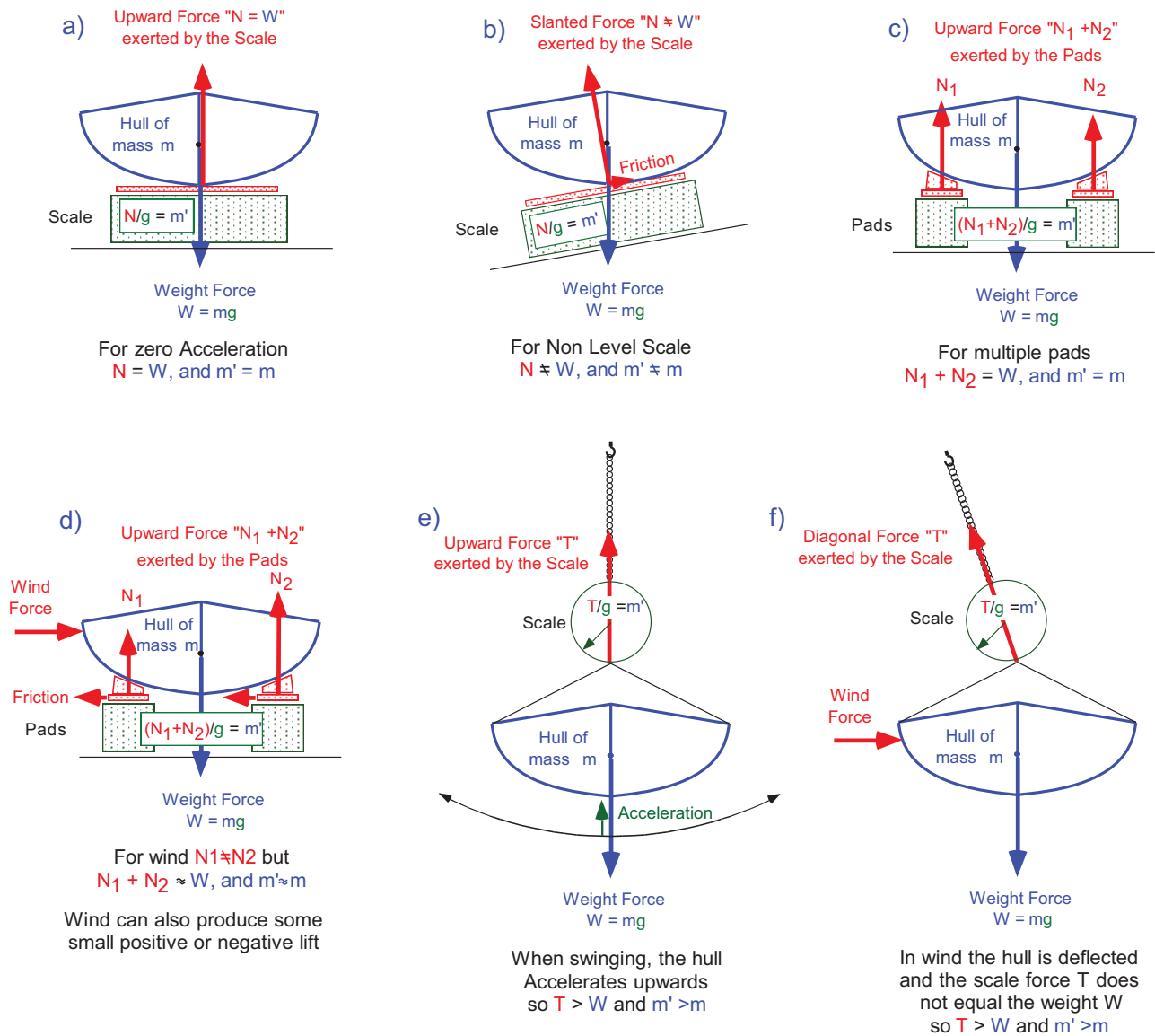

Figure F.7.1 The physics of weighing: The scale measures the force $N = m \cdot g$ it exerts to counteract the weight $W = mg$ and assumes a value of g to convert this force to a mass reading $m' = N/g$. Note a wind can also produce some lift which will affect the measured weight

The act of weighing measures the force \mathbf{N} the scale exerts to balance the force of gravity on the object, however, scales are calibrated to read “the mass \mathbf{m}' on which the gravitational force would be the same as that measured” rather than the force \mathbf{N} which is actually measured, and therein lies the problem. That is, the scale manufacturer builds in the equation $\mathbf{m}' = \mathbf{N}/\mathbf{g}$, and assumes a local value of “ \mathbf{g} ”. Thus when a scale is moved (from one latitude to another, so “ \mathbf{g} ” changes) the scale calibration is no longer valid. For accurate weighing the scales must be calibrated (span adjusted) in the location in which

they are to be used. If however, this is not possible then a correction to the scale reading can be made as the variation of g with latitude and height above sea level is well known.

To take care of this modern scale calibration equipment allows the latitude for which the scale is to be calibrated to be entered into the program. The variation with longitude is only small. The major variation of the effective gravitational force per unit mass g' is due to the rotation of the earth which caused an equatorial bulge and hence a variation of the radius R with latitude, and the centrifugal force $\omega^2 R \cos \phi$ in the rotating system of the earth. These combine, as shown in figures F.7.2 & F.7.3 to give the effective gravitational force per unit mass g' at sea level as:

$$g' = 9.78049(1 + 0.0052884 \sin^2 \phi - 0.0000059 \sin^2 2\phi)$$

While the variation with height is

$$g'_h = g' - (0.30885 + 0.00022 \cos 2\phi - 0.000072h)h$$

Where g' is given above and h is in km. These equations can be used to estimate the change in scale calibration to within the resolution of a 1:5000 scale.

The earth's gravitational field is now routinely measured to much better precision than this by the GRACE satellites, as shown in figure F.7.4. Assuming that a scale has been calibrated at the ISAF office in Southampton then the corrections for a number of sailing venues are listed in table F.7.1.

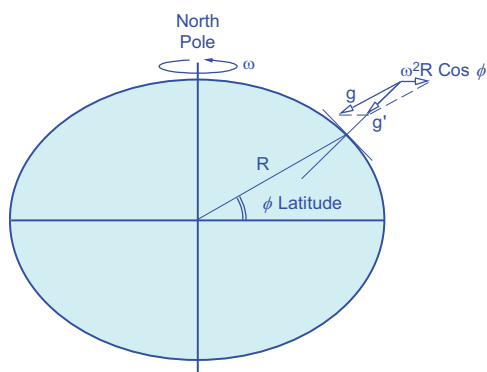

Figure F.7.2 The Earth's figure (equatorial bulge exaggerated) showing the variation of the gravitational force per unit mass, g' , with latitude ϕ , due to the varying radius R and the centrifugal force $\omega^2 R \cos \phi$.

Figure F.7.3 The variation of the effective gravitational force per unit mass with latitude.

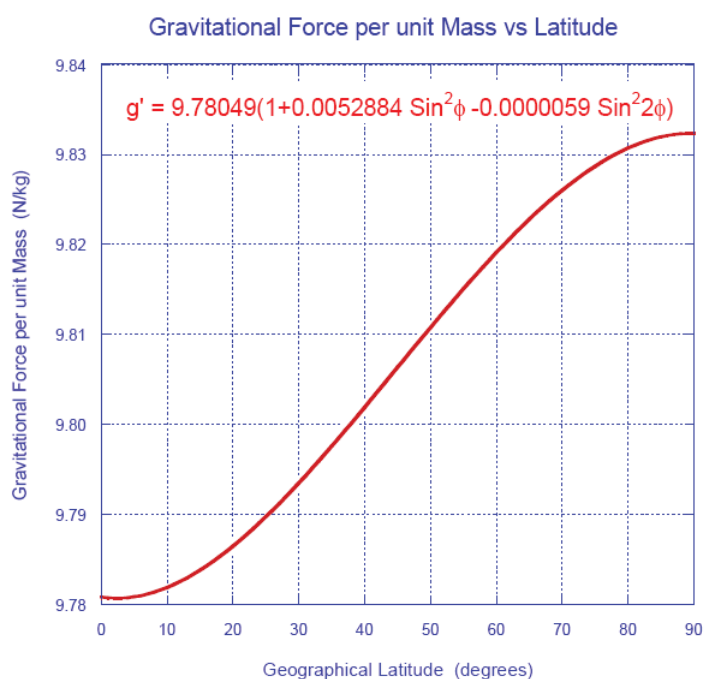

Table F.7.1 Variation of the gravitational force per unit mass with latitude

Place	Latitude Degrees	Gravity N/kg	Correction g/kg	Place	Latitude Degrees	Gravity N/kg	Correction g/kg
North Pole	90.000	9.832	-2.09	San Francisco	37.872	9.800	1.20
Helsinki	60.170	9.819	-0.79	Qingdao	36.095	9.798	1.35
Malmö	55.722	9.816	-0.42	Long Beach	33.889	9.797	1.54
Kiel	54.378	9.815	-0.30	San Diego	32.806	9.796	1.63
Medemblik	52.789	9.813	-0.16	Miami	25.815	9.790	2.18
Southampton	50.992	9.812	0.00	Dubai	25.271	9.790	2.22
Vancouver	49.331	9.810	0.15	Acapulco	16.867	9.785	2.74
Trieste	45.654	9.807	0.49	Singapore	1.308	9.781	3.17
Halifax	45.086	9.806	0.54	Equator	0.000	9.780	3.18
Kingston	44.233	9.806	0.62	Rio de Janeiro	23.033	9.788	2.37
Hyerès	43.219	9.805	0.71	Sydney	33.935	9.797	1.54
Marblehead	42.510	9.804	0.78	Cape Town	33.961	9.797	1.54
Palma de Majorca	39.608	9.801	1.04	Melbourne	37.972	9.800	1.19
Annapolis	39.044	9.801	1.09	Wellington	41.345	9.803	0.88

The correction is that required for a scale calibrated in Southampton, UK, i.e. if used at the North Pole it reads 2.09 g high for each kg.

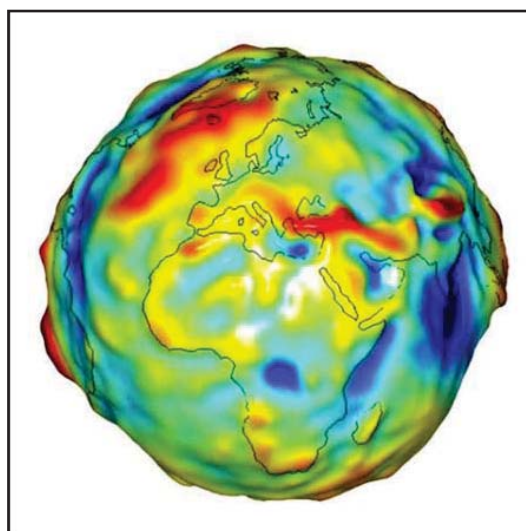

Figure F.7.4 *Grace Satellite map of the detailed variation of the Earth's gravity. Variations are in mm/s², so can be ignored when correcting scales with resolution of 1:5000.*

Buoyancy Correction

The above theory assumes that the weighing is in a vacuum and when weighing a hull in air there is a buoyancy force acting in the opposite direction to the weight, think of a helium balloon! For a hull of volume V and density ρ_H the weight $Mg = \rho_H Vg$ and the buoyancy force is equal to the weight of the displaced air $M_Ag = \rho_A Vg$. The measured weight M_M is then

$$M_M g = (M - M_A) g = M(1 - \rho_A / \rho_H) g$$

Determining the volume of the hull material and hence its average density is somewhat arbitrary and can be calculated from the densities of the construction materials, note however that most keelboats almost float when swamped (floating is required for some

keelboats) so have an average density near 1 gm/ml, thus the buoyancy correction to the weight, due to air of density about $\rho_A = 0.0012$ gm/ml, is of the order 1:1000. You may correctly argue that the scale is calibrated in air, but this is done with iron certified weights of density $\rho_C = 7.8$ gm/ml so the scale reading M_C for a calibration mass of M is:

$$M_C g = (M - M_A) g = M (1 - \rho_A / \rho_C) g$$

If the span is now adjusted ignoring buoyancy so that the scale reads the value of the calibration mass M , rather than M_C , the correction to the measured hull mass M_M is:

$$M_C = M_M \frac{(1 - \rho_A / \rho_C)}{(1 - \rho_A / \rho_H)} \approx M_C \{1 + \rho_A (1 / \rho_H - 1 / \rho_C)\}$$

$$\approx M_C \{1 + 0.0012 (1 / 1 - 1 / 7.8)\} \approx 1.0010 M_C$$

Note that the correction depends on the difference in density between the item and the calibration mass, so it is larger for dinghy hulls, but disappears for iron keels and becomes negative for lead keels. For a 1650 kg Dragon the correction would be about 1.7 kg, which is not negligible. However, it is assumed that most class rules imply “weight as determined by weighing in air” in which case this correction can be ignored.

F.7.1 Scales

Cheap scales labelled “not legal for trade” are attractive but not recommended for serious weighing as they are not verifiable. Scales for legal trade are verified, i.e. the scale quality is high enough, have corner error less than one display step, and are reliable and precise enough for our job.

Scale Calibration

Calibration is the comparison between the output of a scale or balance against a set of standard weights. Calibration technically means to determine the difference between the scale readout and the standard weight. Adjustment of the zero and span means to bring a balance/scale into the state of accuracy required for its use. Therefore, 'calibration,' can mean adjustment, or establishing a set of correction data or a calibration curve.

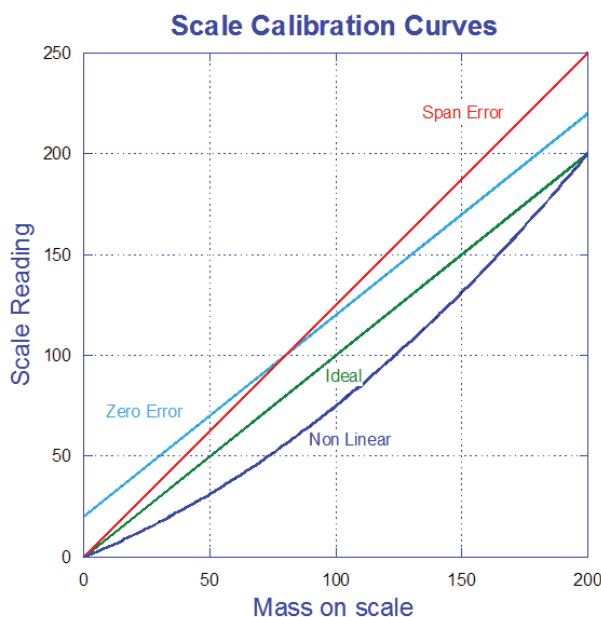

Figure F.7.1.1 Scale calibration curves.

The various types of error are illustrated by the Scale calibration curves of figure F.7.1.1. Zero and span adjustments will adjust the light blue and red curves to the ideal, but a linearity calibration is required to correct the dark blue curve. Linearity refers to the quality of delivering identical sensitivity throughout the weighing capacity of a scale.

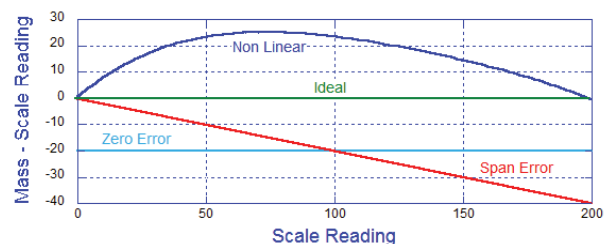

Figure F. 7.1.2 Scale correction curve.

The scale nonlinearity can be checked by weighing two objects each of approximately 40 per cent of the scale span first separately and then together. The sum of the two individual readings should equal the reading obtained when both objects are weighed together.

In order to more easily read a calibration curve it is usually plotted as the difference between the mass on the scale and the scale reading, as shown in figure F.7.1.2.

It is good practice to check the calibration on site with a mass close to that to be weighed and record the deviation.

Scale properties

There are a number of problems with weighing scales that a measurer should be aware of and check.

- Scales have a given accuracy, only if the scale is operated within temperature range stated by the manufacturer. This can be significant if the scale is operated outside, with some hulls weighed in hot sunny conditions at noon, while others are weighed in the cool evening. It is preferable to weigh indoors, or at least keep the scale in the shade.
- Although most electronic scales have stabilized power supplies it is nevertheless good practice to use fresh batteries or ensure that they are always fully charged.
- The ADCs used in scales are often nonlinear over the first and last 20% of the span so scales should preferably not be used over these ranges.
- Although choosing a scale with span 120% of the weight to be measured will give the best resolution this is not recommended as scales can be damaged by overloads. Shock loads can be significant and a scale with a span or overload rating twice the intended load is recommended. Great care should always be taken when loading a scale.
- Corner load and corner load error refer to the ability of a scale to deliver the same weight reading for a given object anywhere on the weighing pan or platform. This can be a problem with domestic platform scales.
- Drift or creep is a progressive (continuously upward or continuously downward) change in the number displayed on the digital readout. The weight readings do not stabilize. The main environmental factor affecting stability is temperature.
- Hysteresis is a property of load cells, and of other weighing systems dependent on elastic materials, such as spring balances, resulting in a different indication at the same load, depending upon the direction of approach to that load, i.e. whether it is approached by increasing the load or decreasing the load. It is most pronounced at the mid-point of the weighing range.

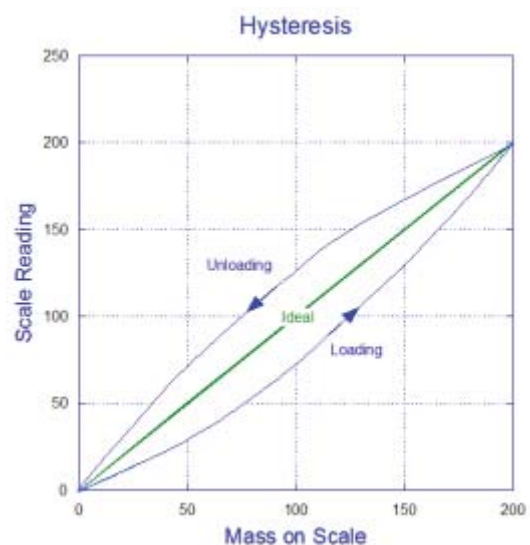

Figure F.7.1.3 Scale hysteresis

Precautions required when weighing are also described in the IRC manual.

Standard Calibration Weights

To achieve the required accuracy a scale should ideally be calibrated before use at a major regatta, and this is best done by qualified technicians and for the location in which the scale is to be used. A calibration certificate is only valid for the location where the calibration was performed. If you wish to calibrate the scale yourself you ideally need weights with a "certificate of accuracy", "calibration report" or "mass value certificate". Such standard weights are certified in different classes as listed in table F.7.1.1, and should be carefully stored if they are to maintain their accuracy.

Table F. 7.1.1 Standard weight certification error

Standard weight	Class F1 Fine weights	Class M1 Precision weights	Class M3 Commercial weights
1.0 g	±0,1 mg	±1 mg	±10 mg
100 g	±0,5 mg	±5 mg	±50 mg
1.000 kg	±5 mg	±50 mg	±500 mg
2.000 kg	±10 mg	±100 mg	±1.0 g
5.000 kg	±25 mg	±250 mg	±2.5 g
10.000 kg	±50 mg	±500 mg	±5.0 g
50.000 kg	±250 mg	±2.50 g	±25.0 g

Certified Scales

Certified scales have four classes of accuracy:

Table F. 7.1.2 Classification of Certified Scales

Class	Certification unit e	Min load	Number of certification units $n = \max / e$	
			Min unit	Max unit
I	$0.001 \text{ g} < e$	100 e	50000	
II	$0.001 \text{ g} < e < 0.05 \text{ g}$	20 e	100	100000
	$0,1 \text{ g} < e$	50 e	5000	100000
III	$0.1 \text{ g} < e < 2 \text{ g}$	20 e	100	10000
	$5 \text{ g} < e$	20 e	500	10000
IV	$5 \text{ g} < e$	10 e	100	1000

The requirements for scales are stated in the following documents:

1. OIML R76–1:1992. Non-automatic Weighing Instruments. Part 1: Metrological and technical requirements – Tests.
2. OIML R 111: 1994. Weights of Accuracy Classes E1, E2, F1, F3, M1, M2, M3.
3. Council Directive 90/384/EEC of June 20, 1990 (Harmonization of laws in member countries).

Class II, III and IV scales are used for official weighing.

Class II scales for precise weighing, class IV scales are for example truck boogie scales. Class III is sufficient for sailing. Problems disappear if class III scales that are verifiable for legal metrology are available. The display step value of these scales is 1/3000 or 1/6000 of the scales' measuring span. There are respective stickers on the scales.

Tolerances (limit of errors) & Certification error

Table F. 7.1.3 Tolerances and Certification error

Load				Limit of error
Class I	Class II	Class III	Class IV	
$0 < m < 50000 e$	$0 < m < 5000 e$	$0 < m < 500 e$	$0 < m < 50 e$	+/- 0.5 e
$50000 e < m < 200000 e$	$5000 e < m < 20000 e$	$500 e < m < 2000 e$	$50 e < m < 200 e$	+/- 1.0 e
$200000 e < m$	$20000 e < m < 100000 e$	$200 e < m < 10000 e$	$200 e < m < 1000 e$	+/- 1.5 e

The error in use is twice as big as the certification error.

Types of scale

Balance arm Scales

Balance arm Scales used in Doctor's offices or by butchers, although they maintain calibration independent of location and are very reliable, have been superseded by electronic scales. However, they have been used for crew weight.



Figure F.7.1.4 Balance arm scale

Spring scales

Spring scales can be adequate for many purposes and have the advantages of being light and of not requiring power. Their main disadvantage is that the reading can oscillate and has to be carefully read, which reduces the sailors confidence in the result. Typically for spring scales the divisions are 1:400 or less, thus their capacity should be matched to the anticipated load.



Figure F.7.1.5 Spring scales

Crane Scales

For keelboats, and other hulls too heavy to easily lift, a crane scale plus hoist is the most often used scale. Smaller hanging scales, often used by fishermen, can be used for masts, rudders and centreboards, but quality can be a problem.

Many crane scales now come with IR links to a hand control. The main disadvantage of a crane scale is that a gantry, crane or sufficiently strong structural beam from which it can be suspended is required. The lifting slings also have to be sufficiently strong, preferably legally certified, easy to attach, and their weight has to be tarred out.



Figure F.7.1.6 Crane scale

Dynamometers

Dynamometers are force measuring devices and as such reads in kN rather than kg, however they can be used for weighing and many of them automatically convert to reading mass. Alternatively the force reading can be converted using the local value of “g” thus avoiding re calibration when the dynamometer location is changed. The main advantage of a dynamometer is that they are very compact (fit in a briefcase and have minimal vertical extent) and rugged, which makes them ideal if they are to be transported by air.

Many of them come with a radio link thus allowing both control and reading on a handset. This is very convenient, and if required allows the weight to remain confidential. The data can also be stored and transferred to a computer. One caution is in order; the shackles supplied with the dynamometer are carefully sized, not only for strength, but are matched to the bearing in the dynamometer. If sufficient freedom of movement is not allowed, any torsion or twist when lifting will be directly transmitted into the dynamometer, leading to a potentially erroneous result.



Figure F.7.1.7 *A Dynamometer*

Platform scales

Platform scales are used for a variety of measurements, mast tip weight, corrector weights, crew weight and are more convenient than crane scales for dinghy hulls which can be easily manhandled onto the platform, thus avoiding the time to adjust the slings and hoist the hull.



Figure F.7.1.8 *A 34 x 0.01 kg, for mast weight, and a Platform scale for Dinghy hulls*

Multi Pad Scales

For large keelboats on cradles and catamarans a multi pad scale is more convenient than other types of scale. The pads are read in sequence and their sum displayed, thus some care has to be exercised that all the pads have the same calibration. The capacity of each pad should be enough that accidental excess loading does not damage them, but too great a capacity will reduce precision. It is inherent in a multi pad scale that it will not be as precise as a single load cell. If individual readouts are used then reading delays can lead to errors if, say due to wind, the data changes within the processing time.



Figure F.7.1.9 Tornado weighing using a 4-pad scale.



INTERNATIONAL MEASURERS' MANUAL

SECTION G

Measurement Tools

G Measurement Tools

G.1	Standard Measurement Tools	G 2
G.2	Purpose-designed measurement tools	G 5
G.3	Specialized tools	G 7
G.4	Special Equipment	G 8
G.5	Class-Specific Equipment	G 10

G.1 Standard Measurement Tools

The following items of equipment are needed for measuring most boats. Most classes use the metric system of measurement so equipment should be calibrated in metric, but some classes still use imperial units so dual calibration may be helpful.

Tape Measure

Must be of steel (preferably with offset zero), as fabric tapes can be very unreliable. 15 m and 5 m tapes are practical sizes for most classes, although for large yachts a longer tape measure is needed. Class II metric tapes are of an acceptable level for normal measurement.



Steel Ruler

One, either 150 mm or 300 mm long is usually sufficient. Articulated or folding rulers if not officially certified are not always accurate and are not recommended.



Straight edge

One straight edge about 2 m long is normally required. Steel or aluminium channel or angle is the most satisfactory. A shorter straight edge may also be required for some work. Some of them are combined with a spirit level, while laser straight line pointers have also become readily available and are quite useful for certain applications.

Spirit Levels

Preferably not less than 500 mm long, having both horizontal and vertical "bubbles". The sensitivity, and hence the accuracy, of some cheap spirit levels is not very great and these should be avoided. Electronic levels with digital readouts are available, but should be sensitive to at least 0.1 degree. Some spirit levels have an additional laser beam and can be used to make a baseline. For normal, uncertified spirit levels the error is approx. at 1 mm/m while better ones go up to 0.7 or 0.5 mm/m and classified ones up to 0.02 mm/m. To minimize the reading error always do the reading twice, turning the spirit level around 180 degrees. The reading of the clinometer sight varies depending on the light



conditions.

Plumb bob

A plumb bob and line may be required in order to establish a vertical line or to transfer a position to a point vertically below it. A heavy plumb bob with thin line is less likely to be affected by a slight movement of air when measuring in the open. The swing of the plumb bob may be dampened by suspending it in a bucket of water.



Set and/or Squares

Two tri-squares are normally required, an ordinary carpenter's square having arms not less than 150 mm long, and a larger one with arms about 600 mm long.

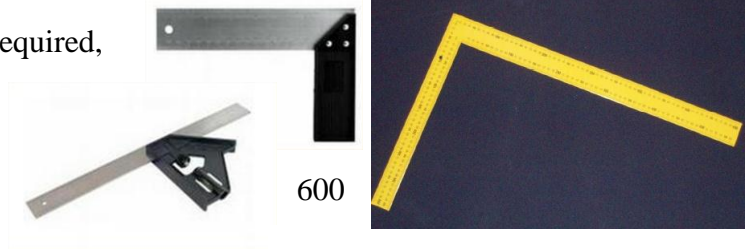

Laser squares are also available in various forms (2, 3 and 5 axis shown here).



Callipers

Vernier callipers are used for measuring items such as the diameters of wire, the thickness of small parts or the cross section of spars. Inside or outside compasses may help to transfer figures where you cannot reach with a calliper.

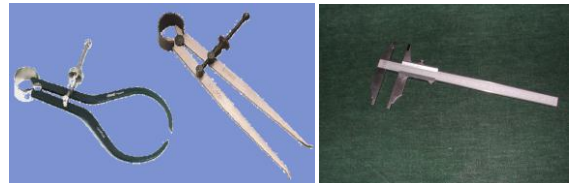

Thread

Nylon or Dacron thread may be required for use as the base line for measuring the keel rocker (curvature of the keel). The thread used needs to be thin so that errors do not occur due to its thickness, light so it does not sag much and strong as it is used under considerable tension. Fishing line is very good, but some types are liable to kink.

Calculator

To carry out the calculations required to assess the area of a sail an electronic calculator is an invaluable piece of equipment. It should have a capacity for doing square roots. Programmable calculators are good for making instant calculations, e.g. for calculating sail area in a development class. Portable computers have the additional advantage that they can store data in a presentable form as measurement proceeds, and can be particularly useful for recording data during regatta measurement.

Scales

The size of the equipment needed will depend on the work that is to be done. Weighing machines need to be regularly checked for accuracy - at least annually - and carefully stored and transported. It is important that the scale has adequate capacity with a capacity of at least 20% more than is needed. Weighing equipment should meet the requirements of OIML Class III in EU or equivalent standards in other parts of the World.

One should keep in mind however that the accuracy of an electronic scale is a % of the maximum weight allowed (to take a 2000 kg scale to weight a dinghy is a nonsense).



Electronic scales with digital readouts are ideal but should always be calibrated before use. For weighing dinghies a steelyard beam scale is accurate but a spring scale is normally satisfactory. For weighing keel boats Load cells are very accurate, but should be calibrated (twist problems). Alternatively dial reading beam scales can be used.

Whatever machine is used it should be calibrated i.e. the readings noted when known weights are added. It is particularly important that this is done over the range of the instrument which is to be used. See also section F of this manual.



Micrometre

Micrometres for sail ply thickness measurement shall have the following characteristics:

- Ratchet stop
- Measuring surfaces diameter as specified in **class rules** or, as a default, of 6.5 mm
- 400gf – 600gf applied to the measuring area
- Throat depth of approximately 21mm minimum
- Graduations to 0.001mm (0.00005in)
- Overall accuracy of plus or minus 0.002mm
- Flatness of anvil and spindle tips: 0.0006096mm or better or a parallelism of anvil and spindle tips: 0.00124mm or better
- Spindle lock

A set of standard feeler gauges are also required when checking cloth thickness.



G.2 Purpose-designed measurement tools

The following items of equipment are useful for measurement in a wide range of classes and may be produced from simple materials using only basic tools. Some classes offer packs of tools for the class produced by a builder to proven designs and occasionally run measurement seminars to demonstrate their use.

Sheerline Jigs

A means of accurately determining the positions of the sheerline by transferring the line of the topsides to the top surface of the deck is often required. For boats with straight or nearly straight topsides, such as most hard chine boats, a 'C' template (on the left) is adequate. If there is considerable curvature then the sheerline jig shown on the right is better. This jig adjusts to the curvature of the hull and projects the curve up to the sheerline. However, it should be noted that this device assumes the topsides to be a circular curve, and if it is not then an error will occur. To overcome this point in one-design classes with curved topsides C-templates can be made for each measurement station using the lines plan, or preferably full size sections of the hull.

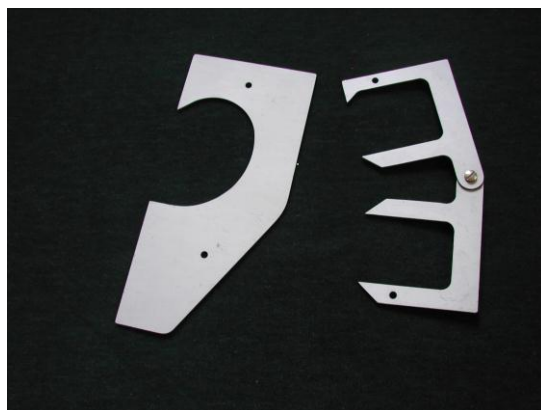

Wedges

A calibrated wedge to measure the clearance between items and a hull template and the hull is often helpful. It can be made of metal or plastic and should have its thickness at various points marked on it. However, a wedge should be used with caution (see Section F).



Go-No go Gauges

Examples of purpose-made measurement tools would be tools like a "go-no go" gauge for measuring a spar section or a transparent template to check sail numbers.

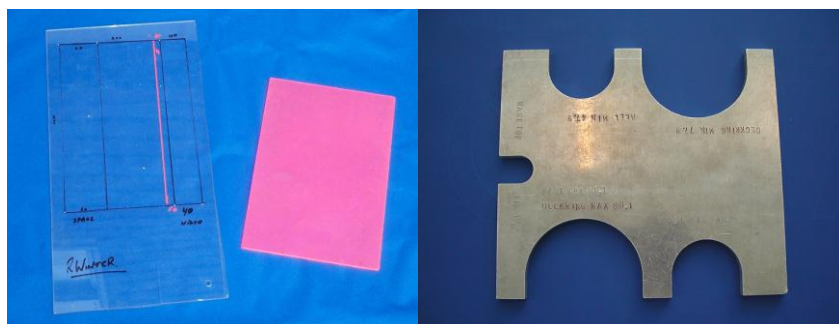

Water tube

Measurement of boats on uneven or sloping ground requires a means of transferring a level from one end of the boat to the other. Although a surveyor's level can be used, a cheap and simple alternative is a flexible tube filled with water. The tube must not have any 'air locks' in it and the internal diameter of the tubes should be at least 8 mm. The smaller the tube the more rounded the top of the water will be, which is our reference plane, and the more difficult it gets to take accurate readings. The length of the tube required of course depends on the length of the boat to be measured. About six metres is required for a boat 4.70 metre in length, but for a larger boat additional length would be

needed to allow for the increased depth of the hull as well as its longer length. For ease of use it may be desirable to use a reservoir of water and to have the tube in two pieces.

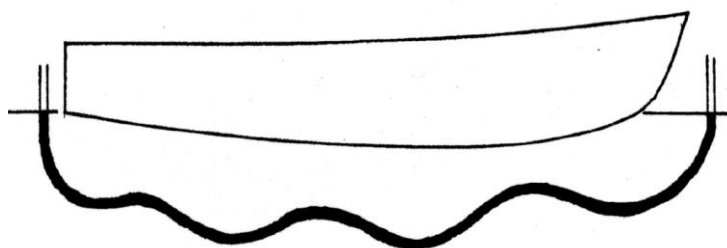

Manometers

A simple manometer or a similar device with a digital pressure meter may be used to test the air tightness of buoyancy tanks.

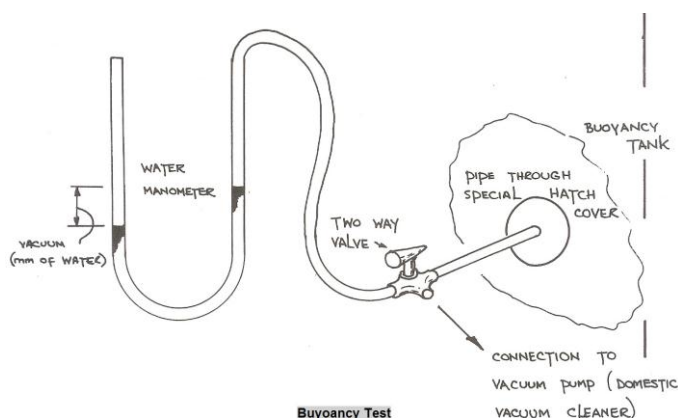

Weights

Some classes require that the boats' buoyancy be tested by placing iron weights in the swamped boat. A selection of weights totalling 200 kg will normally be sufficient, and should include 8 x 20 kg, 3 x 10 kg and 2 x 5 kg.

Measurement Frame

This piece of equipment (sometimes known as a Chippendale Square, after its inventor) is illustrated below. It is used for taking cross section measurements of small hard chine boats such as the Fireball and Enterprise.

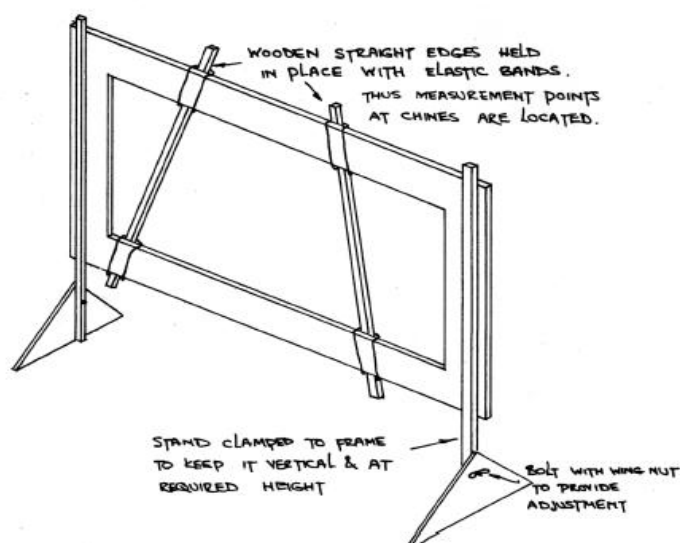

Hull Baseline systems

Beam baseline systems are easy to use in dinghy hull measurement and an affordable alternative to specialized jigs. They can be crude or highly elaborate depending on personal taste and the desired level of flexibility: the system shown below may be adapted to suit a number of different classes in a matter of minutes using sets of interchangeable fittings. In addition, car jacks are useful in setting up the hull on the desired trim (hydraulic jacks for bigger boats).



Stop watch

Electronic stopwatch: 1/100 sec resolution.

Electronic timer with photo gate (quartz crystal, not RC), resolution 1/10000 sec



G.3 Specialized tools



The gadget on the left can be used to measure centreboard case inside widths. The two cylinders are spring loaded and adjust to the width, then the knob at the bottom is tightened and they stay in place; the actual dimension can be taken by using a calliper.

The tool on the right picture is a finger gauge, very useful for checking items like keel edge inside and outside radii.

Surveyor's Level

When setting up a large keelboat of, say, one of the ISAF metre classes, it may be more convenient to use a surveyor's level or a theodolite (below left) although a water tube can be used. A laser beam level (below centre) is also suitable if a great accuracy is not needed. For smaller boats, a self-levelling laser (below right) may be used to draw a continuous virtual “baseline” or to set a horizontal reference line.



G.4 Special Equipment

Coating thickness measurement

To control the shape of the keel, some classes require checking the thickness of the coating. There are mainly two typical non-destructive ways to achieve this control:

- Magnetic based instruments, but they work only on steel keels (Elcometer tool shown)



- Ultrasonic velocity based instruments; they work on any materials (Panametrics-NTD – Model 25 DL PLUS shown).

This precision microprocessor-based instrument uses pulse-echo techniques to measure material thickness. It can be linked to a computer (RS-232 communications port).

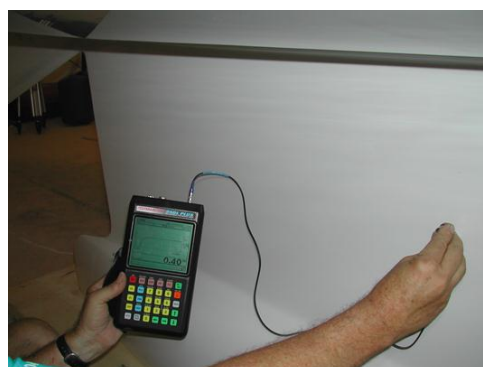

Optical or Laser Beam measurement of hull shape

The aerospace industry pioneered the development of portable and accurate laser coordinate measurement systems. The industry had a great need to get large parts manufactured at different locations to fit together seamlessly (hold a tolerance). Laser Trackers like the FARO send a beam of laser light into three or four cornered mirrors mounted in the centre of the sphere. The light is reflected back to the instrument sensors which update angle and distance giving an X, Y, Z position. After a few milliseconds the Tracker instrument has a history, and can track the sphere. This technology has been used to produce hull surface shape files and tested for Olympic Class hull comparisons with shape templates.



For smaller parts like e.g. a rudder, 3D digitizers like the digital arm (above right) may be used to create 3D shape files for comparison with the as-designed shape.

Hull shape measurement has been also attempted using reflector-less Total Station machines like the one shown here. This is the system recently adopted by the ORC for hull offset creation and operates in a “point and shoot” principle, without the need for a mirror sphere but the accuracy depends on the angle that the laser beam hits the target surface at.



Fiberscope

A tool like the Olympus fiberscope is a useful although high-end piece of equipment that allows the inspection of confined spaces like hull buoyancy tanks or the inside of a mast spar from an external location. It consists of:

- a light source, typically a 150 watt tungsten lamp
- a fibre optic cable to convey the light to the point of inspection
- another fibre optic cable to return the reflected light from the object of inspection to the view finder
- a viewing piece with focusing elements



Also incorporated in the viewing piece are four way angulation's controls that allow the steering of the inspection end of the fibre optic cable. A 50mm length at the end of the fibre optic cable can be steered to allow viewing over a hemispherical arc and with an appropriate camera photographs of the object under inspection can be taken as well.



More affordable equipment is becoming easier to get these days, like the compact inspection camera shown to the right: incorporating a LED light and the capability to send the image to an external monitor tools like this are more than adequate for sailing equipment measurement and inspection purposes.



G.5 Class-Specific Equipment

Some classes have developed special jigs for hull measurement, which are used mostly at major events, but similar systems are sometimes set-up in builders' premises for normal measurement of production hulls. In other cases, a hollow hull template made from the master plug may be used to check the rule compliance of the hull. The hull template can be easily fitted to the inverted hull and a visual inspection can be undertaken in a very short time. These systems tend to be bulky and expensive.





INTERNATIONAL MEASURERS' MANUAL

SECTION H

Hull Measurement

H	Hull Measurement	
H.1	Hull Shape Measurement	H 3
H.1.1	Introduction	H 3
H.1.2	Reference Systems	H 3
H.1.3	Hull Length and Width	H 5
H.1.4	Hull Profile	H 7
H.1.4.1	Simplified Keel Rocker measurement	H 11
H.1.5	Hull Sections	H 14
H.1.5.1	Section measurement using templates	H 14
H.1.5.2	Section Measurement for hulls with chines	H 18
H.1.5.3	Section measurement for development classes	H 19
H.1.5.4	Hull measurement with a model template	H 19
H.1.5.5	Generic Hull measurement: XYZ coordinates	H 20
H.1.6	Stem profile	H 21
H.1.6.1	Stem Templates	H 21
H.1.6.2	Rake of Stem	H 21
H.1.7	Transoms	H 22
H.1.8	Measurements in way of centreboard slot	H 22
H.1.9	Radius of chines	H 22
H.1.10	Deck camber	H 22
H.1.11	Sheer guards or rubbing strakes	H 22
H.1.12	Internal measurements	H 23
H.1.13	Fairness of the surface of the hull	H 23
H.2	Hull measurement with templates: Case studies	H 23
H.2.1	Toolkit	H 23
H.2.2	Baselines	H 24
H.2.3	Hull setup	H 26
H.2.4	Keel profile measurement	H 29
H.2.5	Template Measurement	H 31
H.2.6	Deck Measurement	H 32
H.2.7	FD Class hull measurement system	H 33
H.2.8	Tornado Class hull measurement system	H 36
H.2.9	Hull measurement of a “chine” hull: Case study for the Lightning Class.	H 38
H.2.9.1	Hull setup	H 38
H.2.9.2	Levelling and measurement of hull	H 39
H.3	Hull Weight	H 46
H.3.1	Hull weighing conditions	H 46
H.3.2	Underweight boats and weight correctors	H 47
H.3.3	Weighing at Major Events	H 47
H.4	Weight Distribution	H 49
H.4.1	The “Lamboley” Swing Test	H 50
H.4.2	Weight Distribution and Centre of Gravity: Practice	H 53
H.4.2.1	Errors and their reduction	H 56
H.4.3	Snipe Class swing test & Lightning bounce test	H 58
H.4.4	Dragon Class swing test	H 60
H.4.5	Star Class swing test	H 63
H.4.6	Stewart 34 Class swing test	H 63
H.4.7	Yngling Class tilt swing test	H 64
H.4.8	Bifilar suspension test	H 66
H.4.9	The complete boat	H 68
H.5	Buoyancy	H 70
H.5.1	Buoyancy apparatus	H 70

H.5.2	Immersion buoyancy tests	H 71
H.5.3	Buoyancy tank air test	H 71
H.5.4	Buoyancy inspection	H 72
H.6	Measurement with Ultrasonic Thickness Gages	H 72
H.6.1	Introduction	H 72
H.6.2	Considerations	H 72
H.6.3	Getting Started	H 74
H.6.4	Technique	H 75
H.6.5	Data	H 76
H.7	Laser Measurement Methods	H 76
H.7.1	Laser Tracker	H 76
H.7.2	Total Station	H 80

Hull measurement is not limited to shape control: hull weight and its distribution, scantlings (hull skin thickness, size and position of stiffening members) and buoyancy may also be prescribed in class rules and therefore have to be dealt with by the measurers. ERS 2013-2016 don't offer a standard set of definitions so uniformity in methods and tools is impossible, but the principles are more or less the same and classes follow variants of a small number of main themes. Each of the following sub-sections deals with the main aspects of hull measurement in detail.

H.1 Hull Shape Measurement

H.1.1 Introduction

Establishing a practical method of measuring a hull to determine its shape to a high degree of accuracy is probably the hardest aspect of creating a good set of class rules, particularly for one-design classes where the objective is to ensure that the hull shapes are as identical as possible. This section outlines the principal methods used to determine hull shape and appropriate techniques for measurers. However, it is important to measure in the way prescribed in the class rules if details are given.

Hull shape measurement is the procedure to get certain dimensions of a hull's external surface, and finally compare the hull shape with the original as-designed shape. The latter may require the use of special templates which outline the "standard" shape of a particular "section" of the hull, or—in case the hull shape permits, as in chine hulls— may be accomplished with direct comparison to a set of XYZ offsets.

Measurements usually include hull length, width (beam) measurements between certain points, keel profile shape (rocker), bow and transom profiles and of course the external shape of the hull in specific sections (stations or "frames"). In addition, class rules may specify other construction details such as internal or external radii at corners, edges, gunwales etc.

H.1.2 Reference Systems

To measure a hull, one needs a Hull Datum Point which is the starting point for taking measurements from, and a Cartesian axis system to define the major axes: longitudinal, vertical and transverse. These are related to a "baseline" defined in the Class Rules (usually an imaginary line parallel to the designed waterline) and the hull centerplate (hull in Measurement trim). Once the reference system is defined and in place, measurement "stations" can be defined as transverse sections "cut" through the hull at certain longitudinal positions according to class rules.

ERS H.3 states: For a boat, unless otherwise specified, words such as "fore", "aft", "above", "below", "height", "depth", "length", "beam", "freeboard", "inboard" and "outboard" shall be taken to refer to the boat in measurement trim. All measurements denoted by these, or similar words, shall be taken parallel to one of the three major axes.

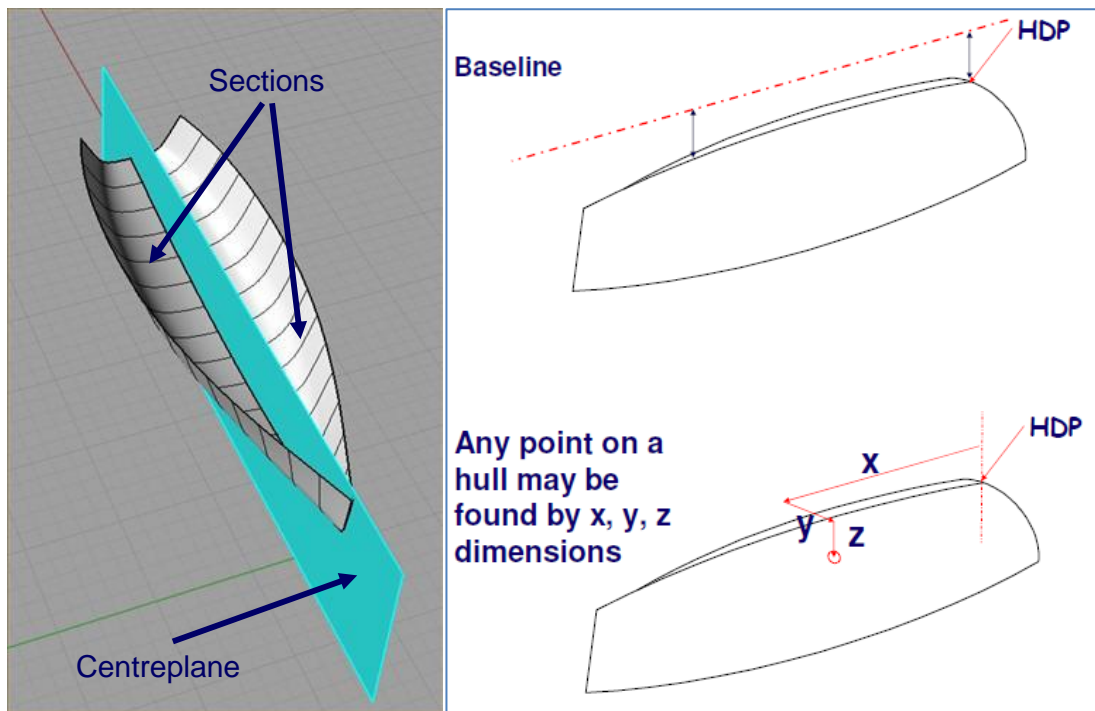

Figure H.1.2.1 Basic terms

The standard Cartesian axis system may be called the “Gravitational Coordinate system”. Locating the measurement stations at the sheerline and keel needs special equipment and takes time to set up properly and accurately; therefore some classes have taken another route, defining their measurement stations at pre-determined points along the curve of the sheerline and keel, eliminating the need for precise levelling of the hull: this is the “Hull Coordinate system”.

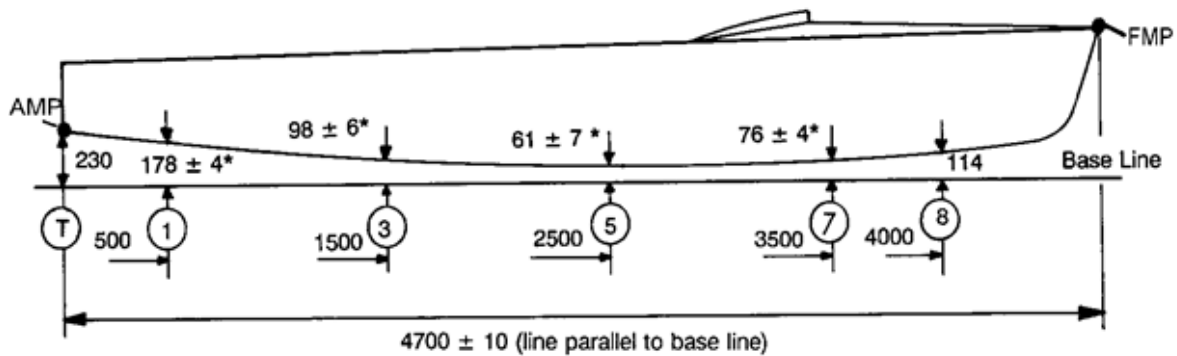

Figure H.1.2.2 Gravitational Coordinate System

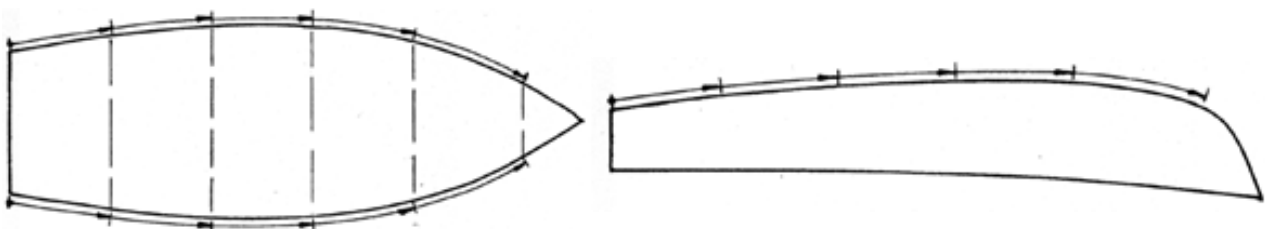

Figure H.1.2.3 Hull Coordinate System

The major advantages of the “Gravitational coordinate system” are:

- It precisely conforms to the design hull sections
- Controls hull twist and bend as the templates are precisely aligned

- The keel rocker is defined by the template positions.

The major disadvantages are:

- Precise alignment systems are very expensive.
- Although systems like the one developed for the Europe class in 2004 can be easily transported, systems like those made in the past for the 470 and Finn were cumbersome and bulky.
- Requires a stable floor.
- Takes significant time to set up.
- The hull has to be carefully aligned relative to the template system, which takes time.

The major advantages of the “Hull Coordinate System” are:

- The hull doesn’t need to be levelled, or even very stable (has been used on a grass lawn)
- Very fast to set up the templates, especially if the template reference marks are permanently scribed on the hull.
- No expensive frame for locating the templates or levelling system for the hull is required.
- The templates and measurement equipment can be easily transported.

The major disadvantages are:

- The planes of the template may not precisely correspond to the design section planes, but in most cases this is negligible.
- The FD system allows “banana boats” and hulls that are twisted. Neither of these would be fast, so this is unimportant. Furthermore it is to some extent controlled by the keel rocker measurements.
- The obvious criticism of the hull coordinate system is that if hulls have significant tolerances on the beam or keel rocker, then for a given measurement around the sheer line, or centreline, the fore and aft position of the template will not be identical for different hulls. For the Yngling and Soling, where the reference marks are in the deck moulding, all of which derive from the master plug, the distances around the deck flange should be essentially identical for all hulls, so there is good reproducibility of template position at the deck. The Star Class has resolved the issue by having different station positioning distances for each approved mould. In that case, each station is marked in the same position as if the hull was levelled using a baseline Gravitational coordinate system first.

There are also cases like in the Yngling Class, where a mixed system is used, including elements of both gravitational and hull coordinate systems: the template positions are specified by measurements along the sheer lines but not along the centreline. The latter are replaced by measurements along the baseline, i.e. in a “Gravitational Coordinate System”. This, at least in principle, makes template measurement at regattas impractical and fundamental measurement much more time consuming.

H.1.3 Hull Length and Width

The length of the hull has a fundamental effect on the performance of any sailing boat and it is therefore one of the principal measurements. To measure length accurately it is important to measure along the correct axis and to establish the exact end-measurement points of the boat.

For one-designs, length is normally measured parallel to the baseline. However, for some one-design classes, length is measured along the deck to facilitate measurement. In these cases the axis of measurement is not necessarily parallel to the baseline and care must be taken to avoid errors caused by the tape measure being deflected from a straight line by fittings or a breakwater on deck.

The aft measurement point (AMP) from which lengths are measured (HDP or Hull Datum Point) is usually the intersection of the transom and the centerplane of the hull at the keel line (Figure H.1.3.1).

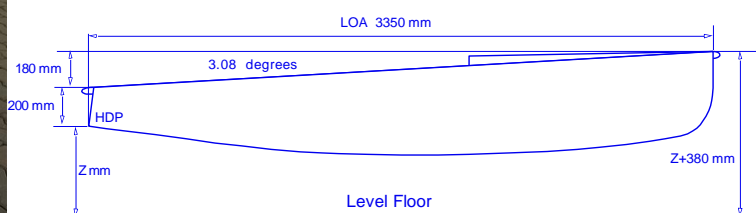

Figure H.1.3.1 HDP

Figure H.1.3.2 Deck overlaps

The hull length according to the ERS includes any deck overlap, measuring up from the aft-most to the foremost point of the hull and excluding fittings (e.g. 420 Class). However, class rules (e.g. Europe, 470 Class etc.) may specify that the deck overlap is excluded (Figure H.1.3.2). Class rules may also define a Forward Measurement Point (FMP) and then, with the baseline horizontal, the measured length is the distance between vertical planes through the HDP and FMP. Normally, fittings (like the rudder fittings on the transom) are excluded from the overall length measurement.

The measurement of the overall length of a dinghy can be carried out with the hull either the right way up or inverted. However, if working on a level surface it is frequently more convenient to measure the overall length when the boat is inverted. With the baseline horizontal the ends may then be plumbed down from the measurement points to the floor using a plumb bob or vertical spirit level and the length measured between the marks made.

For development classes length measurement can be difficult as they do not have base lines and the waterline position is not clear. In dinghies it is common to have a vertical stem and transom in order to gain as much advantage as possible from the available length. If the measurer sets the boat up with the stem and/or the transom vertical he has no means on knowing whether the boat is level because the waterline may not be in the assumed position.

Although the physical problems of levelling up a large boat of, say, one of the International Metre classes, are greater than for a dinghy, the problems of locating the waterline tend to be simpler. The designer will have gone to considerable trouble in order to accurately establish its position during the design stage. If the yacht is being measured for the first time the plans will be made available to the measurer, or the builder will have accurately positioned a mark to indicate the position. In the Metre classes the marks are required at each end of the waterline and the yacht has to float to these marks.

Width or beam measurements are taken parallel to the hull's transverse axis. Class rules may specify the measurement point as the sheerline (intersection of the hull surface and the deck), thus excluding any gunwale rubbing strake or deck flange.

H.1.4 Hull Profile

The hull profile on the centreline, sometimes called the keel rocker or hull rocker, is normally measured perpendicular to the base line. If the base line is set up horizontally, then all depth measurements can be taken vertically.

There are many ways in which the base line can be supported, but whatever method is adopted it has to be such that the base line is accurately and strongly supported, and that the sag of the line is very small. Sag cannot be eliminated totally although by using a thin lightweight line (Figures H.1.4.1 & H.1.4.2) and considerable tension the sag can be reduced to negligible proportions. The sag can be estimated as described in section F, or can be measured with a laser beam.

Some measurers claim that the only satisfactory equipment to use is a beam. However, beams also sag and if of wood may warp. Stiff aluminium beam sections should always be used with the large dimension vertical (Figure H.1.4.3) and then yield acceptable results, having maximum vertical deflections at mid-span of typically less than 1 mm, which again may be checked on the spot with laser lines/levels.

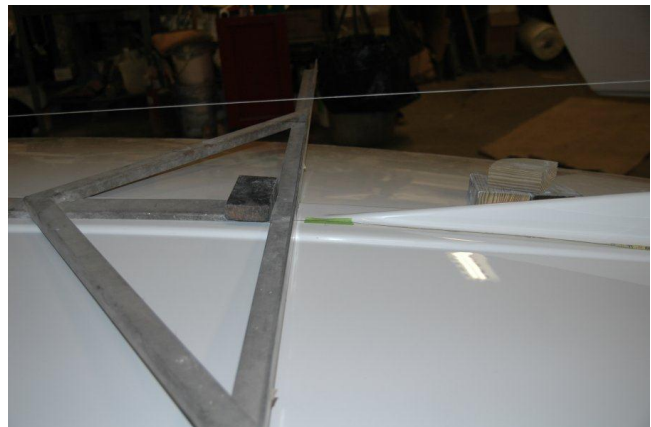

Figures H.1.4.1 & H.1.4.2 *String Baseline*



Figure H.1.4.3 *Beam Baseline*

A combination of both systems, where the beam is only there to support the line, works also well, the lightweight line going around two screws or nails fixed at the ends of the beam. In this case, the problem to introduce the tension of the line is easily solved by one weight at each end of the beam.

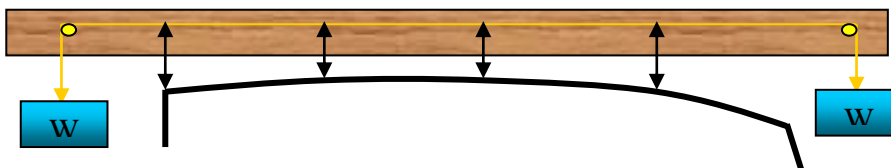

Figure H.1.4.4 *Combination Baseline*

The base line can also be materialized by a laser beam combined with a spirit level (figure H.1.4.5), or a surveyor's level (H.1.4.6):

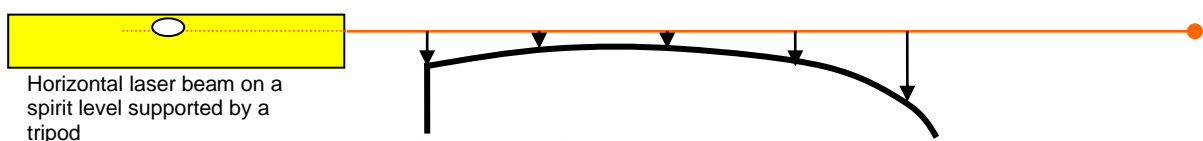

Figure H.1.4.5 *Laser Baseline*



Figure H.1.4.6 *Dumpy level Baseline*

The thickness of the laser beam (1 - 2 mm, for the cheapest tool) can be a problem if the rocker is near the limit.

When using a thin line as a baseline, the forward attachment point of it is usually positioned on part of the boat where it is difficult to support a base line. As it is necessary to fix it at the correct height only, the base line can be tied to anything that will provide a rigid support forward of the hull, for example a nail in a wall or door frame. In some classes such as the Enterprise and OK, it is necessary to extend the base line forward in order to carry out the measurement of the stem, and thus supporting the base line beyond the hull can help the measurer. In this case the boat must not be able to move even if the measurer leans on it.

The International Tornado Class controls the keel rocker by sighting through 12,5mm diameter holes on the templates when all the hull section templates are in place. This provides an accurate and convenient method in the case of the Tornado because the templates are fairly small. With larger templates on a hull there might be difficulties in positioning all the templates simultaneously and keeping them in place.

The hull has to be supported in such a way that it is not twisted and does not sag or hog. This is especially important for keel boats for which the keel should be supported. Whatever method is used to support a hull it is advisable, if the hull is a long one, to place the supports to minimize any deflection of the hull. This can be achieved by putting the supports about one-quarter of the length of the hull from each end. It must be made clear that all hulls of that particular class should be supported for measurement in the same way, and it should be part of the class rules or hull measurement instructions if possible.

Some classes have developed special jigs for hull measurement, which are used mostly at events, but similar systems are sometimes set-up in builders' premises for normal measurement of production hulls (Figures H1.4.7-H.1.4.12).



Figure H.1.4.7 *The Spanish 470 Jig developed for the 1992 Olympic Games*



Figure H.1.4.8 Spanish 470 Jig with a hull on top (left) and the modular framing and levelling screws detail (right)



Figure H.1.4.9 The 2004 Europe Jig



Figure H.1.4.10 The Europe hull inside the jig levelled and aligned using car jacks



Figure H.1.4.11 *Jig details*

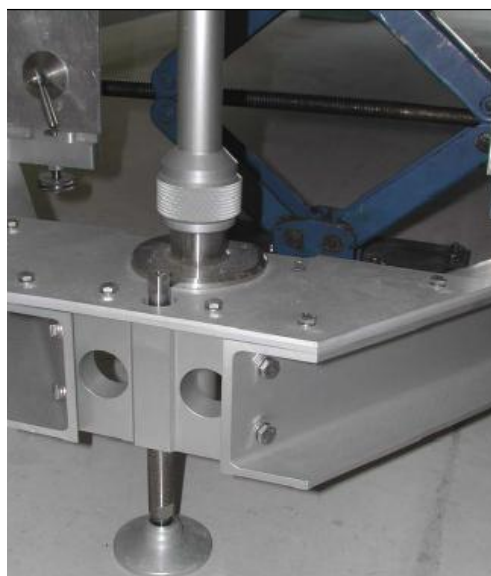

Figure H.1.4.12 *Levelling feet*

The template clamp, fine adjustment system, precision alignment line and levelling feet used to precisely position the templates so that they are vertical and in the section planes.

The systems shown above are ideal but enormously expensive, and in the case of the 470 and the similar Finn ones, they are bulky and thus not easy to transport even when dismantled. They require significant time and care to assemble and align, and require a solid concrete floor to rest on. During measurement, they need to be checked frequently for alignment and guarded against accidental movement.

H.1.4.1 Simplified Keel Rocker measurement

Hulls with the measurement points already marked on the keel line or defined along the keel may be checked using a simplified procedure: This is to eliminate the often time consuming, repetitive procedure of having to level both the hull and the baseline, or reference laser beam, before measuring the height of points on the keel line above the baseline in order to determine the rocker. The advantage of this method is that the perpendicular distances from the measurement points on the hull to the laser beam, or line, can be measured without vertical alignment. This can be quickly and accurately done by swinging the ruler about the measurement points and recording the minimum.

With a modern laptop it is then a simple matter to set up a spreadsheet which will convert the “**h**” measurements made in the measurement coordinate frame, to the required “**H**” data in the hull coordinate frame, i.e. relative to the baseline as defined in the class rules. With this conversion there is then no need to level either the hull or the reference laser beam. Measurement of the “**h**” values at the two reference points on the hull, which define the hull baseline, are used for the coordinate transformation.

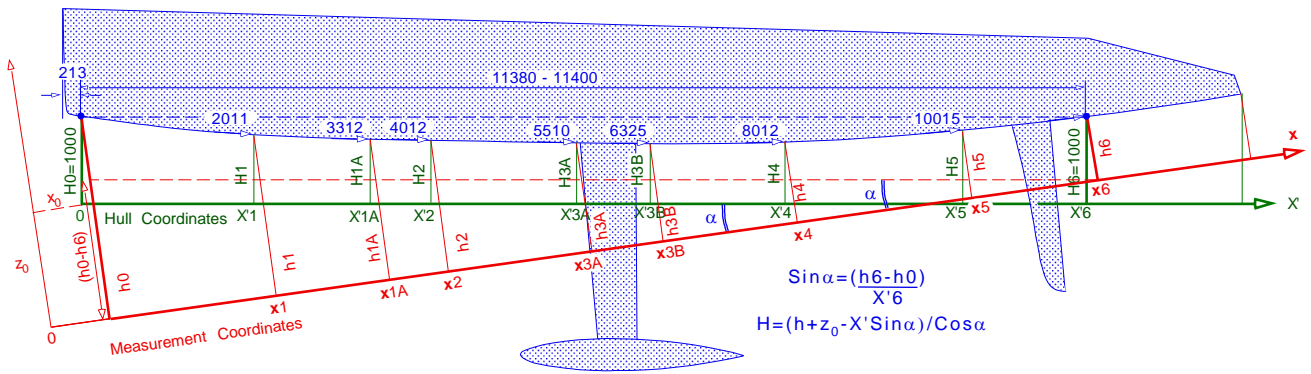

Figure H.1.4.1.1 The measurement, red, and Hull, green, coordinate systems are defined by the coordinates of the reference points 1 and 6 on the hull of an RC 44.

The hull baseline, i.e. X' axis of figure H.1.4.1.1 and H.1.4.1.2, to which the required depths H are measured, is defined by being at fixed perpendicular depths H_A and H_B from reference points “A” and “B” on the hull (points 1 and 6 in figure H.1.4.1.1). If the points “A” and “B” are defined as at hull sections, and the baseline is defined as parallel to the DWL, then their positions X'_A and X'_B along the hull X' axis are also specified. However, for classes such as the RC 44 and Soling, the measurement points are specified at distances from the HDP measured around the keel line. In this case the design spacing $(X'_B - X'_A)$, required for the transformation, will need to be calculated ahead of time from the class drawings. Thus $(X'_B - X'_A)$, H_A , and H_B are assumed known from the class rules.

The measurement baseline or laser beam is the x axis. The origin of these coordinates is shown at “0” in figure H.1.4.1.1, but can be chosen at x_1 or anywhere, as the x coordinate do not enter into the calculations. In order to transform the coordinate frame xz into frame $X'Z'$ it has to be moved by x_0 and z_0 , and then rotated by angle α . Then X' , Z' are given in terms of x , z and α by

$$\begin{aligned} X'_A &= (h_A - z_0) \text{Sin}\alpha + (x_A - x_0) \text{Cos}\alpha \\ H_A &= (h_A - z_0) \text{Cos}\alpha - (x_A - x_0) \text{Sin}\alpha \\ X'_B &= (h_B - z_0) \text{Sin}\alpha + (x_B - x_0) \text{Cos}\alpha \\ H_B &= (h_B - z_0) \text{Cos}\alpha - (x_B - x_0) \text{Sin}\alpha \end{aligned}$$

Solving for $\text{Sin}\alpha$, and z_0 gives

$$\text{Sin}\alpha = \frac{(X'_B - X'_A)(h_B - h_A) - (H_B - H_A) \sqrt{(X'_B - X'_A)^2 + (H_B - H_A)^2 - (h_B - h_A)^2}}{(X'_B - X'_A)^2 + (H_B - H_A)^2}$$

$$z_0 = h_A + H_A \text{Cos}\alpha - X'_A \text{Sin}\alpha = h_B + H_B \text{Cos}\alpha - X'_B \text{Sin}\alpha$$

If, as for the RC 44 $H_A = H_B$, then

$$\text{Sin}\alpha = \frac{(h_B - h_A)}{(X'_B - X'_A)}$$

An Excel spreadsheet, see figure H.1.4.1.3, may be programmed to calculate $\text{Sin}\alpha$, and z_0 and uses these values to transform the measured “ h ” values into the required “ H ” values, to the hull baseline. Note that no measurements of x (along the laser beam) are required.

$$H = \frac{h - z_0 - X' \sin \alpha}{\cos \alpha}$$

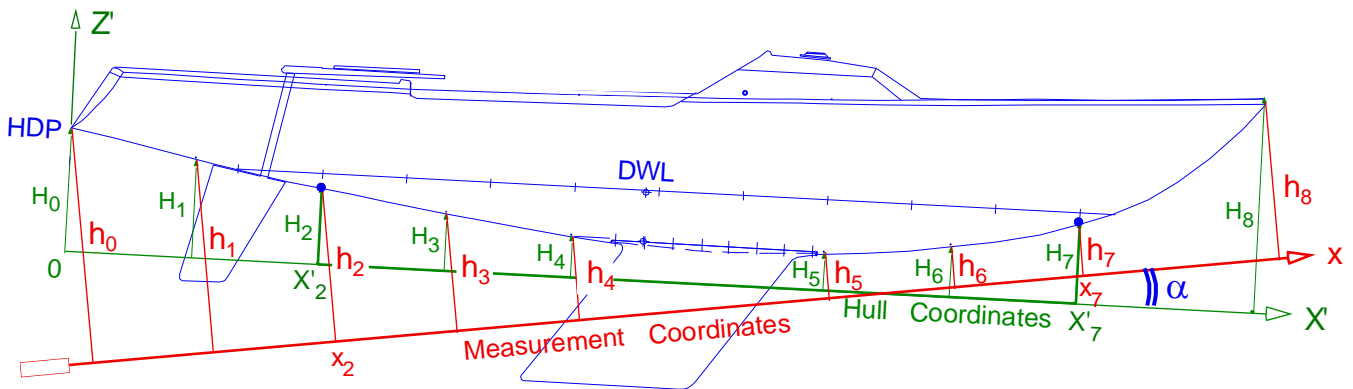

Figure H.1.4.1.2 For the Yngling the keel line measurement points are defined equally spaced along the base line. H_2 and H_7 , which are not equal, and $(X_7' - X_2')$ define the baseline (green). The measured h_2 and h_7 then establish the measurement coordinates (red) at angle α , neither being horizontal. Measurements of h_0 to h_8 are converted to the required H_0 to H_8 by the spread sheet, Figure H.1.4.1.3.

YNGLING

Keel line measurement sheet

Measurements in mm

$z_0 =$	455		HULL N°				
$\sin \alpha =$	-0.0799		ISAF#				
$\alpha =$	-0.0800		SAIL N°				
	Measured h	Baseline Distance from HDP	Calculated H	Min H	Design H	Max H	Delta= Calculated-Design
HDP	1133	0	680.50	670	677.5	685	3.00
Point 1	942	675	543.00	537	542.0	547	1.00
Point 2	767	1350	421.00		421		0.00
Point 3	615	2025	323.00	317	320.0	323	3.00
Point 4	471	2700	233.00	227	231.0	235	2.00
Point 5	340	4050	209.00	202	206.0	210	3.00
Point 6	363	4725	287.00	282	285.0	288	2.00
Point 7	461	5400	439.00		439		0.00
BOW	1110	6355	1167.00	1160	1170.0	1180	-3.00

Date:

Measured by:

Signature:

Builder :

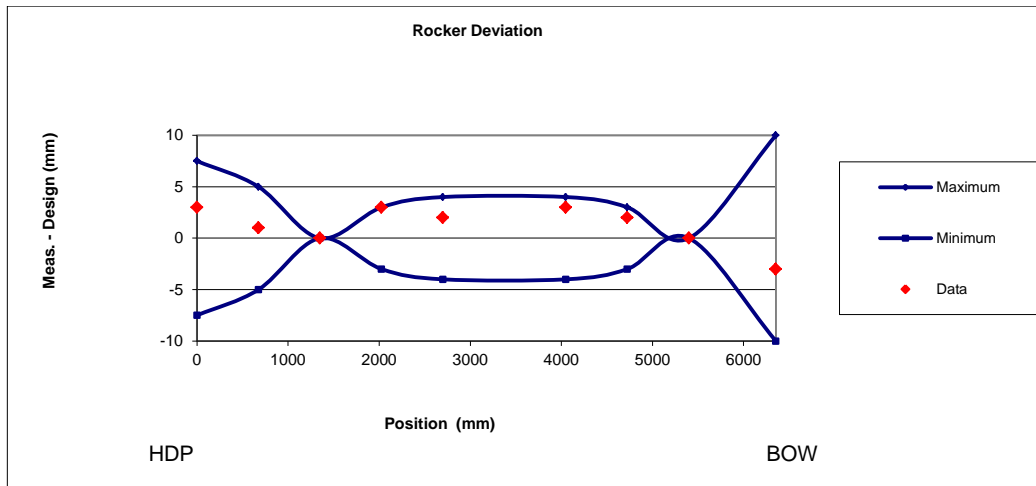

Figure H.1.4.1.3 Spreadsheet for converting Yngling measured “h” values to keel line depths “H” to the baseline.

H.1.5 Hull Sections

The shape of the hull is usually checked by measuring the shape of a series of sections through the hull, each a set distance from a reference point (Hull Datum Point). Distances are to be measured along the defined baseline. Each section through the hull where measurements are taken is referred to as a measurement station, and “Gravitational” or “Hull” Coordinate systems may be used (see H.1.2). Whatever the system followed, the position of the measurement stations should be clearly marked to facilitate easy measurement. This can be done by marking them with pencil or pen on paper masking tape stuck on the hull or by marking the hull using a ‘china graph’ pencil. It is not recommended to use felt pens directly on the hull as sometimes they contain dyes which can stain the gel coat of GRP boats. These marks should be on the hull topsides or at the sheerline, and in some classes are required to be permanent.

H.1.5.1 Section measurement using templates

After the 1940’s there were many new designs of racing sailboats which took advantage of new glues and moulded plywood construction to build boats such as the Firefly, Finn, 505 and Flying Dutchman, etc. and for these non-hard-chine boats a means of hull shape control was required. The lines plans were available giving waterlines, buttock and transverse sections, and these were used to develop section templates at a number of stations along the hull. Many classes also have bow and transom templates which control these parts’ shapes as well as serving to establish a baseline for keel rocker measurements.

The amateur construction of moulded ply hulls was not the precision technique that modern fiberglass moulding of hulls is today, and furthermore they tended to change shape with age, especially if not well looked after. Thus there had to be significant tolerances on the allowed shapes, typically ± 12.5 mm for example in the FD case. Since templates are designed to be the same shape as the design shape of the relevant section, plus an additional offset equal to the tolerance permitted at that station, the FD templates were thus made with studs on the centreline for location, with a shape that was then 12.5 mm larger than the design lines of the hull. The permitted gap between the template and the hull was then between zero and 25 mm. Now most fiberglass hulls are within a few mm of each other and furthermore, experimentation with hull shapes within the

tolerances have led to hull shapes which differ significantly from the original design and are used by essentially all modern competitors. The template gap tolerances have therefore often been adjusted and reduced to accommodate these developments.

Measurements of hull shape with templates are only as good as the templates themselves. There are therefore a number of features which are required for accurate template measurement. Modern templates are produced by CAD-CAM systems with the shape derived directly from digitized hull sections, so, apart from care having to be taken with precise scaling, the shapes accurately reproduce the design hull shape. However, modern water-jet cutting of templates require the use of soft aluminium rather than the harder Dural, and furthermore only allow cut outs (Figure H.1.5.1.1), rather than scribed lines marked on the template. Considering the soft material this has two major disadvantages, namely that the measurement is taken at a sharp point which can easily be damaged, and that there is no reference line 10 mm from the template edge which can be used to check that the template has not been damaged. Some templates are designed to have chamfered edges but these are difficult to produce by water cutting and considering the soft aluminium used, they should be very fragile.



Figure H.1.5.1.1 The ISAF-produced Yngling templates showing the triangular cut outs at the measurement points and the lack of a reference line 10 mm from the template edge. The crossbeam and brass adjuster are essential added details. Note the locating pin, which precisely maintains the width of the template

Most sailboat hulls are symmetrical, or at least intended to be, so many templates are made of two identical half templates and then assembled. For such templates it is essential that there are machined locating pins as well as solid clamping screws at the keel line join, and that a cross bar, also with machined locating pins., as shown in figure H.1.5.1.1 is used, if the template is not clamped into a frame as shown in figure H.1.5.1.2. The Yngling templates as supplied by ISAF have no crossbar and are joined by small plates and six 2 mm diameter screws, which is considered insufficient. The gap at the sheer between the two halves when screwed together in this way can vary by 7 mm. For accurate measurements cross bars with machined locating pins which define the beam measurement at the sheer, are essential and should be checked against rule specifications before any hull measurements are made.



Figure H.1.5.1.2 A full section FD template made of Dural with a pinned rigid crossbar and adjustable lugs at the sheer, for alignment. However, again there is no reference line at 10 mm from the template edge. The signature shows that this template has been checked against the reference Mylar plan

All template sets should have an identifying number, which should be recorded together with the data for the hull. Many classes have template sets from different eras and it is important to identify the set used for the measurements. In order to ensure that the templates have not been damaged or altered they should have a reference line precisely 10 mm from the measurement edge, however in many instances this is not the case. In that eventuality the measurer should have an accurate drawing of the templates on stable Mylar (figure H.1.5.1.3). Such a Mylar plan is easy to transport and should, if there is any doubt, be used to check the templates before measurement.

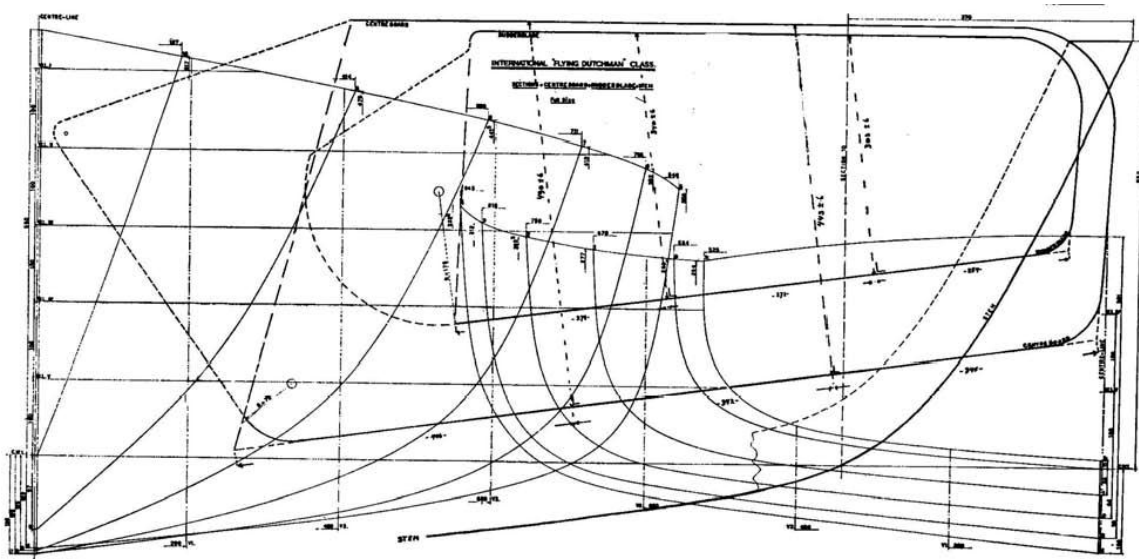

Figure H.1.5.1.3 The Flying Dutchman Mylar plan used for checking the templates, rudders and centreboards

If a plan is not available then there may be set control distances marked on the template and these should be checked. If there has been any distortion due to insufficient thickness of the metal then it is desirable to stiffen the template with wood or other backing.

Having located and marked up the measurement stations in one of the way described above, the following procedures may be generally used to set up the templates, unless otherwise stated in the class rules:

- Position the template with its centreline coincident with the centreline of the boat and with one face of the template coincident with the station marks. Templates located in

the “hull coordinate system” should be initially rotated until the gaps at the sheerlines are equal.

- Measure clearances all round template, where necessary recording both maximum and minimum clearances.
- Measure height of sheerline on each side.

It is essential that the template is accurately located, particularly towards the ends of the hull, since the shape of the hull changes rapidly towards the bow and stern and a small error in position can make a significant difference to the clearance recorded. The template can be held in its correct position using folding wedges at or near the sheerline as shown in figure H.1.5.1.4 or plasticine pieces (figure H.1.5.1.5). At the centreline masking tape or plasticine will hold the template in place.

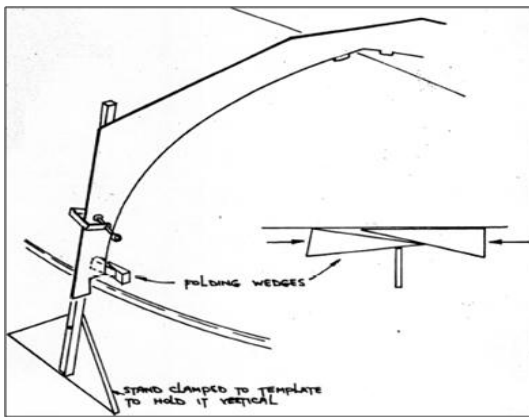

Figure H.1.5.1.4 *Template support*



Figure H.1.5.1.5 *Template fixing*

Clearance between the template and the surface of the hull is best measured using a steel ruler held parallel to the face of the template (figure H.1.5.1.6). Clearance may be also measured using calibrated wedges (figure H.1.5.1.7), about 125mm long and of different thicknesses. However, wedges can lead to errors, particularly near the bow and stern (Figure H.1.5.1.8) because the wedge measures the shortest distance between the hull and the template and not in the plane of the measurement station.

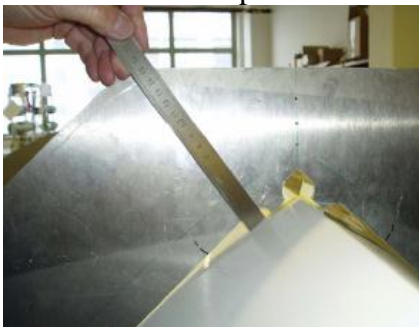

Figure H.1.5.1.6 *Ruler measurement*



Figure H.1.5.1.7 *Wedge measurement*

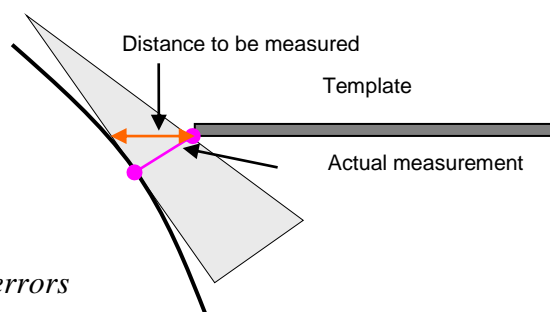

Figure H.1.5.1.8 *Wedge measurement errors*

H.1.5.2 Section Measurement for hulls with chines

The section shape of a chine hull is normally checked by measuring the height of chines and sheer lines above the base line and the beam at the chine(s) and sheerline. For ease of measurement, some classes measure chine rise and sheerline height from the keel at the centreline.

The chine measurement point should be defined, the normal definition being the intersection of the extensions of the surface of the hull each side of the chine. The sheerline is normally defined by the intersection of the deck upper surface and the outside of the skin of the hull, projected if necessary and can be found using a 'C' template or one of the sheerline jigs indicated in **Section G**.

Before measuring chine and sheerline heights, the hull should be levelled athwartships. Normally the hull will not have a twist in it and therefore the height of the two sheer lines at the transom can be equalized and the hull will then be level. However, if there is a twist the measurer has to establish a mean position. This can be done by measuring heights to the sheerlines at a number of sections on each side and then adjusting the hull to equalize the heights on each side at each section as closely as possible. All measurements of height to base line etc. have to be taken without moving the hull from this position.

Alternatively, the height can be measured on both sides and averaged, eliminating the need to accurately level the boat athwartships. However, if the hull appears to be significantly asymmetric the measurer should note it on the measurement form.

If a floor grid system has been used to establish the measurement stations at the sheer lines, the measurement points on the chines may be established by erecting two verticals at the sheerline marks. A string line held tight to touch both straight edges and the mark on the keel will locate the point on the chine.

Another way to measure the section shape of a chine hull is by using a measurement frame as shown in figure H.1.5.6. This device was developed by Jack Chippendale and is sometimes known as a Chippendale Frame.

The frame can either be supported at the level of the base line or directly on the keel. In the latter case the frame is more readily supported, but an allowance has to be made if height measurements are to be related to the base line. In either case the centre of the frame is supported vertically over the centreline of the hull and with the top frame horizontal. Care should be taken to see that the frame lies in the plane of the measurement section. Measurements are taken from the point on the hull to the nearest point on the frame. Beam at the chines is $B - (E + F)$. The height of sheer above the base line is $(A - J)$.

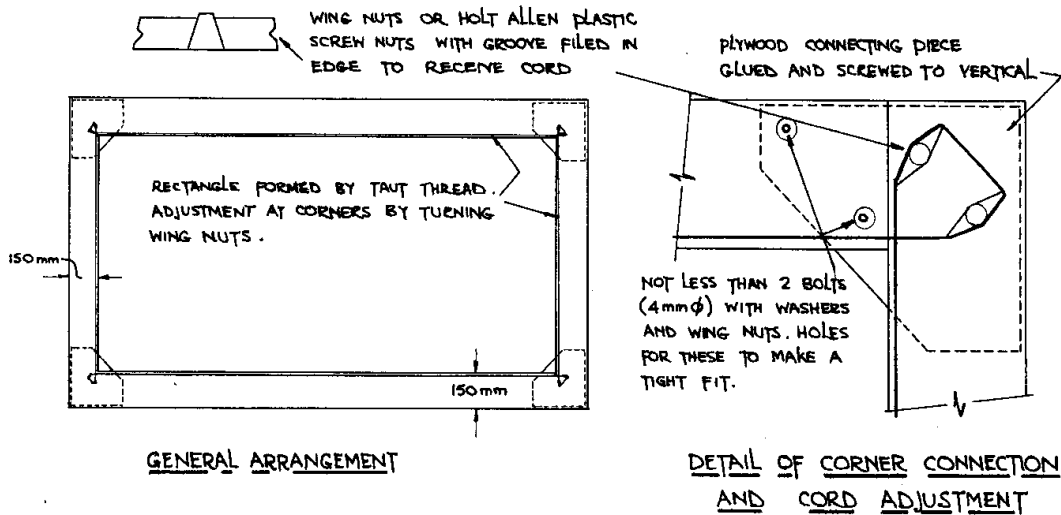

1. SUGGESTED MATERIAL FOR FRAME IS 8mm PLYWOOD.
2. FOR ACCURATE MEASUREMENTS FRAME MUST BE RIGID. THEREFORE CARE IS NEEDED IN CONSTRUCTION OF JOINTS AND IN DRILLING BOLT HOLES.
3. THE USE OF STRING LINE TO DEFINE RECTANGLE REDUCES NEED FOR WOOD FRAME TO HAVE PERFECTLY STRAIGHT SIDES. IF STRING IS NOT USED SIDES MUST BE STRAIGHT AND FORM RECTANGLE.
4. FOR USE OF FRAME SEE SECTION G.6.1.

CONSTRUCTION OF MEASUREMENT FRAME

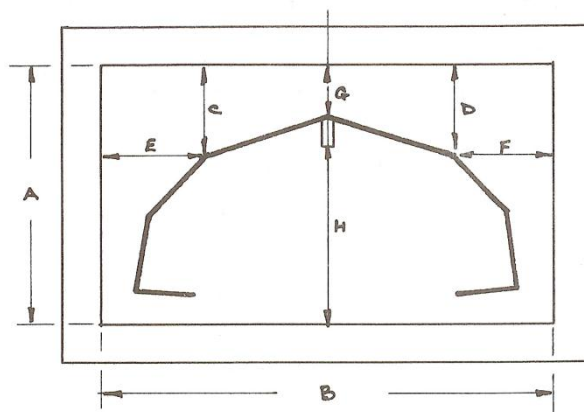

Figure H.1.5.6 Chippendale frame

H.1.5.3 Section measurement for development classes

Small development classes often have a 'rise of floor' restriction, i.e. a minimum permitted hull width at a fixed height above the hull centreline, to prevent very narrow beam in the area of the waterline. Rise of floor may be measured using callipers or by using a special template made from plywood to the dimensions given in the class rules. If callipers are used the bar must be horizontal when the measurements are taken.

H.1.5.4 Hull measurement with a model template

Some classes like the 49er use a hollow hull template made from the master plug to check the compliance of the hull. The hull template can be easily fitted to the inverted hull and a visual inspection can be undertaken in a very short time.

The only other tools required are a set of feeler gauges for measuring the gap, if found, between the hull and the



template. Any variation is then checked against the tolerance as specified within the builders' construction manual.

H.1.5.5 Generic Hull measurement: XYZ coordinates

Any point on a hull surface may be described by its XYZ coordinates, using a 3-axis coordinate system with the HDP as its zero point. Sections have the same X coordinate so for points on a particular section a measurer needs to measure their Y and Z dimensions.

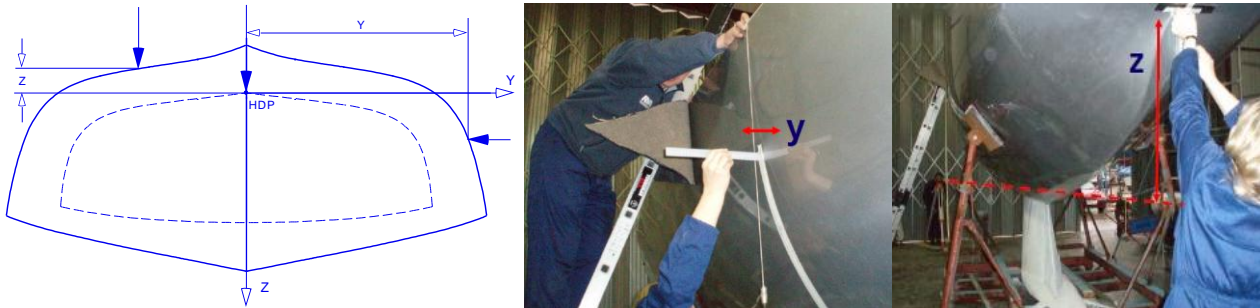

Using a surveyor's level, plumb bobs, a ruler and a beam with an attached tape measure, the hull may be set up for measurement as shown below:



The beam is needed only to hold the tape measure and sight the centre plane, as the horizontal levelling is controlled by the surveyor's level. Heights are measured with the level and the ruler, and not by using the beam. The hull is adjusted up and down until level (as defined by the rules). Then, sections are set forward of the HDP on the centre plane. Keel profile is measured again with the ruler and the level. Sections may be then set across the hull using a second beam and triangulation or a laser square. Any point on a section may be then defined by its height and beam dimensions.

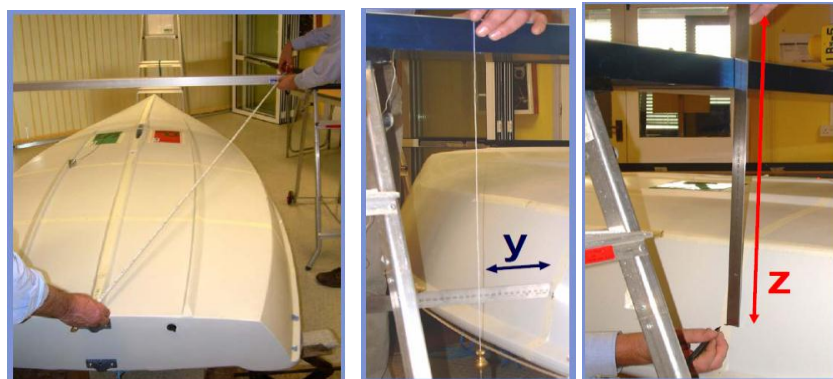

H.1.6 Stem profile

There are several ways of controlling the shape of the profile of the stem, some of which are described below.

H.1.6.1 Stem Templates

This is a template made in the shape of the curve of the stem allowing for the permitted tolerances. The method of using it varies from class to class and therefore reference to the appropriate class rules is essential.

The aft end of the template is usually located at one of the measurement stations although in some cases (for instance the Finn and Europe classes) an adjustment has to be made for any deviation from the designed overall length. For the 420 and 470 Classes the template has to be positioned relative to the base line in addition to locating its aft end at a measurement station.

H.1.6.2 Rake of Stem

Some classes with a straight but raked stem control the rake by measuring the position of the intersection of the base line and the extension of the straight portion of the stem.

With base line in position, a straight edge must be placed against stem and the distance from where it intersects the base line to the transom is to be taken. The distance to the nearest point on the forefoot from a stated point on the straight edge may be also required to be taken. Alternatively, the shape of the forefoot can be controlled by horizontal distances to a vertical at the stem from points situated at stated distances from the base line.

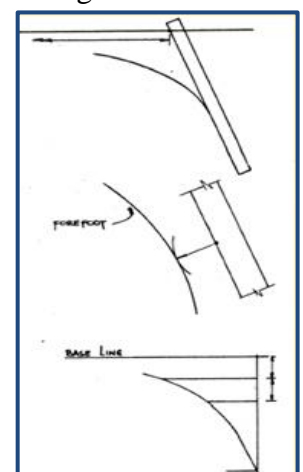

H.1.7 Transom

Transom rake can be measured using a spirit level or a plumb bob, but a simple and accurate way of doing it is to use a plywood rectangle

The measurements from the base line to the keel may be required to be taken perpendicular to the base line or vertically.

H.1.8 Measurements in way of centreboard slot

Usually there is at least one measurement station which coincides with the centreboard case opening. When this occurs, unless the class rules say anything to the contrary, the measurements are taken to the bottom of the hull projected to the boat's centreline as this is the point that would have been measured to when the hull plug was originally made.

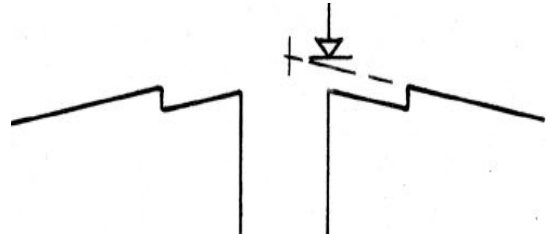

H.1.9 Radius of chines

Sometimes the class rules impose a limitation of the radius of the chine. The accurate measurement of this radius is not easy. However, in many cases actual measurement is not necessary because compliance with the rule can be checked visually by comparing the actual radius with the curves shown to the right.



If a measurement has to be made it is necessary to use a template made with the maximum permitted radius or a finger gauge. It should be noted that the angle at the centre of the radius must not be greater than the angle between the adjacent panels.



H.1.10 Deck camber

Deck camber at any transverse section is the maximum height of the deck above the sheerline at that section. It is measured by placing a straight edge athwartships approximately horizontally on the deck and measuring its height above each sheerline. Deck camber = $(A+B)/2$



H.1.11 Sheer guards or rubbing strakes

The usual way of measuring the width of these is illustrated in figure H.1.10.1, case A. The width is a plan width, i.e. it is measured horizontally from the sheerline. However, there are exceptions to this method. For instance the Finn Class measures the width in the way indicated in figure H.1.10.1, case B, and the FD Class does it as in case C.

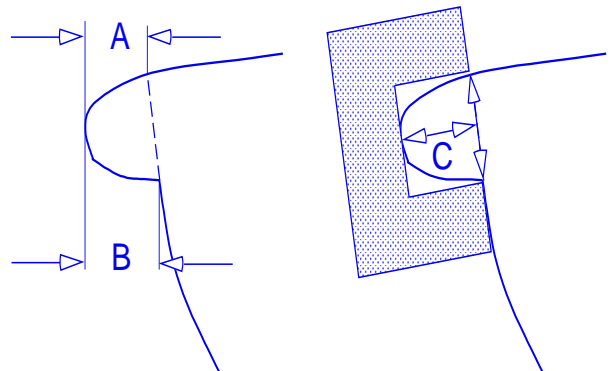

The depth measurement is either the vertical depth or the depth measured parallel to the hull side. The class rules should specify this.

H.1.12 Internal measurements

Measurements along the hull and to bulkheads, mast step and fittings etc. may be taken from a transverse plane passing through the aft measurement point. It should be noted that this datum plane may not be accessible for all measurements so the measurer may need to display some ingenuity in carrying out those measurements accurately. In respect of this, some class rules specifically refer to the inside of the transom as the measurement point.

Width, thickness, length etc. of components are measured as appropriate for that component or part and without reference to the hull axes.

H.1.13 Fairness of the surface of the hull

Several classes require the measurer to check that the surface of the hull is fair. This is normally done with the hull inverted, by laying a flexible batten on the hull surface. The ends of the batten are held down on the surface and the area of contact examined.

What is being looked for is an unfairness which will be shown by the presence of a 'hard spot' which causes the batten to lie away from the hull, or by a definite concavity in the surface. A concavity can be detected by means of a straight edge.

Care should be taken when examining a hull for fairness that a gap between the batten and the hull caused by the fact that the batten does not take up the same curve of the hull, is not mistaken for a gap caused by a 'hard spot'. Often it will be found that the batten, when held at its ends on the hull surface, will not lie on the surface. Light pressure applied to the batten over the centre of the gap will normally close the gap completely. If it doesn't, there may be a hard spot and therefore unfairness.

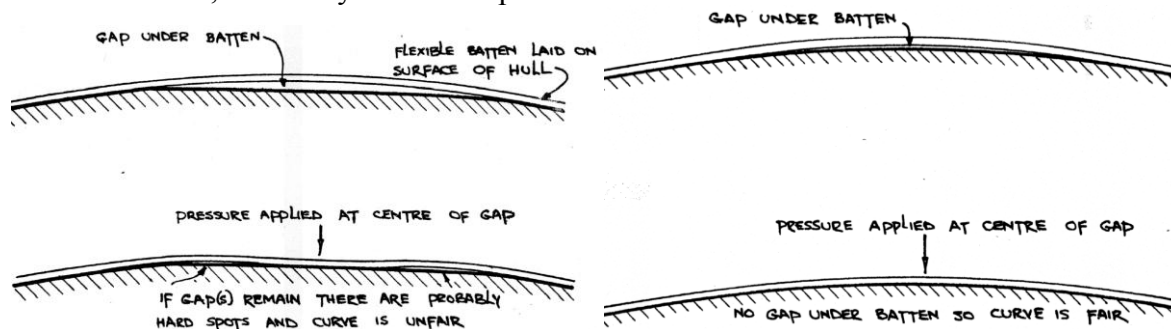

H.2 Hull measurement with templates: Case studies

The following is a guide on dinghy hull measurement using a beam baseline, as applied in various centreboard classes.

H.2.1 Toolkit

- A beam to serve as baseline, a little longer than the hull
- Big square (Torpedo Laser level or big Carpenter's square or equivalent)
- Self-levelling Laser or water-tube
- Ruler, tape measure, adjustable square
- Plumb bob, plasticine, pencils, masking tape
- Sheerline finder

- Official set of templates
- Car jack
- Trestles, support for the hull

H.2.2 Baselines

The base line can be a straight beam of an aluminium rectangular section, as light and stiff as possible: that may be accomplished by using tall and thin-skinned sections, but in all cases they should be stored carefully to avoid permanent deformations or other damage.

Sag in the middle is always present due to self-weight of the beam, but with the correct selection of section it can be minimized. For example, a 60mm X 25mm X 2mm aluminium section (height X width X skin thickness) sags about 0,75mm in the middle of the span in the case of a 420 hull ($3780\text{mm}/2=1890\text{mm}$ from HDP). This is the maximum found, and in other stations towards the ends of the hull it will be much less. The measurer should always take these figures into account when measuring a hull, especially in cases where the hull is made close to the limits.

All measurement stations should be clearly marked on the beam along with notes such as the minimum and maximum limits, and a steel tape can be fixed on the upper surface for quick reference. Obviously this is one of the main advantages of this system compared with a thread baseline.



Of great importance is the way of making the “legs” of the baseline, that is the pieces that actually touch the hull at the respective points according to the class rules, and there are various ways to do that:

- Using pieces –preferably of the same aluminium section as the baseline- cut in the correct length and fastened with bolts or clamps on the baseline beam. Great care must be taken to ensure that they are fixed at right angles to the baseline and the bearing points are exactly at the correct heights from the baseline. Another thing to consider is the designation of the baseline “edge” on the baseline beam, because the legs must be attached so they follow that edge: the recommendation is to assign the lower left edge of the beam as the baseline, and while the aft (transom) leg may be flush with the baseline beam’s left side, the front leg is better made in a configuration similar to that shown in the picture. In this way, it will be easier for the baseline system to stay put on the hull keel while in use. Otherwise, the baseline will tend to fall over at the front end. Teflon pieces may be attached at the edges of the legs, because aluminium tends to leave marks on the hull gel coat –as long as their length is included in the total length of the legs.



- Using the stem and transom templates themselves –if the class uses those like the 420, fastened with clamps (or even bolts) on the baseline beam. Great care must be taken to ensure that their scribe lines are perfectly aligned to the baseline. When using the templates as “legs”, it is impossible to have an arrangement on the front one to facilitate the safe positioning of the baseline. Therefore, care must be exercised to keep the baseline in place during measurement, and external supports may be used as well in the form of beams where the baseline may be clamped for extra security. This arrangement cannot be used in cases like the Finn, as the exact positioning of the stem template depends on the actual measured length of the hull and its difference from the “standard” class length.

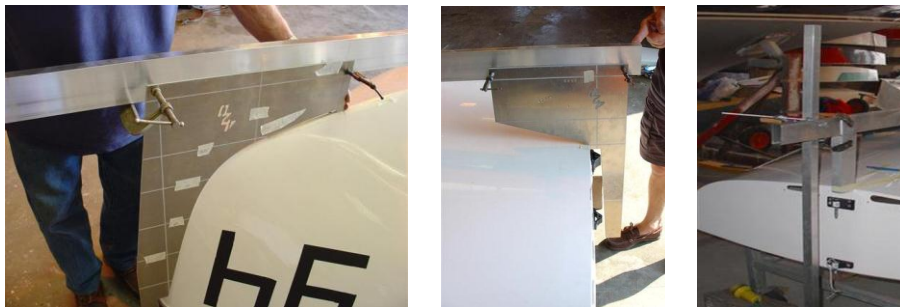

- It is also possible to use external supports for the baseline beam and fix it at the correct height from the hull but this is not recommended because it is more time consuming to setup and not as easy to keep in place during measurement as the other systems.

Using removable legs makes for a truly “universal” system, which may be used for various classes simply by substituting the legs for the class specific ones. Having the beam in parts allows the system to be used in shorter or longer hulls as well.

The modular “Strongback” system developed for the Finn and 470 Classes is such an example, and in fact this system was used at the 2008 Olympic Games, replacing the bulky jigs of both Classes.





H.2.3 Hull setup

The setup of the hull is fairly straight-forward: Above all, the hull has to be turned upside-down and supported in such a way that there is no induced twist and sagging is controlled. To minimize errors from hull sagging, it is recommended that all hulls of the same class are set up in the same way.

For the aft support, the transom edge is not always a good choice because many boats have curved transom tops, so the hull will sit on the highest point which is on the centre plane, and therefore it will be unstable. Therefore, the hull shall be supported at a point some distance in front of the transom: 420s and 470s can be supported only a few centimetres in front of the transom, while a Finn needs to be supported just in front of the aft tank. The aim is to support the hull on the side tanks in a way that will facilitate proper athwartships levelling: using small wedges or even cardboard pieces as shims on one side, the hull may be levelled athwartships with the help of a simple water-tube or bubble level. Reference points for the levelling shall be the sheerline points at the transom corners. Alternatively, this may be accomplished by using more sophisticated systems of car jacks and attached levels. If the support system can stay fixed in place and the measurement involves a number of boats, then it pays to level the support beforehand, ensuring that hulls will sit levelled each time.



For the bow, a car jack with some foam pads attached is to be positioned near the stem, but it must not obstruct the positioning of the stem template. Then, it will be used to lift or drop the bow as needed.



The HDP of the hull shall be defined next: This is the intersection on the hull centre plane of the transom external surface with the underside of the hull surface, both extended as necessary. For hull measurement purposes, and lacking another way of finding the symmetry plane of the transom, this shall be the point at the above said intersection at equal distances from the two sheerline points at port and starboard transom corners. It may be found using a measurement tape and it shall be clearly marked on the hull with a pencil or pen and a piece of masking tape for protection.

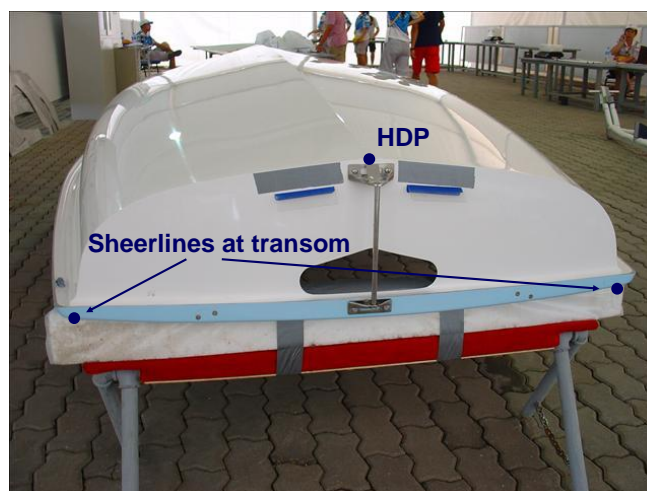

The baseline is then ready to be set on the hull and fixed with masking tape. Note that if legs are used, the aft leg must be made in such a way that the longitudinal “zero point” is actually a few millimetres inside the leg front edge, unlike the front leg, where the appropriate point as defined in the class rules is the aft edge of the leg. This is done because we need a small “dent” to help the baseline “sit” on the hull. The transom template –if there is one- may be used for tracing the correct shape of this dent. In the 420 case, if using the template as leg, the dent is already built-in.



The front leg shall be positioned so that the baseline is above the highest point of the keel at the appropriate station (station 9½ at 3780mm from HDP for the 420, station 8 at 4000mm for the 470 etc.). The baseline beam system must be made vertical (athwartships) using a plumb bob or a level. In this way, the vertical plane passing through the baseline, set as described above, coincides with the hull centre plane for measurement purposes.

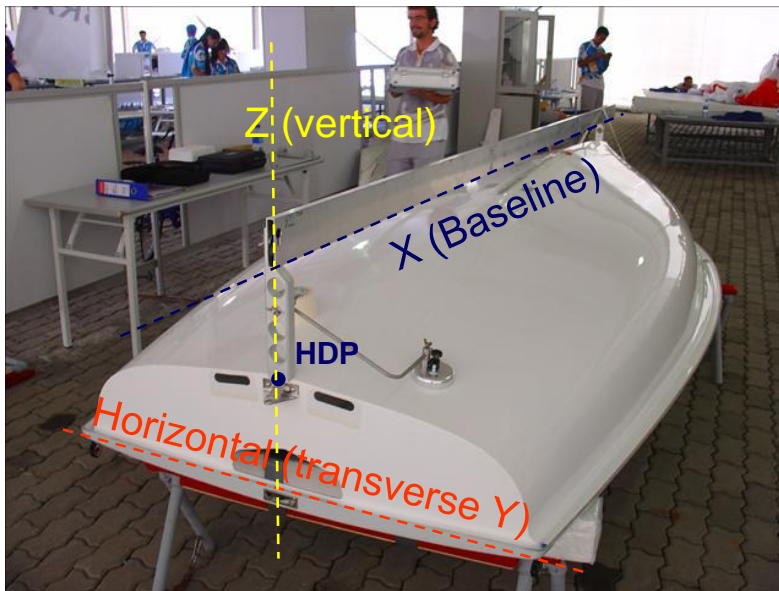

Using a water tube or a level (conventional or laser), the hull can then be levelled fore and aft with a few turns of the front support jack screw. The whole procedure takes very little time to complete. The fore and aft levelling of the hull is not really necessary but will help with some measurements as it allows the measurer to use tools like plumb bobs and certainly helps with template positioning at the later stages.

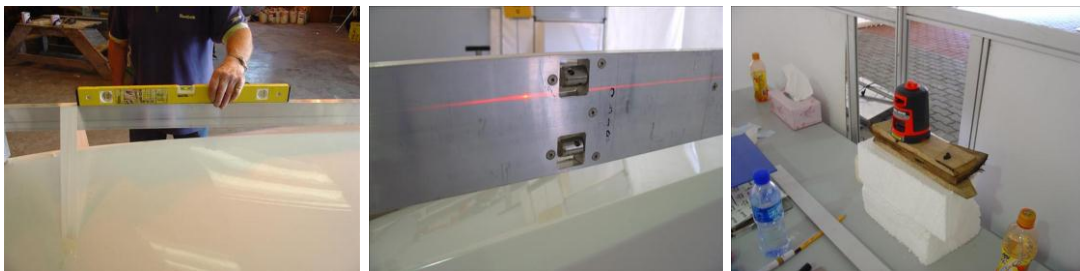

It is very important to fix the baseline system on the hull so it doesn't move, and even mark the contact points with pencil fore and aft for quick reference during measurement: if at some point it is discovered that they are not aligned anymore, then the setup process should be repeated. Tape is one way to fix the baseline, but ingenious systems with suction cups and fixing screws are also possible.



H.2.4 Keel profile measurement

With the baseline set and fixed on the levelled hull, the next step is to check the keel profile at the various stations and mark on the hull the station points for template positioning. The first can be done with an adjustable square and a steel ruler, but for the second a carpenter's square or a laser square is needed to extend each station on the hull sides (or the special pivoting square on "Strongback" system shown in some of the photos below).

The gunwale positions for each station can be marked using a plumb bob, and then the sheerline points can be marked using appropriate tools for each class: Finn and Europe need a sheerline finder tool; 420, 470 and 505 define those points at a set distance inwards from the gunwale edge.

Centreline station points shall be those found exactly under the baseline, even if the hull is not perfectly symmetric in construction: If the highest point on the keel seems to be offset to the side, the point under the baseline will be still marked as the "centre" of that station, but the keel height shall be the one found by measuring from the baseline to the highest keel point.

The last step for this part of the job is to measure the sheerline heights at the stem and the top of the transom, as well as the transom top deviation from the vertical (horizontal distance from HDP); these measurements will be needed later, to set the deck baseline.

For those stations that are in the centreboard case area a special tool is needed to bridge the gap: it may be made from two aluminium strips bolted together. Pencil or pen marks covered with masking tape shall be placed at all measurement points.

Warning: keel profile measurement for the Finn is done excluding the keel band (if present), but the keel band is included in the latest class rules for the positioning of the baseline.

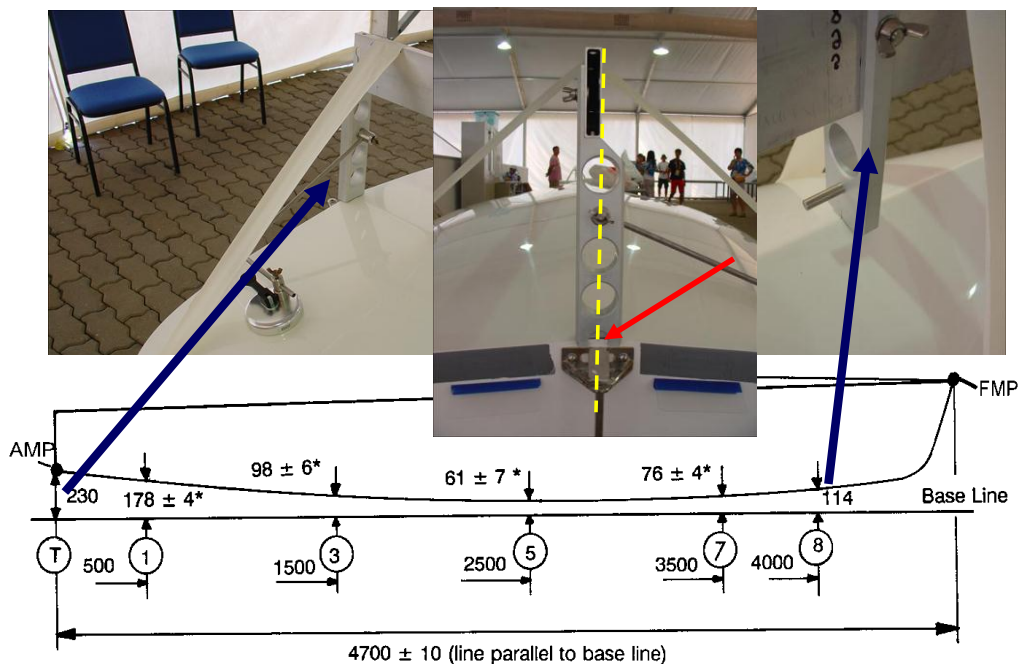



Keel profile

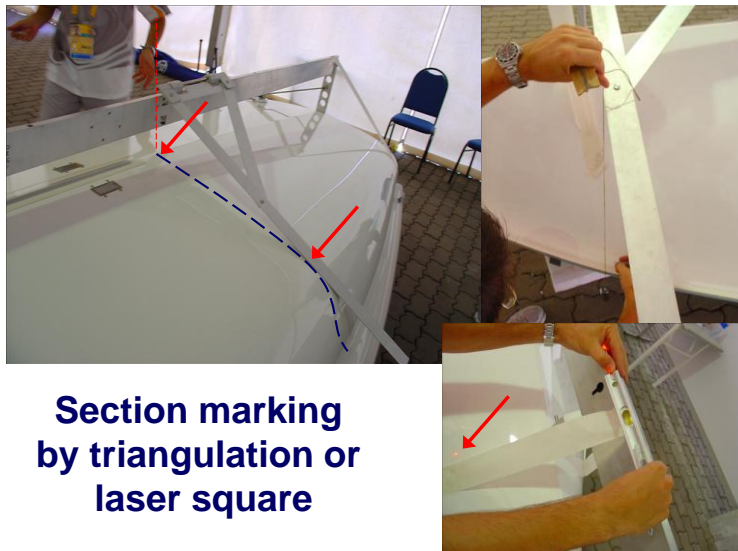
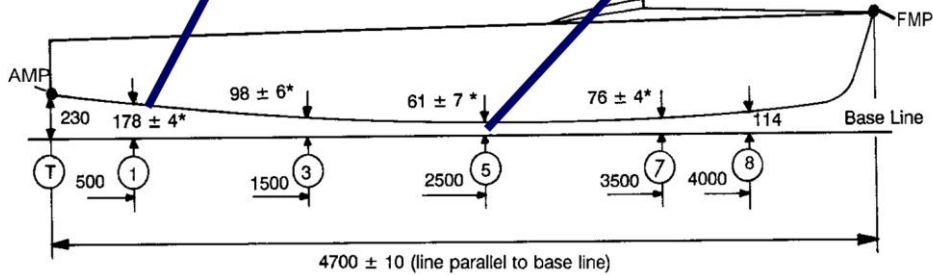

Section marking by triangulation or laser square

At this stage, the centreboard case, centreboard pivot and chain plate positions can be checked, and in the 420 case, if the stem/transom templates have been used as baseline legs, the profiles of the stem and transom. For that class, the transom surface radius may be checked at this point as well. Finally, the hull length between the transom corner and the stem may be measured using the baseline and a plumb bob or a square. If the forward measurement point is the extension of the stem on the deck, a tool similar to a sheerline finder may be used. Otherwise, the plumb bob will touch the foremost point to indicate on the baseline the length of the hull. Differences between the actual and the “designed” length will specify the correct fore and aft position of the stem template for Finn and Europe.

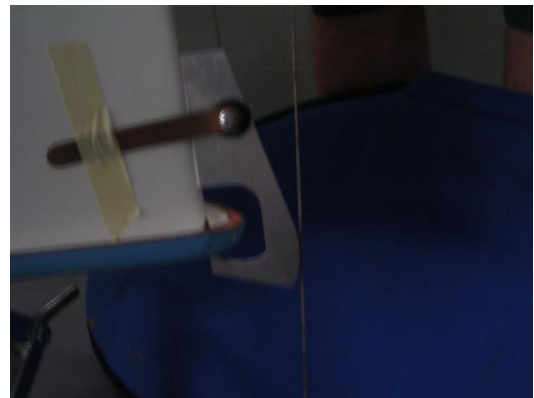

The height of the stem head from the baseline may be measured and recorded, even if there is no limit in the class rules for that: it will help the measurer set and level the hull for deck measurement.

H.2.5 Template Measurement

When the keel profile measurements and the station marking has been done, the baseline has to be removed (without disturbing the levelling of the hull), to make way for the templates. With three points marked on the hull for each station (centre and one per side), each template can be positioned easily and fixed on the hull with small pieces of plasticine on each side. The centre of the template shall coincide with the mark on the hull centre plane and one face of the template shall coincide with the station marks. The templates shall be initially levelled so that the sheerline marks on both port and starboard sides are on the same horizontal level. If the hull is levelled correctly, the self-weight of each template will help it stand vertically, without any other outside assistance, but for extra security, a support system may be used as well. It is essential that the stations for template positioning are accurately located, particularly towards the bow of the boat, since the shape of the boat changes rapidly towards the bow and a small error in positioning can make a significant difference to the clearance recorded. Finn and Europe stem templates have two nibs, one near each end, and they are positioned so that both nibs touch the hull. 420 and 470 stem templates have only one nib at the keel end and are aligned with the baseline using a scribe line on the templates themselves as reference for the baseline (horizontal) level. This is one extra reason for levelling the hull horizontally fore and aft, so the stem template may be set by using a simple level.

The Europe hull is measured in a fundamentally different way, as the templates are always levelled horizontally sideways and remain so at all times. Moreover, the templates are positioned in the centre plane at a height that depends on the actual keel profile difference from the original design values. One can imagine the Europe hull being checked exactly against the original design shape, with templates “floating” in space always at the same position relative to the “designed” shape. In classes like the 420 - 470, the templates “follow” the as-built- shape, since they are always positioned at a fixed distance from the hull at the centre plane (i.e. 8mm for the 420, 10mm for the 470). The Finn excludes any keel bands from hull shape measurement, so the templates actually have a cut in the centre to allow keel bands to fit inside. Therefore, the templates are touching the hull on both sides near the keel.

Minimum and maximum hull clearances from templates should be measured and recorded for both sides. The sheerline height is also to be recorded both for port and starboard sides. If the hull is not perfectly symmetric, and the template clearance is outside the limits at some point, the template may be rotated (NOT in the EUROPE!) at the centreline if that solves the problem, but the sheerline points shall be at all times within their respective limits and the exact positions of both sheerlines recorded so that the measurement setup can be repeated later if needed. A metal ruler held parallel to the face of the template shall be used for measurement of the template clearance. Use of a calibrated wedge is not recommended because it may lead to incorrect measurements.

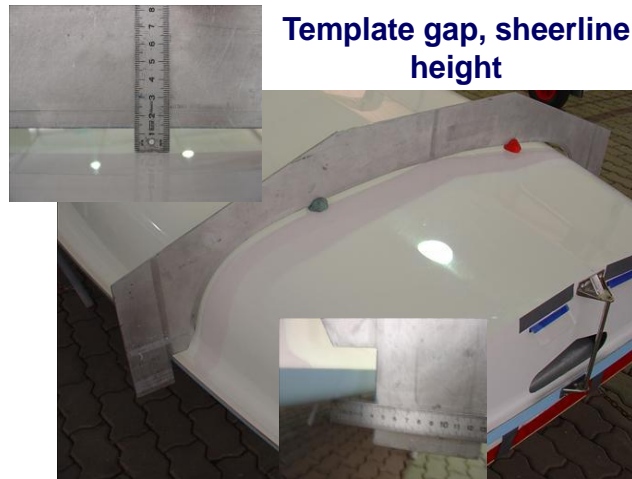

H.2.6 Deck Measurement

For deck measurement, the hull must be turned back upright; The same beam baseline may be used but with different height legs, according to the following system: by measuring the difference of the sheerline height between the stem and the top of the transom, two legs with lengths differing by that amount can be made. Enough length must be added to both legs for the baseline to clear the breakwater (if any). It is recommended that one of the legs shall be adjustable in length, to compensate for differences in sheerline heights between boats. Alternatively, the aft leg may be fixed at a set height and the baseline positioned -with the help of a vertical bar- at the appropriate height at the stem.

There is no need to level the boat fore and aft for deck measurement, since there are no templates to hang, unless the measurer is using plumb bobs to transfer measurement points vertically. It is recommended to use squares instead since they are easier to use, especially laser ones. If levelling is needed, the hull shall be levelled athwartships using the sheerline points at the transom corners, and the baseline for fore-aft levelling, as done previously for the hull.

Taking into account the horizontal distance of the transom top from the HDP, the HDP can be “transferred” on the transom top without significant errors.



The Finn Class is using a simplified method for setting up the hull for cockpit measurement, by taking a fixed vertical difference between the transom and stem of 468mm (the recommended method described above for the other cases is to measure exactly the equivalent of these “468mm” for each particular hull):

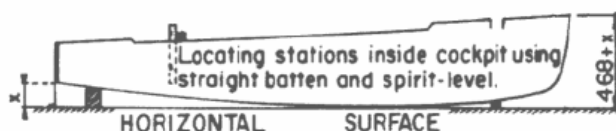

H.2.7 FD Class hull measurement system

The Flying Dutchman Class is using the simpler “Hull Coordinate System” and applies the following procedure (taken from the FD Class Rules):

“After measuring the overall hull length (done along the deck line), the **hull** is turned upside down and supported on trestles. The positions of the stations at the keel and the gunwale are to be determined by taking the following measurements from the outside of the transom along the keel and along the skin at the gunwale.”

Station	1	2	3	4	5	6	7	8	9
Keel mark	732	1283	1835	2385	2936	3486	4036	4587	5137
Gunwale mark	745		1856		2958		4065		5210

By using the numbers on the table, the three points required to define the template plane, which it should be pointed out may not correspond precisely to the section plane of the design drawing, are determined and marked on the hull and then the templates can be positioned. The measurement edge of the template, usually the forward side for the bow sections and the aft side for the stern sections, should be aligned with the reference marks. The centreline of the template must be aligned with the centreline of the hull, but this still leaves the rotation of the template around this point to be determined. This is generally fixed by making the template gap at the port and starboard sheer lines equal, and a lug is provided in order to maintain this alignment.



From the FD measurement diagram it can be seen that the hull is to be supported at $\frac{1}{4}$ and $\frac{3}{4}$ of the hull length, as suggested to minimize hull sagging. Doing a similar thing for the Finn or 470 would result in difficulties for the levelling of the hull: When trying to level a hull for the “gravitational coordinate system”, it is much more efficient if the adjusting screws are positioned very close to the transom corners and the stem head.

Compared with the beam baseline systems described in the previous sections, it is obvious that here the equipment needed is only the templates themselves. However the price to pay is lack of direct comparison to the originally designed shape. The Star Class has gone a step further here, by calculating the correct station points for each mould in existence instead of a generic set to fit all as in the FD.

H.2.8 Tornado Class hull measurement system

The Tornado Class is using a unique system to set up the hull and applies the following procedure:

Measurement of the Tornado hull requires the application of templates at a number of stations along a hull. Station 0 and station 5 meters are required to be established initially in relation to a horizontal base line and relative to each other. Then stations at 1, 2, 3.3 and 4.2 meters can be located in the correct places.

When applying the templates the hull must be positioned so that the base line is level. Stations are to be located by measurement along the base line and transferring the position to the keel by either a plumb line or spirit level.

To locate the correct position of the bow template the inscribed base line on the bow template must be aligned with the 5 meter station template base line hole. This requires movement of both templates along the keel centreline and bow centreline until the base line is correctly positioned. Only then is the zero station located correctly, and the sheer at the bow be checked. The stem head datum may not necessarily be the forward most portion of the bow. A water tube, spirit level or laser level may be used to level the base line datum.

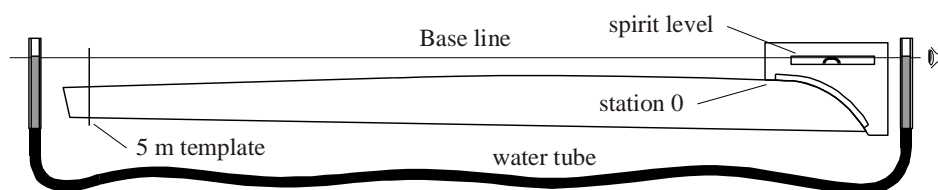

For checking measurements at events, the stations can be located by using a tape along the keel from the “0” station, which allows location of stations without the extra time required to level the hull. The error is slight. If a tolerance question arises, then the template must be located more accurately and the base line datum levelled.

Each of the templates is positioned at stations 0, 1, 2, 3.3, 4.2 and 5 meters aft of the aft edge of the bow template. Each of the templates shall touch the hull at, either the centreline inscribed on the template, or within the raised section on the template, and on both sides of the inscribed centreline.

The following diagrams depict the limits and measurement points when applying the hull templates.

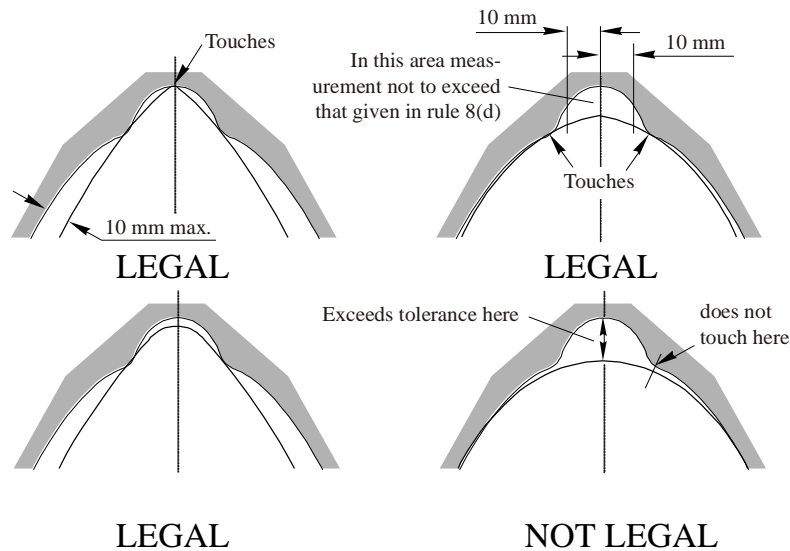

The base line shall pass through the holes in the templates and shall clear the templates at 1, 2, 3.3 and 4.2 meters. If the measurer can sight through all the templates, from aft of the station 5 meter template to the bow template at the same time, then the base line is within tolerance.

The sheerlines at all stations shall not be above or below the tolerance marks on the templates. The radius at the sheer measured perpendicular to both the deck and the topside shall not exceed 12 mm. The sheerline is located using the standard practice of projecting the line of the deck and outer topside. The deck template is long enough to be used for projecting the deck line and a straight edge may be used on the outer topside. The following diagram illustrates this.

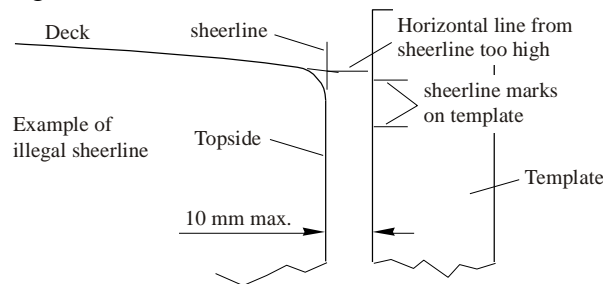

Many boats have a radius on the sheer; 12 mm is the maximum radius allowed as in the following illustration. The 5 mm deck tolerance and the 10 mm hull tolerance do not apply above the bottom of the sheer radius.

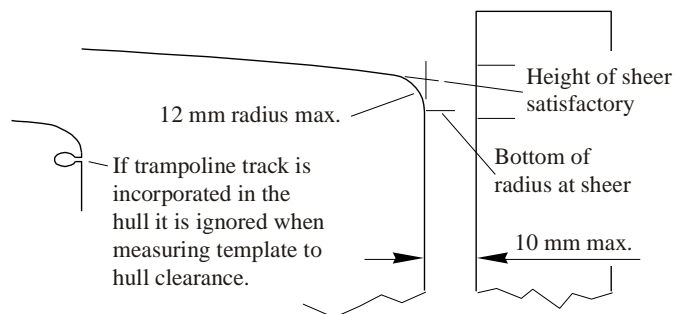

The aft surface of the transom at the sheerline level shall be not more than 50 mm and not less than 30 mm forward of the aft most point of the hull. The rake of the transom must be measured from a plumb line or vertical spirit level when the hull is set up with the base line datum level. Using a square off the deck or the keel will give an error.

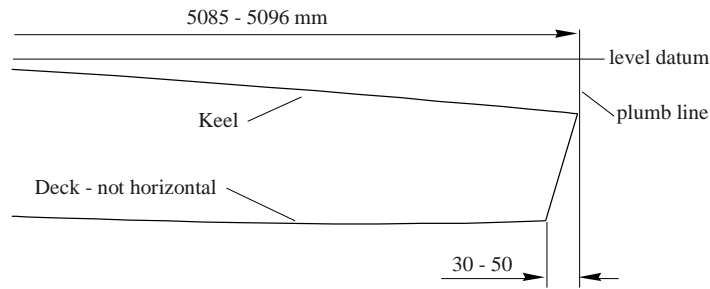

H.2.9 Hull measurement of a “chine” hull: Case study for the Lightning Class.

The Lightning Class hull measurement is explained below, using a string baseline system, and a HDP that is not at the transom corner.

H.2.9.1 Hull setup

The hull is placed upside down on three supports with a hydraulic jack on a level floor as the third support near the front of the bow. Fixed supports may be used if enough manpower is available for leveling the bow.

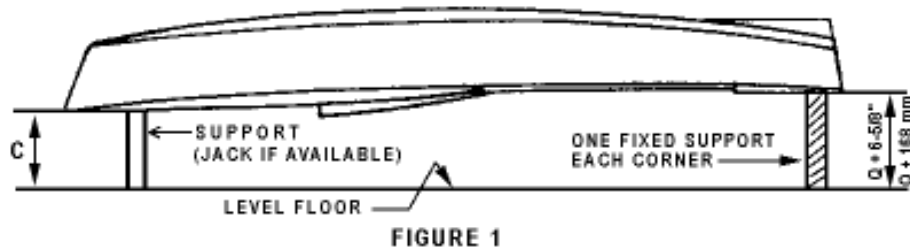

Measurer has to see that each corner of the chines or sheer at transom is the same height from the floor. The hull is then adjust so that the deck at the stem is 168 mm lower than centreline of deck at transom. A carpenter’s square with leading edge to centreboard pin as per figure 2 is used to locate point A.

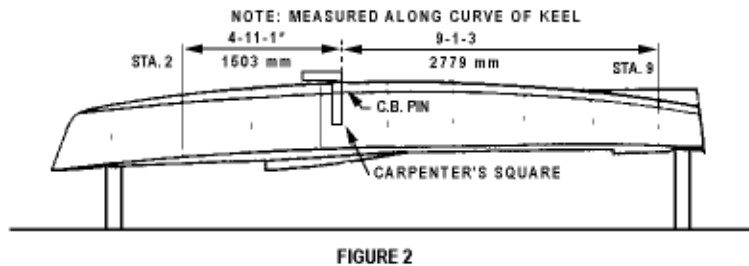

After point A is located, measure along the curve of the keel 1503 mm and mark approximate location of station 2. Then measure aft along the curve of the keel 2779 mm and mark the approximate location of Station 9. Before erecting the baseline the amount that the keel stands proud of the bottom must be taken into consideration per figure 3.

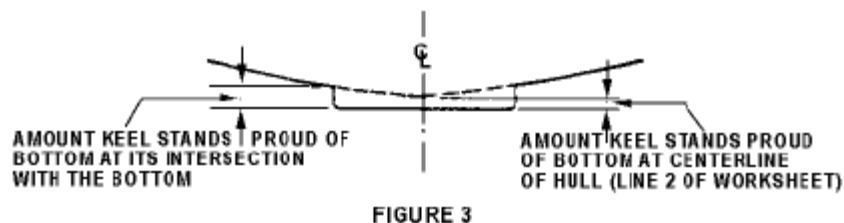

This amount may vary from station to station depending on keel width and the relationship between chine height and breadth and centreline height. The important point is to measure from the base line to a point at which the outside bottom would intersect the centreline without the keel.

The exact distance from baseline to keel plank for the establishment of the baseline is obtained by subtracting line 2 from line 3 on the worksheet for stations 2 and 9. This is the figure recorded on line 1 of the worksheet.

For maximum speed and accuracy in establishing the baseline it is suggested the baseline be supported from the hull itself. It may however be supported from separate posts securely attached to the floor at each end of the boat.

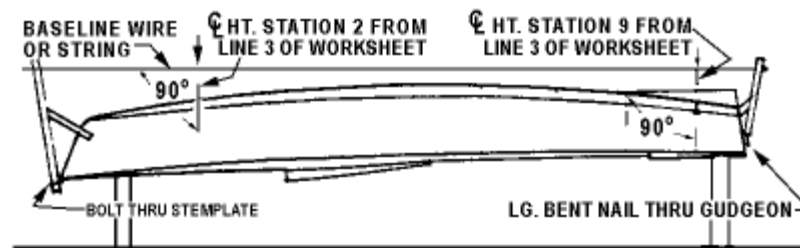

FIGURE 4

For measuring heights choose a scale or steel ruler so that, by turning it end for end, you can always measure directly from keel plank to baseline.

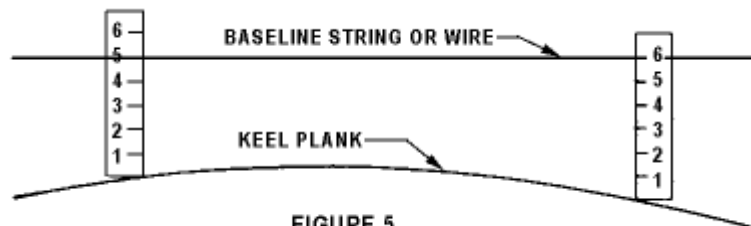

FIGURE 5

For accuracy always hold the scale beyond the baseline and place the eye of baseline height so that wire will pass directly in front of the measurement to be taken. If possible use 1.5 mm piano wire stretched as tight as practicable and free from kinks. Extreme caution must be used to minimise sag.

Jockey baseline so that the perpendicular distance from baseline to top of keel at stations 2 and 9 agree with the figures placed on line of the worksheet for those stations.

H.2.9.2 Levelling and measurement of hull

Recheck location of point A on keel with the carpenters square, and if necessary relocate stations 2 and 9, and recheck baseline for levelling. It is imperative that the baseline is level.

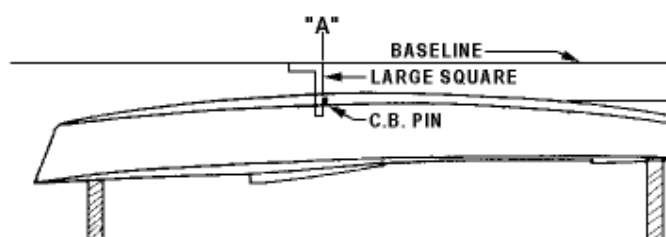

FIGURE 6

Stations

Locate and mark from point A to stations

- 1 forward 2118 mm
- 3 forward 888 mm
- 4 forward 276 mm
- 5 aft 330 mm
- 6 aft 940 mm
- 7 aft 1553 mm
- 8 aft 2159 mm

Measure the vertical distance from baseline to keel plank at all stations (except 2 and 9) and record on line 1 of the worksheet.

Lengths

Using a plumb bob, mark the following horizontal locations on the baseline per figure 7
Stem at deck

Intersection of W and X

Intersection of transom and fairbody (bottom)

Intersection of transom and deck

Paper clips are useful in marking locations on the baseline. To find the intersection of W and X, hold the plumb bob on a string against a vertical scale until the point stands exactly 457 mm below the fingers. Then hold the string against the baseline with the fingers just touching the baseline. Move the bob along the string horizontally until the point of the bob just touches the stem.

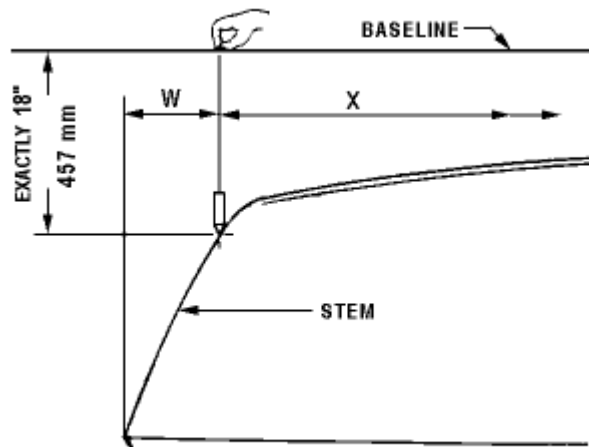
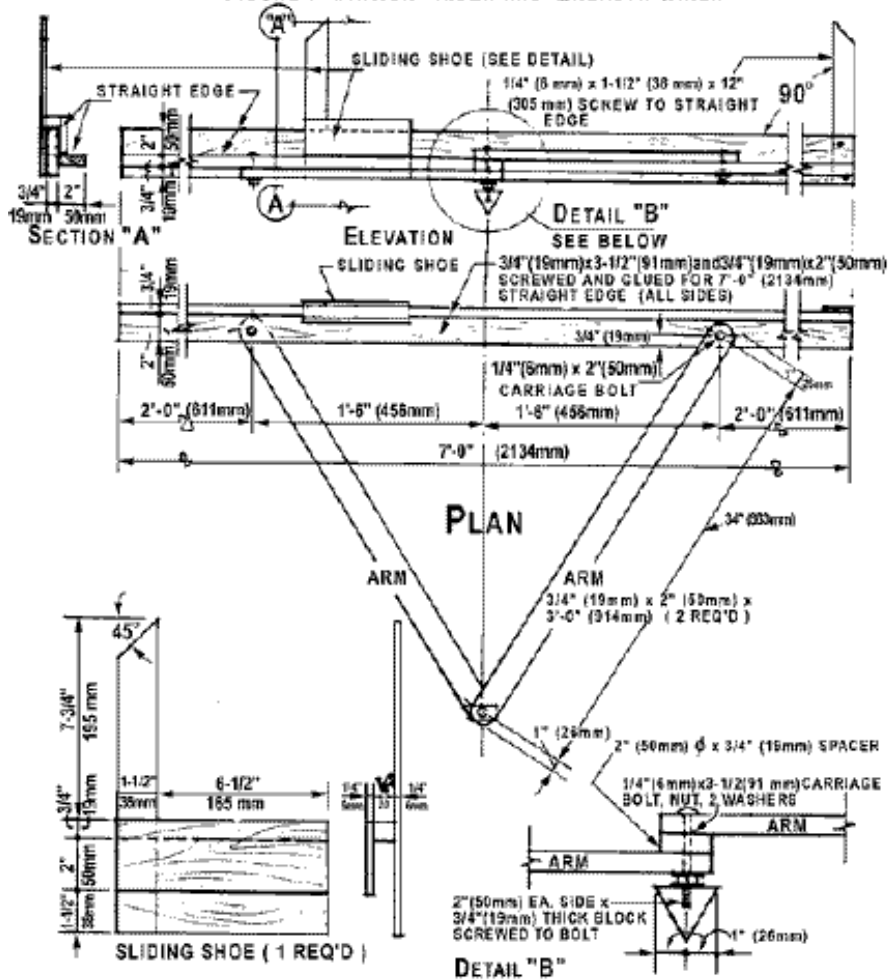

FIGURE 7

Chine and sheer heights

The use of a combined "station finder" and "breadth taker" as illustrated below will simplify the measurement of chine and sheer heights and breadths.

FIGURE 8 STATION FINDER AND BREADTH TAKER



INTERNATIONAL LIGHTNING CLASS ASSOCIATION
INSTRUCTIONS TO MEASURERS FIGURES 1-11
REVISED BY SALES & SERVICE 1/84

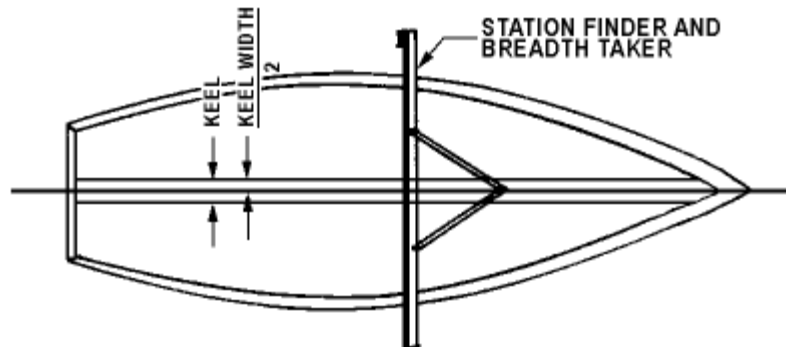

FIGURE 9

Place a "Station Finder" with its centreline progressively on the centreline of the keel at each station. At station 1 use a straight ruler by eye. At station 2 through 7 the arms of the station finder must be downhill. At station 9 the station finder should be on top of the skeg with arms forward. Place pin of station finder on centreline of keel.

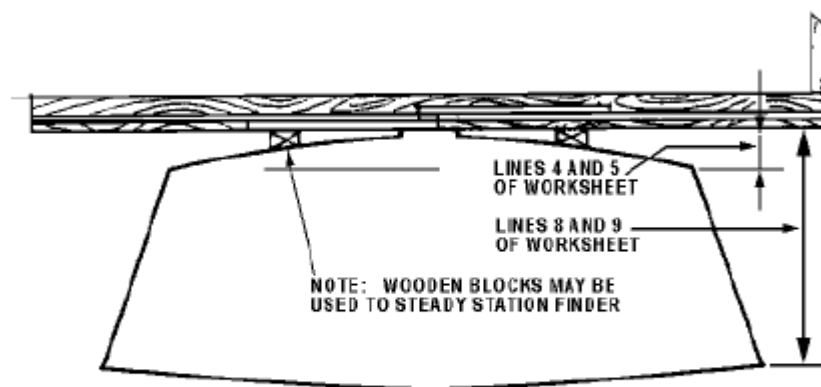

FIGURE 10

With station finder located per figure 10, use a plumb bob to mark each station on the chine and sheer, both sides of boat.

With the station finder in position at the stations, measure and record on the worksheet in lines 4 and 5 the perpendicular distance from station finder to chine on each side of the boat. Repeat for sheer entering figures in lines 8 and 9. At station 9 subtract the height of station finder above height of skeg at this point.

Using line drawn across transom below from chine to chine measure directly vertical distance from this line to baseline and record under T in line 7 of the worksheet.

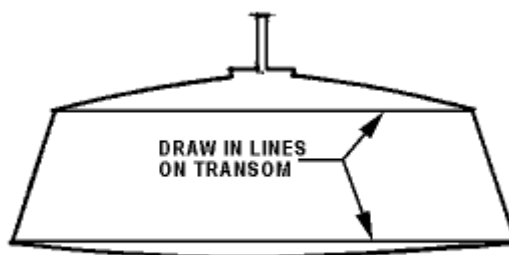

FIGURE 11

Repeat the process by using line on transom from sheer to sheer and record on line 11 of the worksheet. Measure sheer height at 0 directly perpendicular to baseline at point marked in D1.

Chine and sheer half breadths

Place the sliding shoe on the station finder so that it becomes a breadth taker. Place the pointers simultaneously at both chines for each station progressively. Squeeze the shoe firmly to the straight edge, then measure the distance between pointers and record on line 12 of the worksheet.

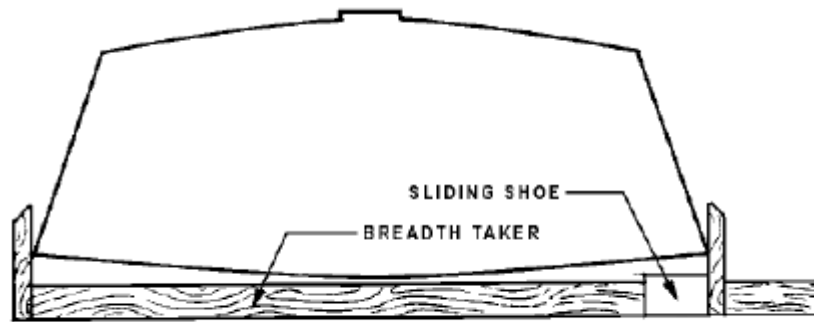

FIGURE 12

Repeat at all stations, then measure breadth and T directly across transom.

Repeat at sheer recording in line 14 of the worksheet. If rub rails are in place be sure to subtract both. Note: If the chine is rounded special precautions must be taken in measuring. To find the exact intersection of bottom and topsides use a corner finder below.

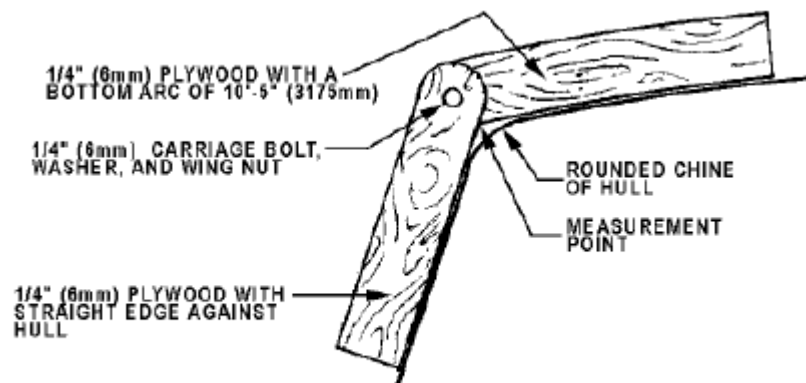

FIGURE 13

Interpreting the worksheet

- Centreline Height - Add line 1 plus line 2 and record on line 3. Line 3 is the centreline height and may be transferred to the Certificate.
- Chine Height - Add line 4 plus line 5 and divide the sum by two and enter on line 6 to get the average port and starboard chine height above the keel. Add line 6 plus line 1 and enter the sum in line 7. Line 7 is chine height and may be transferred to the Certificate.
- Sheer Height - Add line 8 plus line 9 and divide by two and enter in line 10 to get the average port and starboard sheer height above the keel. Add line 10 plus line 1 and enter the sum in line 11. Line 11 is sheer height and may be transferred to the Certificate.
- Chine Half Breadth - Divide line 12 by two and enter the result in line 13. Line 13 is chine half breadth and may be transferred to the Certificate.
- Sheer Half Breadth - Divide line 14 by two and enter the result in line 15. Line 15 is the sheer half breadth and may be transferred to the Certificate.

Keep your worksheet until all figures have been approved.

Other measurements

Measure and record on the Certificate keel widths as required.

Measure along the bottom edge of the skeg from the after end to the intersection of the skeg with the keel, and record on the Certificate. Measure the thickness of the skeg, checking to see that the skeg has parallel sides and does not taper and record on the Certificate. Measure the height of the skeg from its aftermost bottom edge along the after edge of the keel and add the amount the keel stands proud of the bottom at the centreline from line 2 of the worksheet and record on the Certificate.

Check and record hull thickness wherever visible.

Measure the bottom of the keel to the bottom of the edge of the centreboard pin and record on the Certificate.

Check the diameter of the centreboard pin and check to see that no bushings are present - diameter of pin is 15.875 mm (5/8").

Measure the width of the centreboard slot through the keel and record on the Certificate. Verify that the slot and space is uniform throughout.

Check the bottom arcs.

Two templates should be used of metal, plastic, press-wood, or 6.5 mm plywood 1 meter long as per figure 14.

The 2438 mm arc should be first slid over the bottom holding it perpendicular to the centerline. This arc should touch the hull at the keel and at the chine simultaneously for the entire length of the boat. If it does not touch, the arc is less than the minimum 2438 mm. The 4572 mm arc should likewise be slid over the bottom in the same manner. This arc should never touch the hull at the chine and keel at the same time. If it does the arc is greater than 4572 mm. However, the Measurer should use judgment as to whether the arcs don't measure because of small areas of bumps or pockets.

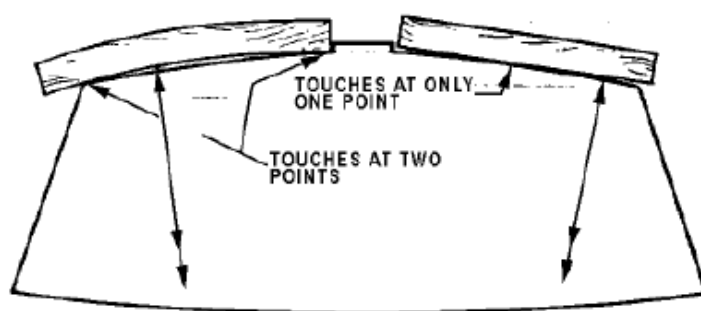
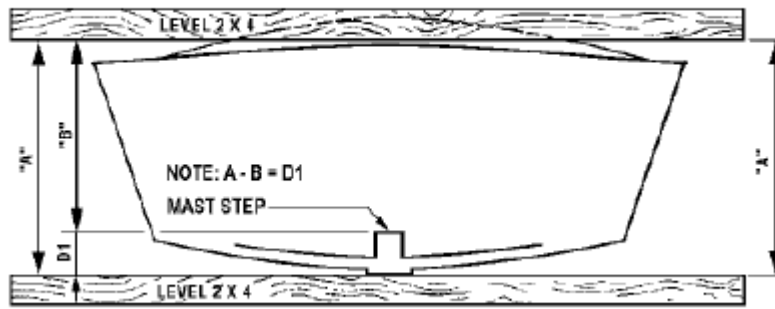
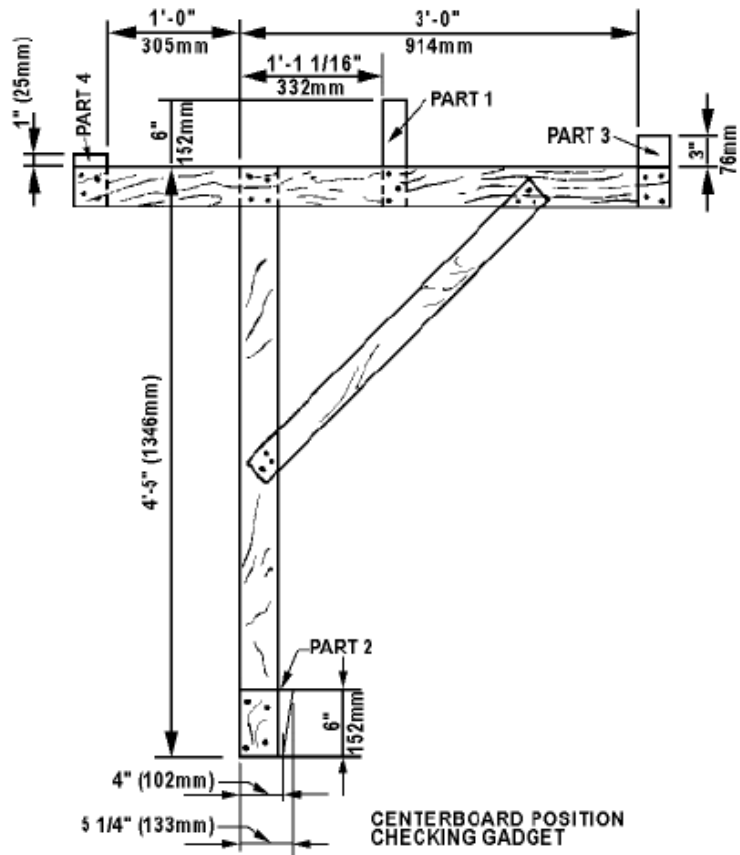

FIGURE 14

If the hull passes both of the arc tests, record "yes" in the box. D1 measurement is done as below



FIGURE



Angle of Dangle Device

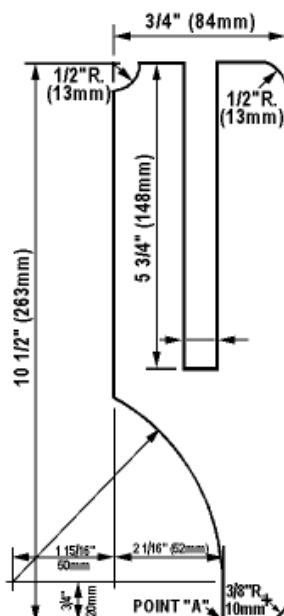

Centreboard Thickness Measuring Device

H.3 Hull Weight

The class rules lay down the condition in which the boat is to be weighed and what equipment has to be on board, and what is excluded. Under ERS, there is a clear separation between **hull weight** and **boat weight**.

H.3.1 Hull weighing conditions

In all cases the boat must be dry and there must be no water in the boat or in the buoyancy compartments. Likewise there must be nothing on board that is not required, or permitted to be included in the weight.

Wind can affect the recorded value of weight. Even though the scale may be registering a steady weight there may be a steady up thrust or down thrust due to wind. It is therefore important that the boat be sheltered from the wind while it is being weighed.

The weighing machine has to have adequate capacity and preferably should be operating within about the range of one-half to three-quarters of its capacity.

The weighing machine should preferably be calibrated before use with a calibration weight similar in weight to the expected weight of the boat. Regular calibration is particularly important for electronic scales and load cells. Wear in mechanical weighing machines affects their accuracy and any error needs to be known.



The measurers should be careful to avoid a zero error. The weight of the slings is not normally included in the weight; therefore the reading of the scale with only the slings on it should be noted and deducted from the reading obtained with the boat on it. This procedure automatically takes account of any zero error in the instrument.

Dinghies are normally weighted with an electronic platform scale, a spring scale or a steelyard. Some of these require the scale to be suspended from a suitable fixed point and the boat hung from a scale. The scale needs to be low down since headroom may be limited -and in any case so that the scale can be read or adjusted easily. If the centreboard is out of its case the boat can be supported by passing a rope through the case and inserting a short bar underneath the hull. Lines can then be used to stabilize the boat fore and aft and athwartships, usually attached to fittings.

Keel boats normally require a crane or gantry to pick up the scale and the boat. Most keel boats have lifting eyes in the hull and the owner has his own slings for launching and recovery by crane. In any case the owner or his representative should be told that he is responsible for the arrangements for suspending the boat.

H.3.2 Underweight boats and weight correctors

Class rules lay down minimum hull weights (and in some cases maximum weights as well) and it is normal for builders and owners to attempt to keep the weight of the boat to the minimum. Boats which are below the minimum weight are required to have the weight brought up to the minimum by having weight correctors fixed in the hull. The class rules lay down the location of these. It is normal for these correctors to be of lead, but whatever material they may be made of they have to be properly fixed in the hull, in positions specified by the Class rules. This weight, and in some cases position, normally has to be entered on the measurement form and this information will appear on the measurement certificate.

In most of the classes removal or alteration of weight correctors renders the measurement certificate invalid and the boat then has to be officially re-weighed by a measurer and a new measurement certificate obtained.

Some classes have a maximum limit on the weight of correctors permitted. If the weight required to bring the hull weight up to minimum exceeds the maximum corrector weight permitted, then the measurer should not sign the measurement form until the owner or builder has rectified the problem within the constraints of the class rules.

H.3.3 Weighing at Major Events

The quality of weighing results depends on:

- the equipment,
- the conditions,
- the qualifications of operators.

Hull weighing should be performed using Class III scales, with a display step of 1/3000 or 1/6000 of their measuring span (i.e. 50 grams for a 150 Kg scale). Usability in legal metrology and legal trade provides, in general, a guarantee for the obtained reading under ideal conditions. If the scales are not verifiable for legal metrology, credibility is provided by a valid calibration certificate. Span adjustment, which is sometimes also referred to as calibration, is not sufficient. Weighing within the first 50 display steps is also prohibited by legislation. If it is still necessary to weigh small objects, it is

recommended to place a larger object on the scales, tare the weight of this object (zero weight appears on the display) and then determine the weight of the small object (unfortunately it may be inaccurate due to the large step value).

- Platform scales are easier to use but need a protective pad or a cradle to set the boat on top.
- Hanging scales need slings and more people to lift the hulls: they may also take more time to settle for taking the readings.

The weighing station should meet the following requirements:

- - Change in the temperature of the environment should be minimized
- - Direct sunlight to the scales must be avoided
- - There should be no vibration or strong draught
- - Scales must be on a stable base and levelled (floor scales)

A check in accordance with the scales manual is recommendable before official weighing. The verification or calibration marking of the scales must be clearly legible and the verification or calibration date (period) valid. If no documents are available, then the following tests help to establish the suitability of the scales:

- 1) Place a load in the centre of the platform (20% of max. load) and tare the scales reading. When you now weigh the load on the corners of the scales and the difference with the tarred quantity does not exceed one step, things look good.
- 2) Sensitivity test: Put a load of about 50 display steps on the scale. When a weight equalling the value of one step is added, the reading must change by one step.
- 3) Deviation of readings: Repeatedly place the same load on the scales. The reading should not change. A few occurrences of a 1 step change in the same direction are acceptable. The scale reading should be the same on unloading as for loading, i.e. no hysteresis.
- 4) For multi-pad scales, such as used for catamarans the reading should be the same as each pad is loaded, and subsequently the reading should be the sum of the pad loadings.

It is certainly necessary to carry out a span adjustment during which the scales are “told” the value of gravity acceleration at the place where the weighing takes place. Electronic scales measure the force applied to them and the mass that we are interested in is calculated with the formula $M = F/g$. In this formula g is the local gravity acceleration value, which takes into account the latitude, the altitude from the sea level, geological conditions, etc. In practice a good indicator of the conditions is the stabilizing of the scales reading. If the reading of proper class III scales has problems stabilizing, there are problems with the conditions, the weighing results are unreliable (due to the conditions) and reading should not be used. A typical example is the weighing of keelboats outside in the wind. If a stable reading cannot be obtained, you should find suitable conditions or a place with less wind. Nobody has the right to force a measurer to breach professional ethics.

A measurer cannot be at all measurement stations at the same time. Although scales develop towards the simplification of procedures, a certain problem is often presented by the training of assisting persons. It must be taken into account that this takes quite a lot of

time. Once a stable reading has been reached, a new character appears. The rules usually provide the weight of the boat together with certain equipment in dry condition. A boat meets these conditions when brand new. A dry boat that has been sailed is heavier than a new dry boat etc. Damp control lines are surprisingly heavy and some competitors dampen them on purpose. There is no point in weighing a boat that has been out in the rain prior to weighing! A “Finn” that has sailed today is up to 1.5 kg overweight even after two days.

Almost each boat class has an official procedure for weight correction. In practice this situation can be avoided only by the class measurement consistency and educating of the yachtsmen. The majority of yachtsmen violate the rules because they are not familiar with the rules. Indeed we should start from teaching. A measurer is also a teacher: Everybody must be treated equally, each case is a new one and old sins do not count!

In case of wet boats at an event:

- If it is hot and sunny, the crew must dry the boat and come again.
- If the weather is wet, it might be possible to compensate for the extra weight, based on each boat’s actual condition.

In case of bad weather at events, it is better NOT to check equipment weight at all.

H.4 Weight Distribution

It is well known to most sailors that the speed of their boat is adversely affected by excess weight. Heavy boats accelerate more slowly and have greater resistance, as the hull floats lower in the water. The depth of the average position of the mass, i.e. the centre of gravity (CG), below the centre of buoyancy affects the righting moment and hence the ability to carry sail. Thus many classes have rules controlling the minimum weight and height of the CG. The fore and aft position of the CG is also important so that the hull sails on its lines, and so it can surf easily and does not dig the bow into waves. Many sailors, especially in dinghies, like to have the CG as far aft as possible for these reasons, and because the addition of the crew generally moves the total CG aft.

The degree of concentration of the weight in the boat is described by its radius of gyration. A boat which has light ends has a smaller radius of gyration than one with heavy ends. However, the effect of the distribution of the weight about the CG, which is what a swing test measures, is a little more sophisticated. If we consider the weight as if it was equally divided at the ends of a dumbbell, then it will always balance at its centre, i.e. the CG. However, as the length of the dumbbell is increased it becomes more difficult to start or stop it turning. Pitching is a rotational motion, and the more of the weight that is in the ends of a boat the lower the frequency at which it will naturally pitch. This affects the pitching response in waves, and hence to some extent the boat speed.

The advantages of swing testing are that it eliminates separate controls of the hull and keel weights and CG positions, which can only be checked during manufacture. If the radius of gyration is controlled, then it is normally not necessary for the class rules to control the construction scantlings. If carefully designed, swing testing can be performed at major regattas in conjunction with other measurements. This is the case in the Finn class which swing tests entrants to the Gold Cup. The disadvantages are that the procedure is a dynamic measurement, and is often not understood by the competitors. Swing testing also requires rigid supports and an enclosed space free of draughts.

Essentially all classes have a minimum weight restriction and some like the Etchells also have a maximum weight rule. If a class wishes to further control the weight distribution than a control of the position of the centre of gravity CG or balance point should be the next step, as this can be controlled by static measurements. The Yngling class requires that “The position of the centre of gravity of the hull and deck in the condition specified above shall not be lower than that at which the hull would balance on its side when heeled to 110 degrees” which requires that the hull is balanced on the sheer and must fall to the deck side as shown in figure H.4.1.

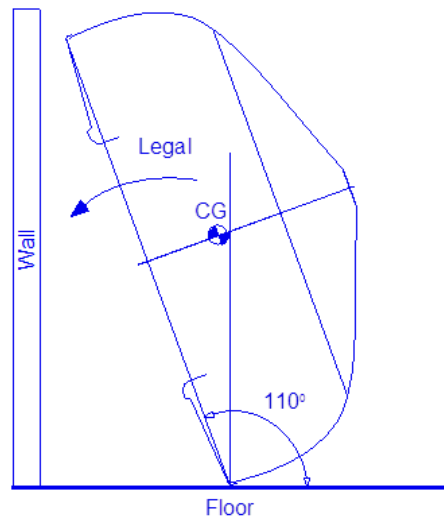

Figure H.4.1 Yngling balance test for the vertical position of the hull and deck.

The fore and aft position of the CG can be determined by freely suspending the hull, adjusting it until it is level and dropping a plumb bob from the point of suspension. For dinghies a simple go-no-go test is illustrated in figure H.4.2, The hull is placed on an athwartships pivot a specified distance forward of the HDP, levelled and then released (with a matt on the floor to cushion the impact). If the hull is legal with the CG forward of the axis, it will tilt forward.

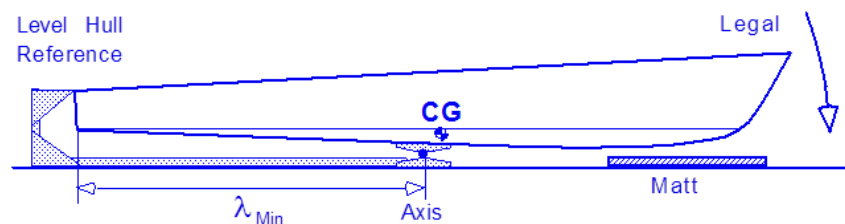

Figure H.4.2 Test to establish that the CG is forward of λ_{Min} .

Only if a class still feels that a more sophisticated control of weight distribution is necessary is a swing test suggested.

H.4.1 The “Lamboley” Swing Test

In the 1960s fibreglass construction was replacing wood and many class technical committees were considering new rules to ensure that old boats remained competitive and that the construction of new boats was sound. Clearly the hull weight would remain the same, but the new construction allowed much more flexibility as to its location. Not only could the centre of gravity be changed but also the ends could be made much lighter, and concomitantly more fragile. A number of classes introduced swing tests in order to control these tendencies. The best known was introduced in the Finn class by Gilbert Lamboley, and is known as the “Lamboley test”. However many other classes also introduced swing tests at various times and these include the Europe, Snipe, Star and

Dragon, while others such as the 470 (Pusan and Barcelona), 49er (Sydney) and Yngling (Athens) required swing tests for Olympic regattas. Many other classes including the FD, Lightning, Fireball, Int.14, OK Dinghy, Comet, Vaurien, Tornado, Lechner and Soling as well as the IMS rule and even an R/C class have investigated swinging but eventually decided that it was not required.

For static measurements or linear motion Newton's law that $F = Ma$ describes the motion, where the net force "F" produces an acceleration "a" of the body of mass "M", and this is independent of the weight distribution. When weighing a boat the acceleration is zero so the two upward forces just balance the weight Mg , as shown in figure H.4.1.1 for the simple case of a hull with its centre of gravity exactly in the centre. It is a common misconception that by placing a knife edge at the bow and a scale at the stern one can determine if the stern is heavy and vice versa, but this is not correct. Both the hull with all the weight all at the CG and the hull with the same CG but the weight spread out will produce the same scale readings. In fact there is no way that static measurements on the hull will allow one to measure the weight distribution.

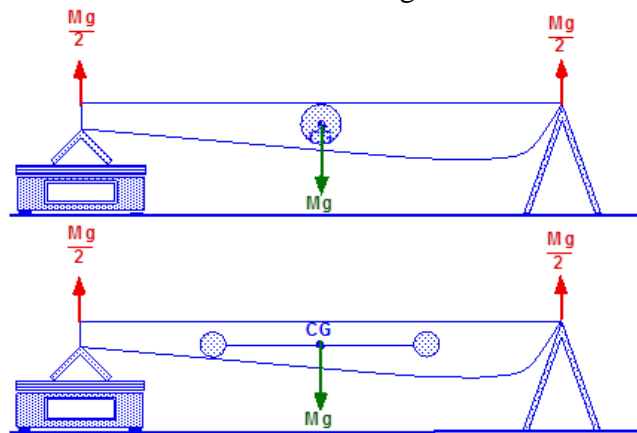

Figure H.4.1.1 Weighing the ends of a hull will NOT reveal light or heavy ends.

However, for rotational motion Newton's law becomes $\Gamma = I\alpha$, where Γ is the torque or twisting effect of the forces, $I = Mp^2$ is the moment of inertia about the axis of rotation and α is the angular acceleration produced. The moment of inertia is the sum of the individual masses times the square of their distances from the axis of rotation and equals $M\rho^2$ where ρ is the radius of gyration or gyradius.

$$I = \sum_i m_i r_i^2 = \rho^2 \sum_i m_i = M \rho^2$$

This clearly depends on both the direction and location of the axis of rotation and "I" is in fact a 3 x 3 tensor. However sailors are most interested in pitching motion which is a rotation about a horizontal athwartships axis and so this is our primary concern, although some measurement techniques measure about the vertical yaw axis and so are not quite comparable. A simple way of visualizing the radius of gyration is to imagine the hull as a dumbbell with two masses $M/2$ which will balance in the middle, i.e. the CG, and with each mass at the radius of gyration from the CG as shown in figure H.4.1.2, which also shows how the placement of equipment will affect the radius of gyration. Placing mass at the radius of gyration from the CG will not change it, while adding weight closer to the CG, or removing it further from the CG will decrease the radius of gyration.

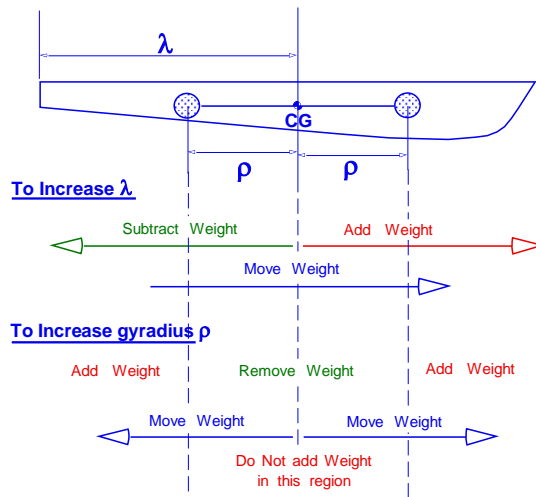

Figure H.4.1.2 For pitching the hull can be considered as a dumbbell with two equal masses the radius of gyration forward and aft of the CG.

In order to measure the moment of inertia or radius of gyration one requires some form of rotational motion for which one needs to know the torque and the angular acceleration it produces, i.e. $I = \Gamma/\alpha$ and a pendulum is a simple system where the weight produces the torque and the angular acceleration can be deduced from the period of oscillation T . Unfortunately the lever arm, i.e. the distance “a” from the axis of rotation to the CG, where the weight Mg can be considered to act, also comes into the equation for the torque and hence the period and thus there are two unknowns.

$$T_1 = 2\pi \sqrt{\frac{a^2 + \rho^2}{ag}}$$

Gilbert Lamboley solved this problem by making a second measurement of the period T_2 with the axis moved by a known distance “b”, which he chose to be 200.0 mm. Then

$$T_2 = 2\pi \sqrt{\frac{(a-b)^2 + \rho^2}{(a-b)g}}$$

These two equations can be solved and the centre of gravity position “a” and the radius of gyration “ ρ ” and can be found using a calculator or spreadsheet and the following equations

$$a = \frac{b(gT_2^2 + 4\pi^2 b)}{g(T_2^2 - T_1^2) + 8\pi^2 b}$$

Axis to CG

$$\rho = \sqrt{a \left(\frac{gT_1^2}{4\pi^2} - a \right)}$$

Radius of gyration

Or, by using the following weight distribution graph:

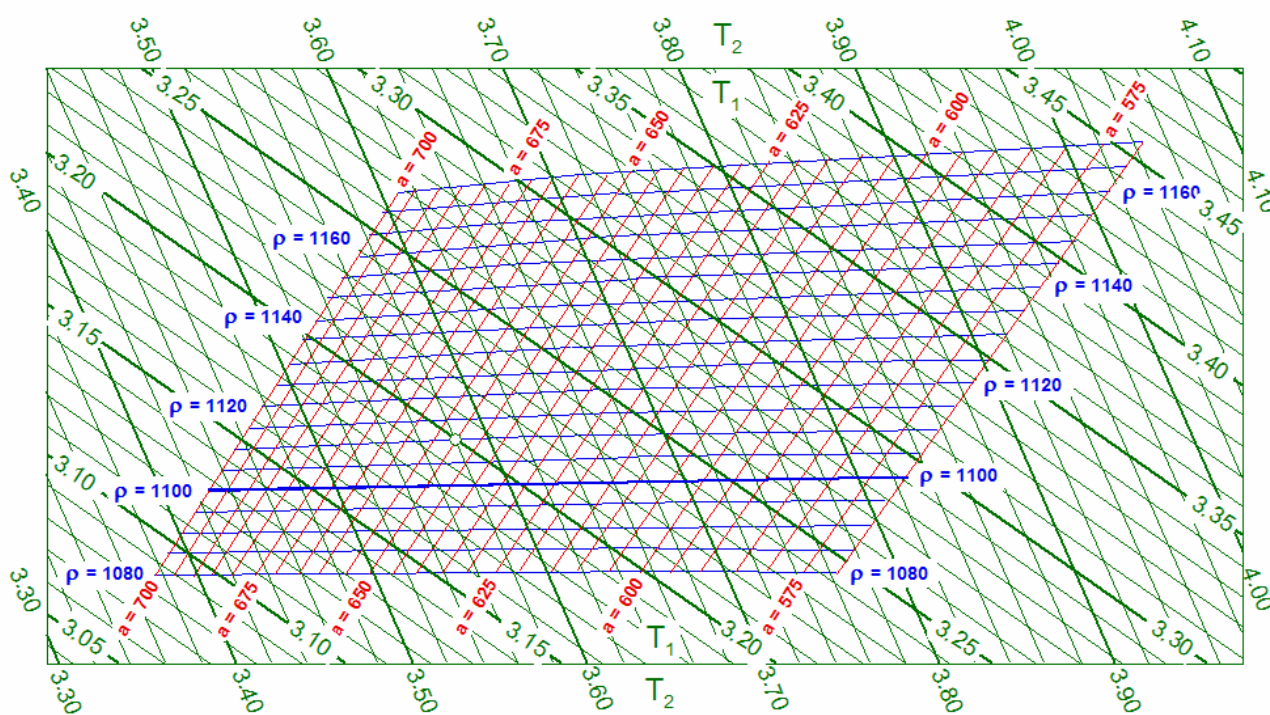

Figure H.4.1.3 The Finn graph introduced by Gilbert Lamboley for determining “a” and “p” from the periods T_1 and T_2 , given that $b = 200.0$ mm.



Figure H.4.1.4 An FD undergoing a Lamboley test at the 1976 Olympics, as demonstrated to Queen Elizabeth.

H.4.2 Weight Distribution and Centre of Gravity: Practice

The modern equipment used to carry out a Lamboley swing test is shown in Figures H.4.2.1 and H.4.2.2 (weighing scale not needed for the test itself).



Figure H.4.2.1 A modern Finn Lamboley system showing the pairs of retractable knife edges, the Finn hooks with bearings 200 mm apart and the photocell used for timing.

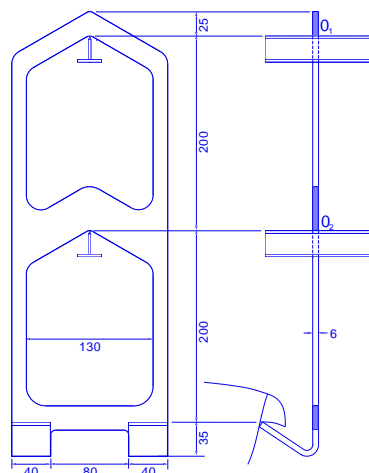

Material: 6 mm Mild Steel
Mass (2 hooks): 2.70 kg min, 3.30 kg max.
The distance $O_1 O_2$ shall be correct to within 1 mm

Figure H.4.2.2 The 2009 Finn Class hooks with bearings 200 mm apart, which ISAF recommends as a standard for use by all classes.

Prior to a swing test the hull should have been weighed, the position of any corrector weights recorded and the hull inspected to ensure it is dry, in the condition specified in the class rules and that there are no loose fittings which can move during the swinging.

The hull is suspended by using hooks inserted under the sheer guards and must rest on the hooks with no relative motion. These are hooked so that the boat is level fore aft (i.e. the hooks coincide with the fore and aft position of the centre of gravity). Care needs to

be exercised to ensure that the hooks are engaged properly - otherwise the boat may fall! (A mattress should be placed under the boat as a precaution). The hooks should be aligned to be vertical (otherwise “b” is not the nominal 200 mm) and the bearing surfaces of the soft iron hooks inspected from time to time and filed if seen to be grooved. The knife edges, on which the hooks swing, are mounted on cylinders sliding through supports on each side, so they can be retracted for rapid change of axis without lowering the hull, but are clamped rigidly so they do not move when in place. The axes of swing should be adjusted to be horizontal.

A pointer - a piece of light plastic is most suitable - is attached to the stem by masking tape and a reference point erected adjacent to this when it is in the stationary position. The hull is oscillated through a fairly small angle – the Finn class specifies less than 200mm total movement of the stem head, and the period of oscillation taken. The time for 10 complete oscillations is measured (after the boat has completed a few oscillations to enable it to settle down) and the time for one oscillation calculated and noted. For other classes, the starting amplitude and number of oscillations to record are sometimes defined in the class rules.

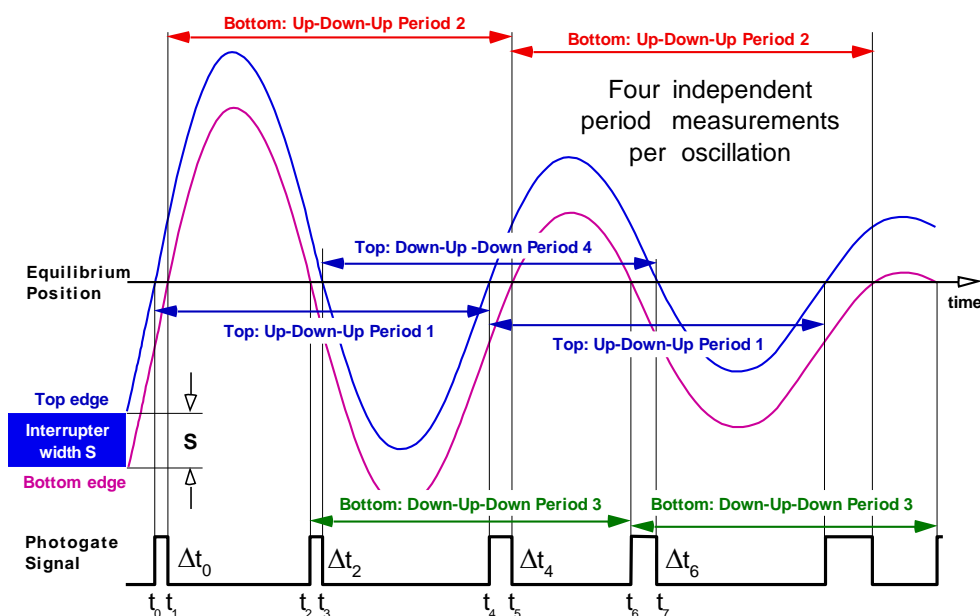

Figure H.4.2.3 The photo-gate timing with an interrupter of width S aligned so the top edge is at the stationary position. The amplitude decay is exaggerated for clarity, and shows that the periods two and three recorded from the bottom edge are not perfectly accurate. The amplitude can be deduced from the interruption intervals Δt .

The greatest accuracy is achieved if the stop watch is started and stopped as the pointer passes the reference point while it is moving fastest. If the reference point is not at the equilibrium position of the swing the damping of the motion leads to error as shown in figure H.4.2.3. Record the time for 10 complete oscillations to 1/10th of a second, and then calculate the period to 1/100 of a second. The procedure is repeated for the second pivot position and the radius of gyration calculated with a calculator, graph or simple computer program.

Electronic timers connected with a photocell trigger give the best results, eliminating start/stop errors by the measurer and therefore enabling results to be calculated from fewer oscillations. The period of individual oscillations can be read out, and several consecutive oscillations can be checked for consistency. For Equipment Inspection of many hulls at the start of a Regatta, electronic timing is essential. Connecting the photo-

gate directly to a laptop, which records the successive periods, avoids transcription errors (easy to make during regatta inspection of many hulls!) and also allows one to see inconsistencies, due for instance to the presence of free water in the hull.

It is essential that the measurements be made in a sheltered place. The Finn class specifies that hull shall be hung from the brackets on axis O_1 , O_2 and the periods of oscillation T_1 and T_2 measured. Plot the position with co-ordinates T_1 , T_2 on the graph, and read off the values for "a" and " ρ " from the curves. The distance " λ " is measured parallel to base line from Station 0 to axis O_1 . If " λ " is found close to limit value make sure that base line is level as in figure H.4.2.4.

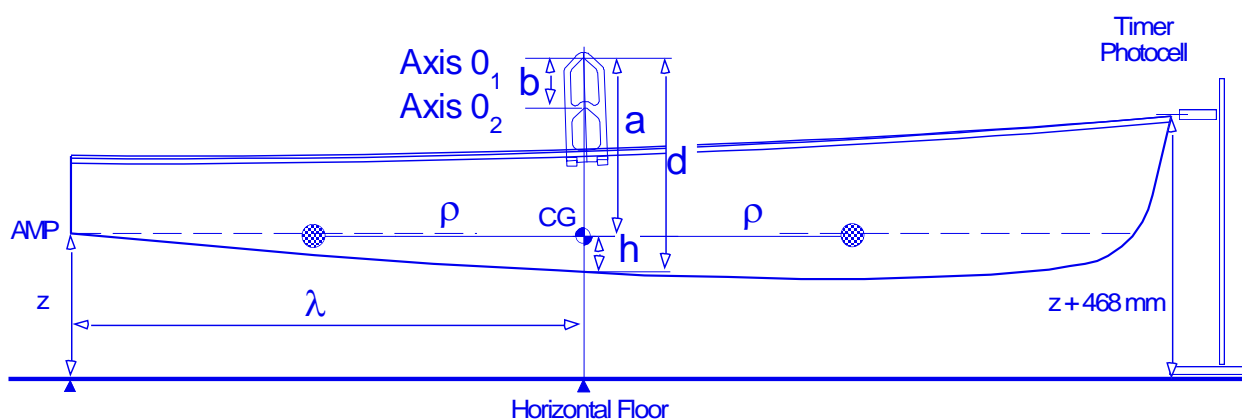

Figure H.4.2.4 The Finn Class Lamboley test. The periods of oscillation T_1 and T_2 about axes O_1 and O_2 are measured, and then the CG position "a" and radius of gyration ρ are calculated. Measurements of " λ " and " d " determine " h ", the position of the CG in the hull.

Distance "d" can usually be measured from axis O_1 to the underneath of the hull (excluding keel band) by means of a rule or tape passed down through the centreboard box, or by means of a horizontal laser beam attached to the stand. It is wise to provide a protection under the boat but the boat shall not touch anything while oscillating. The oscillations shall be small, but should not become significantly damped in less than about 100 periods. There shall be no twisting oscillations about a vertical axis. There shall be no movement of the supports.

H.4.2.1 Errors and their reduction

Errors can be introduced by

Timer calibration. Most electronic timers are quite accurate, but it is good practice to calibrate them against a certified time signal such as www.time.gov, before relying on them for critical measurements. In principle the local value of g should also be used as well as a correction for buoyancy.

Incorrect hooks. The hooks swing with the hull so it is in fact the moment of inertia of the hull plus hooks which is measured. Overweight hooks or hooks of the wrong geometry (do not use Europe hooks for Finns or vice versa) lead to erroneous results.

Incorrect amplitude. Contrary to the elementary theory, the amplitude of the swing can significantly change the oscillation period, so during the period measurements the amplitude must remain between the maximum and minimum amplitudes specified.

Draughts (such as from a door opening). The measurer should ask for an enclosed space in a rigid building, not a tent. Perturbations due to draughts show up when one out of

several swings checked by the electronic timer gives a markedly different value. Usually one can notice the draught “gust” at the time. This value should be discarded.

Lack of rigidity. The supporting structure for the swing hooks must be very rigid. In particular, the swing frame needs to be on a concrete or similar base. The result of flexibility is that the oscillation periods will be too great, causing the calculated radius of gyration to be too large. Movement of the hooks relative to the hull when changing the axes can also lead to errors. At a regatta Equipment Inspection, try a known boat first!

Water in the hull or loose and extraneous equipment. Erratic results are an indicator of free water moving somewhere (buoyancy tanks, double bottom stiffeners etc.). When weighed during the preliminaries to a regatta, the boat must be in a clean and dry condition. If, during a regatta, further inspection is required, the boat will not be dry. In particular, water absorption will have taken place on hiking straps and padding, which are likely to be nearer the CG of the boat than the radius of gyration. If the boat is swung in this condition, the radius of gyration may well be smaller than the minimum distance allowed, see figure H.4.1.2.

You can get a very good idea about whether the boat would be correct when in the dry condition by using Moments of Inertia. Since the Moment of Inertia is

$$M\rho^2 = \Sigma(m_1 r_1^2 + m_n r_n^2)$$

it cannot be reduced by the addition of the weight m_n , i.e. $Wet M_w \rho_w^2 \geq Dry M_d \rho_d^2$. If the boat in question is re-weighed and swung, then the new Moment of Inertia should never be less than the dry original, even though if r_n is less than ρ , the radius of gyration may have become less.

This brings up an interesting point about old boats which, much like their owners tend to gain weight around their middle. If a new Finn is at minimum weight, $M = 116$ kg and minimum radius of gyration $\rho = 1100$ mm, i.e. moment of inertia is $I = 140.36$ kgm².

If now the hull gains say 5 kg at 200 mm from its CG, then the new moment of inertia is

$I = M\rho^2 + mr^2 = 140.36 + 5 \times 0.2^2 = 140.56$ kgm², i.e. larger, but the radius of gyration is $\sqrt{I/(M+m)} = \sqrt{140.56/(116+5)} = 1082.3$ mm so less than before. Thus this hull would require even more weight to be added at its ends to be Finn class legal, a double penalty. This is one reason why the Europe class specifies the moment of inertia rather than the radius of gyration.

There have been many variations in the hook and knife edge designs in order to facilitate rapid changes between the two axes without changing the position of the hooks on the hull. The Europe Class uses a hook which is changed in length so the knife edge crossbar can remain fixed. In practice this is not ideal and is theoretically incorrect as the swinging object, which includes the hooks, changes geometry. Provided all hulls are measured with the same hooks this systematic error is constant and so not a problem.

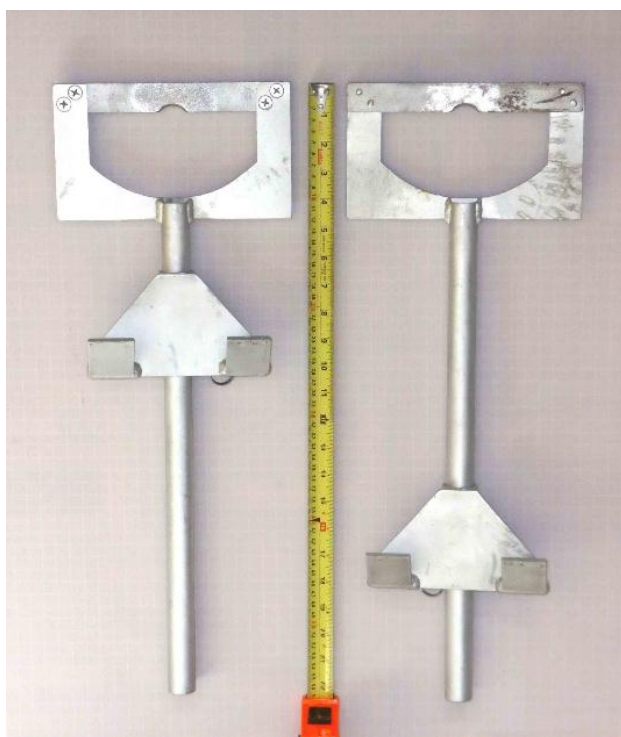

Figure H.4.2.5 The Europe Class Hooks in the axis O_1 and Axis O_2 configurations.

H.4.3 Snipe Class swing test & Lightning bounce test

At the same time that Gilbert Lamboley introduced his test for the Finn Class, Ted Wells introduced a different technique for the Snipe Class. For the Snipe test the hull keel rests on a pivot on the floor, thus eliminating the requirement that the gunwales have to be strong enough to support the hull suspended on hooks. The centre of a calibrated spring, which is inclined to the vertical, is attached to the bow at a specified distance from the pivot, and provides the restoring torque, see figure H.4.3.1. The period of oscillation is again measured, but in this case the moment of inertia about the pivot bar is controlled so the position of the hull CG is not required.

The moment of inertia of the hull is calculated from the following formula:

$$I = \frac{CD^2T^2}{4\pi^2}$$

Where: I = Moment of Inertia

C = Spring constant, (kg. per m.)

D = Distance to axis, (m)

T = Time of one complete oscillation, seconds

D = 2.6233 m

The spring constant will be furnished with springs from the Snipe Class. We can now simplify the formula to

$$I = 0.1743 CT^2 \text{ kg } m^2$$

The minimum moment of inertia of the hull, as determined from above formula, shall be 27.6 kgm^2 . If the hull moment of inertia does not meet the minimum, weight shall be moved to or added to the ends to bring the moment of inertia up to the minimum.

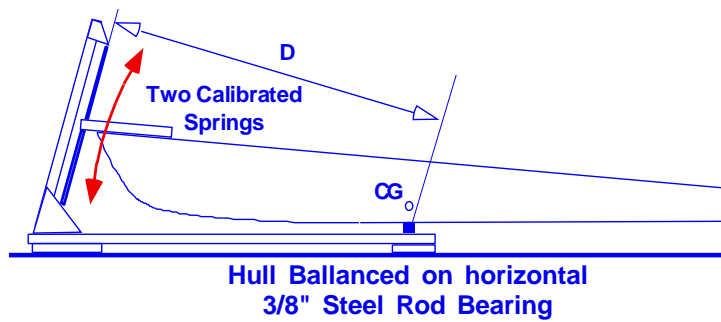

Figure H.4.3.1 *The Snipe Class Moment of Inertia rule.*

In 1965 Robert Smither developed a method of measuring the moment of inertia of a fully rigged Lightning (without the sails) while it was on its trailer. His aim was to investigate the difference in weight distribution between wooden and fiberglass boats as cheaply as possible. The tongue of the trailer was attached to a calibrated spring, of spring constant S , and by rhythmically pushing the trailer tongue the boat was made to oscillate in pitch about the trailer axle. The measured period of oscillation then gives the moment of inertia I_c of the boat plus trailer. A separate measurement on the empty trailer gives its moment of inertia I_t which can then be subtracted to obtain I_b i.e. that of the boat alone about the trailer axle. Separate measurements of the distance “ a ” of the CG from the axle are required in order to convert the result to the moment of inertia about the CG. Various methods such as resting the hull on its gunwale and measuring the balancing force required at the tip of the mast, or alternatively measuring the trailer tongue weight and its variation with angular displacement, were used to obtain the CG position.

The restoring torque is now supplied by the calibrated spring at a lever arm of D i.e. the horizontal distance of the hitch from the axle. For this setup in which the axis of rotation is below the CG the weight no longer supplies a restoring torque, thus if it is to be only a small perturbation the variation with angle of the gravitational torque, must be much smaller than that of the torque due to the spring.

The precision achieved was about $\pm 1\%$ and clearly differentiated between the wood and the glass boats. Estimating the uncertainty in the weight measurements as about $\pm 0.2\%$, the resulting uncertainty in the gyradius is $\pm 0.7\%$ or ± 13 mm which compares favourably with the Lamboley test.

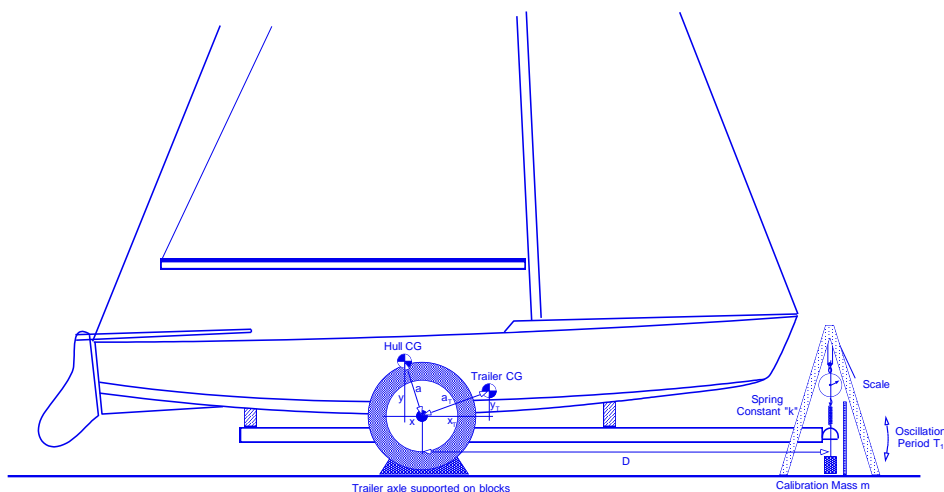

Figure H.4.3.2 *The Lightning bounce test.*

H.4.4 Dragon Class swing test

In 1986 when the Dragon Class was introducing glass hulls, a swing test was developed by Oskar Weber and Borge Borresen together with Tony Watts. For heavy keel boats it is too difficult and time consuming to change the axis of oscillation, as for a Lamboley test, and so the depth “a” of the CG below the axis is determined by an incline test, and can then be used to convert a single period measurement T into the radius of gyration as in the Lamboley test.

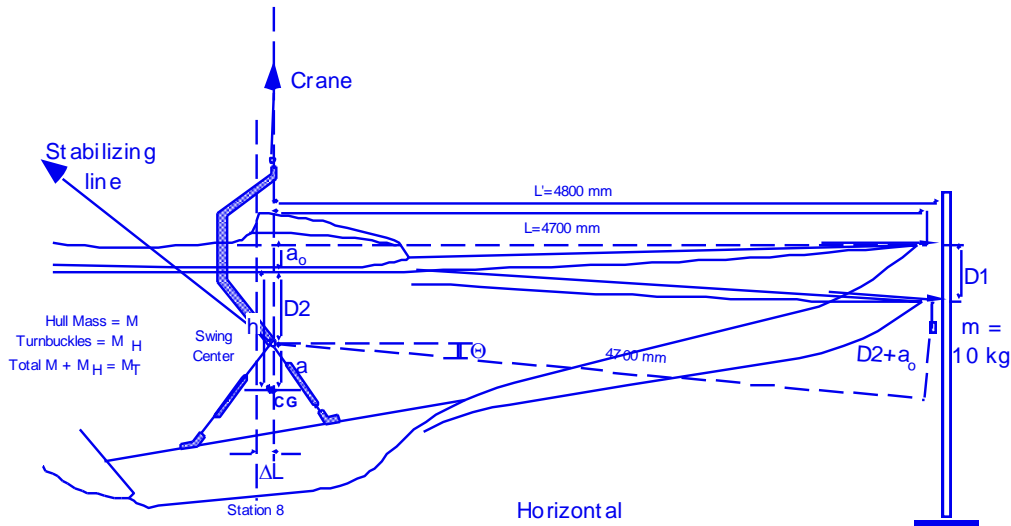

Figure H.4.4.1 *The Dragon Class swing test.*

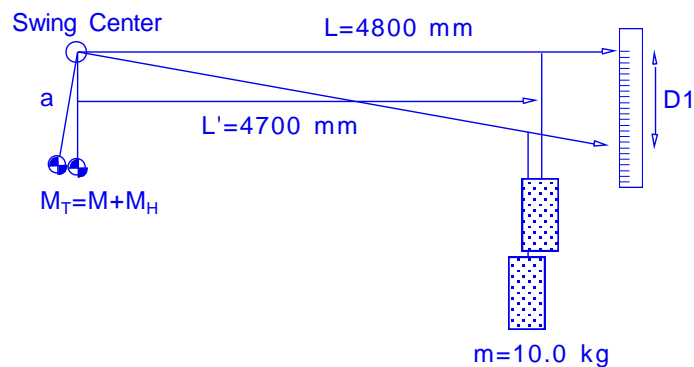

Figure H.4.4.2 *The Dragon Class incline test.*

The hull is suspended from a horizontal bearing as shown in figure H.4.4.1 and levelled. The fore and aft and vertical position of the swing centre is specified in the rules, see below, and the deflection D1 of a pointer on the bow, at L = 4800 mm horizontally from the swing centre, is recorded when a weight m = 10.0 kg is suspended at L' = 4700 mm. The depth “a” of the CG below the swing centre is then given in terms of the total mass $M_T = M + M_H$ by taking moments, with the hull of mass M and the added support components which swing with the hull as M_H . Then

$$\text{Swing Centre to CG} \quad a \approx \frac{mLL'}{M_T D1}$$

There are some minor corrections to this due to the pointer not being at the level of the swing center, but as these are the same for all hulls they can generally be ignored. Then again

$$\rho = \sqrt{a \left(\frac{gT^2}{4\pi^2} - a \right)}$$

Radius of gyration

However, although this was recommended, the Dragon Class opted to adopt a rule specifying limits on the deflection D1 and 10 times the period T, as specified below:

Dragon Swing Rule

10.21 When the hull as defined in rule 10.10 is swung from the class approved swing test gear then:

- (a) the centre of the bearing point of the swing test gear ("the swing centre") shall not be less than 40mm nor more than 90mm forward of station 8 of the hull.*
- b) when 10kg are placed 4700mm forward of the swing centre the distance by which a point on or level with the deck 4800mm forward of the swing centre shall drop below its original position shall be measured ("D1").*
- (c) the depth of the swing centre below the sheerline ("D2") shall not be more than 550mm for a "D1" measurement of 350mm or where D1 is greater or less than 350mm D2 shall be such a distance as is proportionate thereto calculated by the following formula:*

$$D2 < 938.29 - \underline{135899}$$

D1

Provided that if the weight of hull specified in rule 10.10 is more than 1650kg D2 may be increased by 1mm for every 4kg that the weight of the hull exceeds 1650kg.

- (d) when the 10kg weight in sub paragraph (b) is removed the hull shall be allowed to oscillate for 10 cycles and then time taken shall be not less than 46 sec. for a "D1" measurement of 350mm plus or minus 1 second for every 20mm by which the "D1" is either greater or less than 350mm.*

The results are then evaluated using an empirically derived graph as shown below.

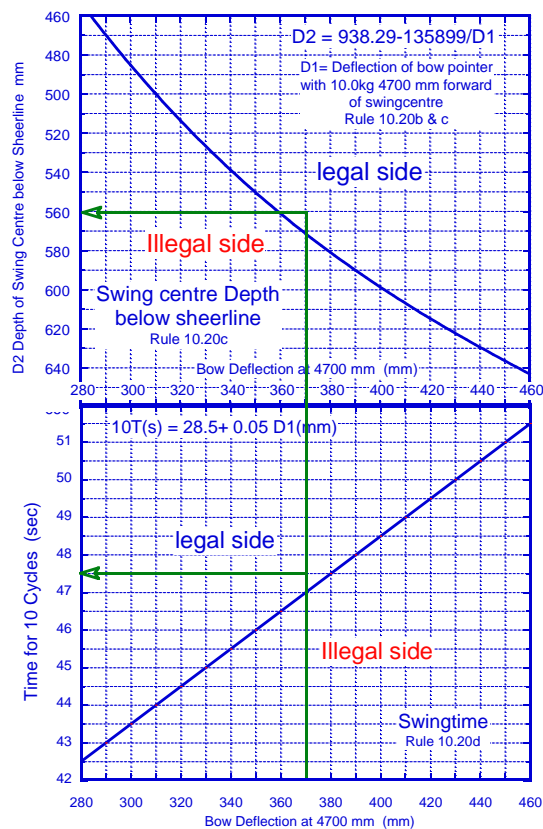
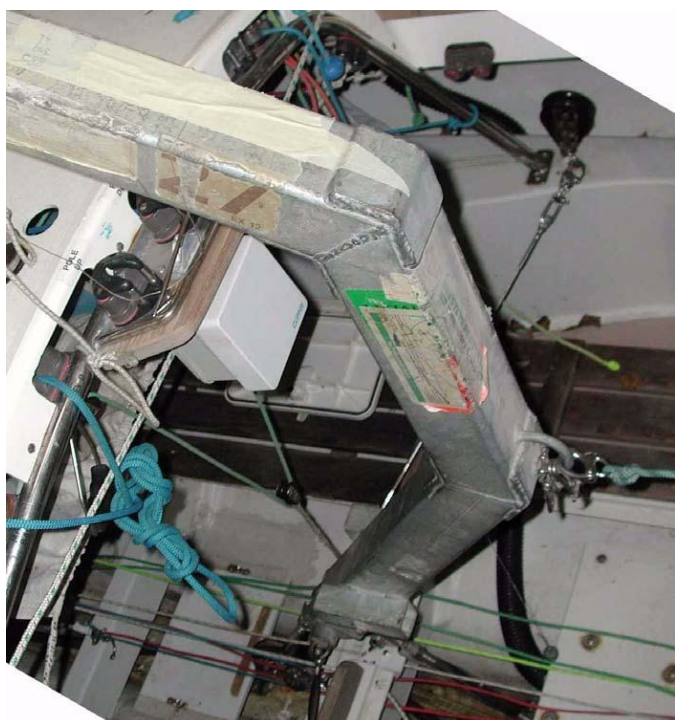

Figure H.4.4.3 The graph used to define a legal Dragon. A hull with $D2 = 560$ mm which is deflected by $D1 = 370$ mm and takes 47.5 seconds for 10 swings is legal as shown.

A recent investigation using an electronic inclinometer interfaced to a laptop allowed more precise measurements of the inclination and also allowed the decay of the amplitude and the accompanying change in oscillation period to be investigated. This dependence of the measured period on amplitude appears to be bearing dependent and limits the ultimate reproducibility.

Figure H.4.4.4 The Dragon swing system mounted in the hull, which has its bow to the left. The swing bearing is at the bottom of the arm and is attached to the hull by means of four turnbuckles. The steady line, which inhibits motion of the swing centre, can be seen attached to the eye on the arm.



H.4.5 Star Class swing test

Bill Parks of the Star class pioneered a different approach in 1975. This technique measures the yaw moment of inertia by suspending the hull from a crane with a swivelling hook and attaching a pair of horizontal springs at the bow. The principle is the same as that of the Snipe test except that the rotation is about the yaw axis. It has been used by NACA in the 1930s to measure full size aircraft. The CG is directly below the point of suspension and therefore on the axis of rotation, thus “a” is zero. There are, however, a number of problems with this elegantly simple method. When the hull swings in yaw the pivot must exert a force which is equal and opposite to that due to the springs at the bow and it is difficult to prevent any lateral motion of the suspension hook. The hook is also not at the same level as the bow springs and thus sways and roll motions develop. These problems together with friction at the bearings and varying torsional rigidity of the suspension led to irreproducible results from site to site. At the present time the Star class has deferred any further action until there is clear evidence that a rule is required.

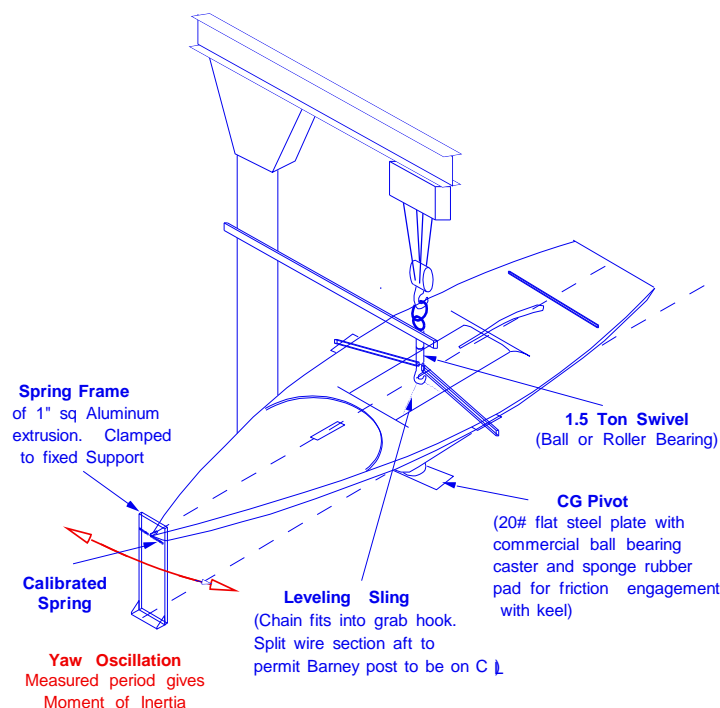

Figure H.4.5.1 For the Star swing test the hull was suspended by a crane from a thrust bearing with two calibrated horizontal springs at the bow, and the period of yaw oscillation measured to determine the moment of inertia about a vertical axis.

H.4.6 Stewart 34 Class swing test

In 1987 Tom Yates of the Royal New Zealand Yacht Squadron wished to ensure that the wooden and fiberglass Stewart 34s used for match racing, were as equal in performance as possible. They therefore performed incline-swing tests on the boats, see figure H.4.6.1. Tests on one hull, which was loaded with extra weights in specified locations, indicated that both the CG position “a” and the radius of gyration ρ could be determined to $\pm 1\%$. Once organized, the tests required only one hour from haul out to re-launch.



Figure H.4.6.1 A Stewart 34 undergoing a swing test in New Zealand in 1987.

H.4.7 Yngling Class tilt swing test

One of the ISAF requirements for Ynglings when they were chosen for women’s fleet racing in the 2004 Olympics was equalized weight distribution as it was known that builders could arbitrarily position about 20 kg within the class construction rules. Unlike the Dragon class, which essentially only swings hulls at the builder’s yard, the Ynglings would have to be swung at regattas, thus the requirements on the system were that it be transportable, inexpensive, precise and could be quickly mounted in hulls from all the builders during regatta inspection.

Eric Salling of Borressen devised the initial system which was then further developed to employ a tilt measurement to determine the swing axis to CG distance “a”, as shown in figure H.4.7.1 using the system shown in figure H.4.7.2. The hull was tilted by moving the swing axis along a rail by precise distances D1 and D2, measured by an electronic scale with precision ±0.01 mm. The levelling of the hull, and the angles θ_1 and θ_2 were measured with an electronic inclinometer of resolution ±0.1 degrees. This was more precise and avoided the difficult measurement L in the incline test. The inclinometer was also subsequently used to record the oscillations of the hull, from which a precise period could be extracted using Excel as a fitting program, and subsequently the CG depth “a” and radius of gyration “ ρ ”.

If D is horizontal and “a” vertical then

$$D_1 = a \tan\theta_1 \text{ and } D_2 = a \tan\theta_2 \text{ so}$$

$$D = D_1 + D_2 = a (\tan\theta_1 + \tan\theta_2), \text{ then}$$

$$a = \frac{D}{(\tan\theta_1 + \tan\theta_2)}$$

Axis to CG

$$\rho = \sqrt{a \left(\frac{gT^2}{4\pi^2} - a \right)}$$

Radius of gyration

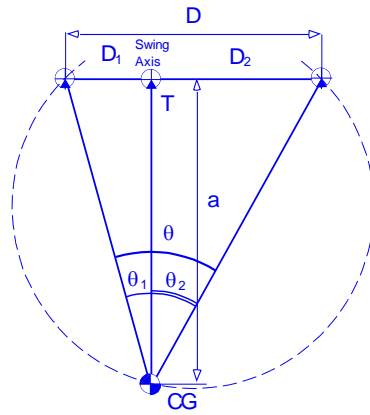

Figure H.4.7.1 The geometry of the tilt method of determining “a” the vertical distance of the CG below the swing axis by moving the swing axis a distance D and measuring angles θ_1 and θ_2 . If $D_1 \approx D_2$ then $a = D/2 \tan(\theta/2)$ and only the total displacement and angle are required, limiting the CG position to be on the dashed circle.

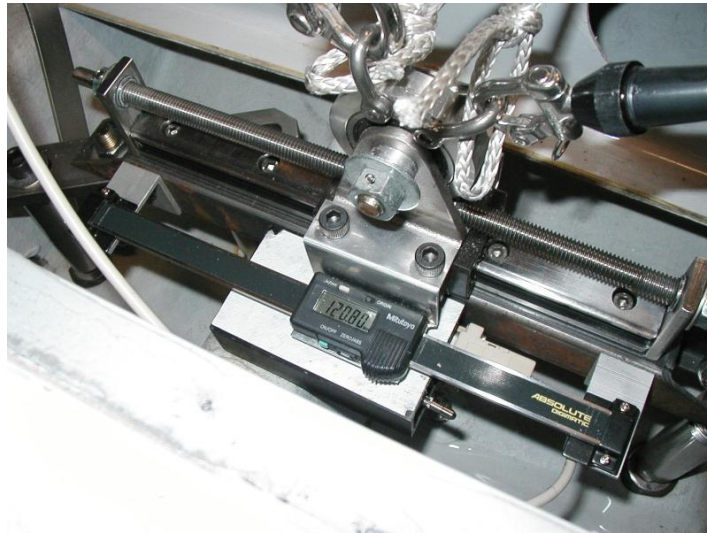

Figure H.4.7.2 The 2004 tilt swing system installed on the keel bolts of an Yngling. The swing bearing is mounted on a precision rail and the position read on the electronic scale. The box below the “rail scale” is the inclinometer. The roller bearing and the shackles for the support and steady lines of the suspension can be seen at the top of the photograph.

Figure H.4.7.3 An Yngling undergoing a tilt test



H.4.8 Bifilar suspension test

The yaw radius of gyration can be measured by rotating the hull about a vertical axis, as is done in the Star test, but by using two support lines of equal length l , symmetrically placed a distance d each side of the centre, the calibrated spring is no longer required. The system also has the advantage that for hulls with the CG on the centerplate the system is self-aligning, i.e. the CG is at the centre of the suspension and its position need not be measured, thus only one period of oscillation is required. The insensitivity of this test to off centre positioning of the CG has been confirmed by measurements on an International 14, and its sensitivity confirmed to be better than ± 2 mm by placing up to 5 kg at various positions in the 94 kg hull. The bifilar suspension is a well-known technique for measuring moments of inertia, was extensively used on full size aircraft in the 1930s and is currently used for precise measurements on UAVs and tank test models.

Although the yaw radius of gyration is not quite the same as the pitch radius of gyration, they both measure the fore and aft weight distribution, and for many dinghy classes have almost the same value. For modern keelboats the yaw radius of gyration is a better indicator of light end construction of the hull, as the keel is less of a factor about the vertical Yaw axis than it is about the horizontal pitch axis.

The hull is suspended as shown in figure H.4.7.1, either with the athwartships system as is usually employed, because levelling the hull places the CG in the plane of the suspension, or longitudinally as was used by H. Schoop in his investigations of the Lechner board prior to the 1988 Olympics. The bifilar suspension has been used to make measurements on Lasers, 470s, an International 14 and to voluntarily measure Flying Dutchmen at the '84 and '88 Olympics, and at the 1990 World Championships in Newport (where 75 hulls were measured in three days).

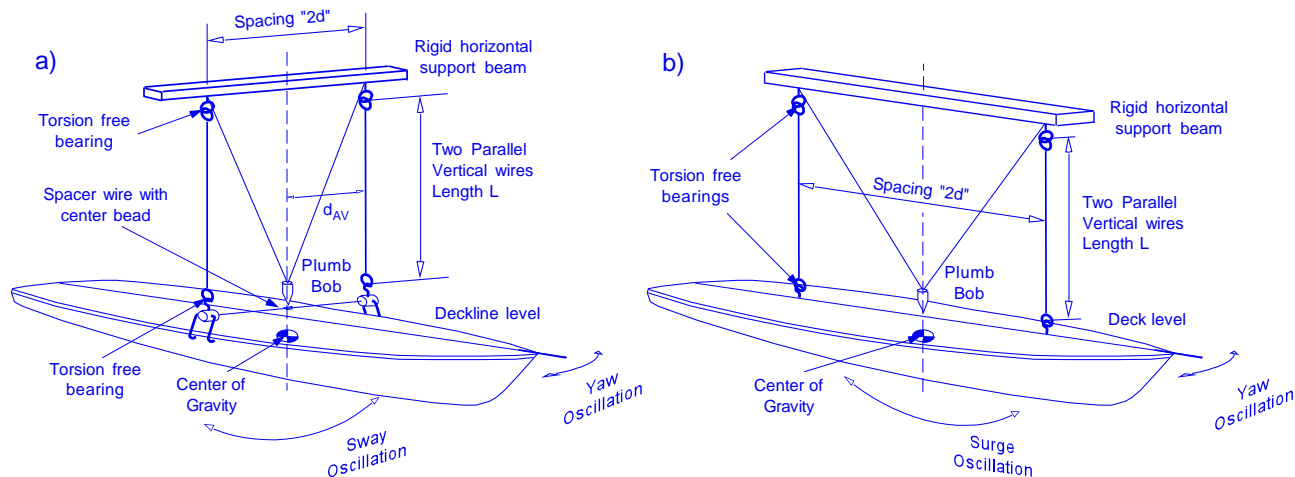

Figure H.4.8.1 Athwartships and longitudinal bifilar suspensions of a hull. The plumb bob locates the centre of the suspension and could be replaced by a laser beam.



Figure H.4.8.2 A Flying Dutchman on a bifilar suspension at the 1988 Olympics in Pusan. Note the lightweight hooks and cross wire. The Lambolley hooks were used for subsequent pitch radius of gyration measurements for comparison.

When the hull is rotated in yaw about its centre, as shown by the plumb bob, and released it oscillates in yaw with a period

$$T_y = 2\pi \frac{\rho_y}{d} \sqrt{\frac{l}{g}} \quad \text{and} \quad \rho_y = \left(\frac{2\pi}{d} \sqrt{\frac{g}{l}} \right) T_y$$

Thus the radius of gyration is directly proportional to the measured period T_y , and the constant of proportionality depends only on the geometry of the suspension. Generally the length l is chosen to be as long as allowed by the available gantry. For simplicity and in order to make the suspension as light as possible the spacing $2d$ is made close to the hull width, ideally a simple fraction of the expected yaw radius of gyration.

The yaw radius of gyration ρ_y is also directly proportional to the period T_y , not the difference of the squares as in the Lambolley test, so is inherently much more precise. However, for simple timing significant sway modulation must be avoided and this can be done by releasing the hull while keeping its centre under the plumb bob, which reduces the sway to less than 1% of the yaw amplitude at the bow. The use of a MEMS gyro, such as that in the iPhone to record the yaw motion eliminates the sway as the gyro only measures the yaw.

The bifilar suspension prevents any roll rotation thus the sway period is

$$T_s = 2\pi \sqrt{\frac{l}{g}} \quad \text{and thus} \quad \rho_y = d \left(\frac{T_y}{T_s} \right)$$

One only needs to measure the spacing $2d$ and the ratio (T_y/T_s) of the two periods, which turns out not to even require a stop watch! If the spacing d is adjusted until the two periods are equal then: $\rho_y = d$

However, in general it is not practical to adjust d . In that case one only needs to hold the bow fixed while displacing the stern, i.e. both rotating the hull in yaw and displacing the CG in sway, such as to produce essentially equal oscillation amplitudes at the bow. On release, the bow will hardly oscillate; the bow oscillation will build but subsequently decrease again before the cycle repeats. This is called a beat motion, and by just counting the number of oscillations “ n ” per beat, or averaging over a few beats, the ratio (T_y/T_s) can be determined. The yaw radius of gyration is then

$$\rho_y = \frac{T_y}{T_s} d = \frac{2n+1}{2n-1} d = \left\{ 1 + \frac{1}{(n-0.5)} \right\} d$$

For example for $d = 900$ mm and $2n = 15$ then gives $\rho_y = 1038$ mm. The closer d is to ρ_y the better this works, as “ n ” becomes larger (becomes infinite for $\rho_y = d$). It is difficult to count close to the minimum so using a cell phone to film the motion for later inspection may be beneficial. During measurements on the 2004 Gold medal Yngling, the motion of the stern was recorded and is shown in figure H.4.8.3.

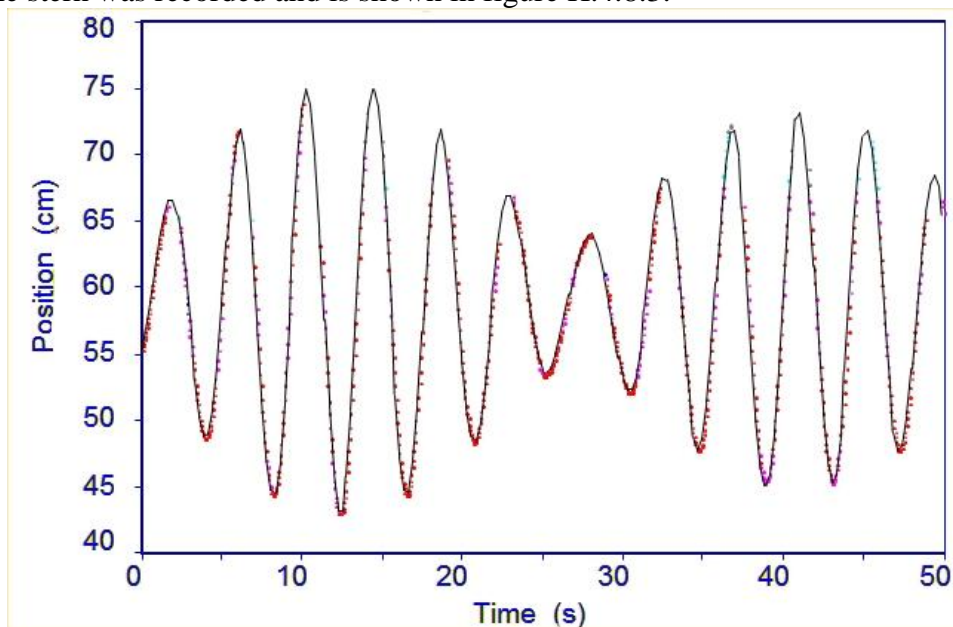

Figure H.4.8.3 Measurement of an Yngling hull in combined sway and yaw. The ratio of the two periods (T_y/T_s) was derived from a least squares fit of a mathematical function to give a precise yaw radius of gyration ρ_y .

H.4.9 The complete boat

A Lamboley test has been performed on a complete Flying Dutchman, sails included, but this it is not in general practical. However, it is the total boat which goes sailing, and even hopefully with a crew on board. Thus if one is to evaluate the sea keeping properties the whole boat should be considered. Fortunately, at least under the simplifying assumption of a rigid structure one can easily calculate the radius of gyration of the whole boat by entering the data on the individual components into a spreadsheet.

The CGs of each component can be found as above, or by suspending them with a plumb bob, from two separate points, and marking their intersection. The CG to one point of suspension can then be measured and the time of oscillation measured to obtain the individual radii of gyration as above. The locations of the CGs relative to the coordinates of the hull are then entered into the spreadsheet together with the masses and radii of gyration to calculate the total CG and moment of inertia.

Table H.4.9.1 CG positions, gyradii and moments of inertia of the components of a Finn Dinghy when going to windward

Component	Mass		Position		Radius of	Moment of Inertia		
	kg	%	x m	y m	k m	I_0 kgm ²	I_{CG} kgm ²	I_{CG} %
Lamboley Test								
Hull, C/B, hooks etc.	122.75		2.100	0.10	1.100	148.5		
Finn sailing to weather								
Hull	106.34	75.5	2.05	0.08	1.16	143.9	147.1	52.5
Mast	8.00	5.7	3.59	2.20	1.77	25.1	73.4	26.2
Sail	2.38	1.7	2.19	2.91	1.84	8.09	25.0	8.91
Rudder	3.98	2.8	-0.04	0.08	0.44	0.77	19.3	6.87
Boom	5.60	4.0	2.19	0.55	0.98	5.36	5.92	2.11
Centerboard down	11.11	7.9	2.42	-0.28	0.31	1.03	5.16	1.84
Paddle	0.57	0.4	0.30	0.00	0.29	0.05	1.95	0.69
Compass	1.41	1.0	2.91	0.33	0.04	0.00	0.91	0.32
Painter	0.23	0.2	0.30	0.00	0.03	0.00	0.77	0.27
Bailer	0.14	0.1	0.30	0.00	0.01	0.00	0.47	0.17
Tiller extension	0.23	0.2	0.90	0.35	0.01	0.00	0.34	0.12
Mainsheet	0.91	0.6	2.10	0.42	0.08	0.01	0.03	0.01
Total Finn	140.9	100	2.11	0.24	1.41		280.3	100

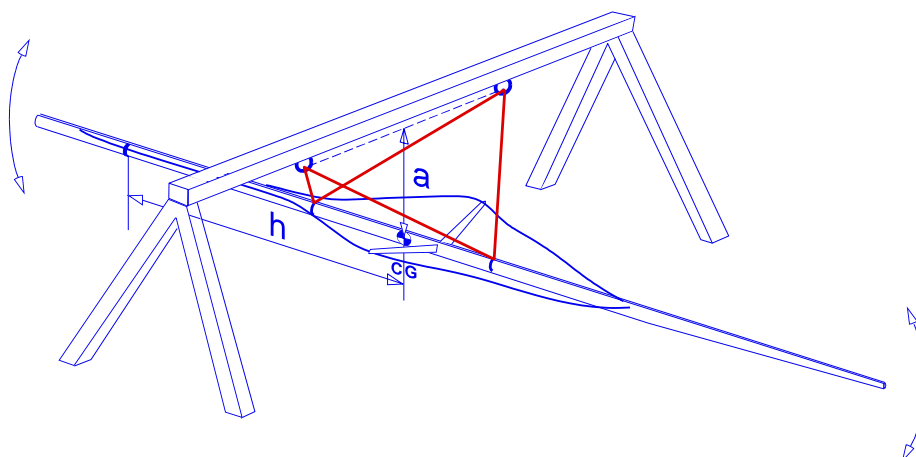

Figure H.4.9.1 To measure the gyradius of a mast suspend it horizontal and perpendicular to a fixed boom with a light cord, from two eyes as shown: measure “a” to the CG and then the period of oscillation T.

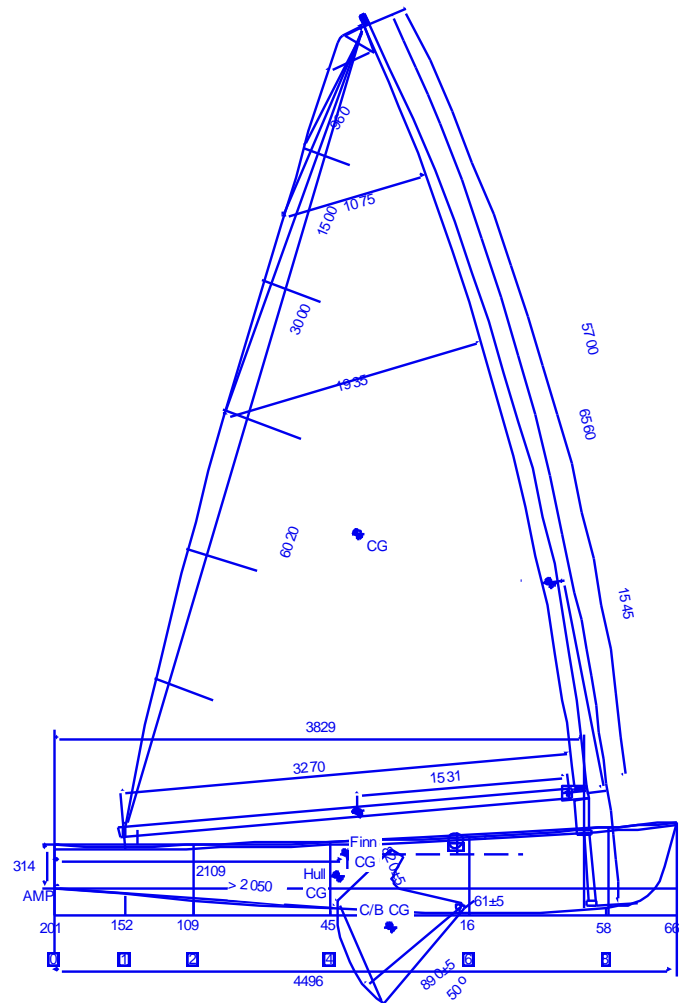

Figure H.4.9.2 *The components of a Finn, with their CG positions for windward sailing.*

H.5 Buoyancy

Most dinghies and some of the smaller keel boats have buoyancy equipment which will keep them afloat in the event of capsizing or knockdown. It will normally be of sufficient size and distributed so that crews can recover from the situation without outside assistance.

H.5.1 Buoyancy apparatus

The buoyancy equipment will normally be in the form of one or more of the following:

- Inflated air bags,
- Buoyancy compartments or tanks in the hull,
- Foam blocks,
- Foam between the skins of an FRP sandwich construction boat.

Many classes are required to have, inside the buoyancy tanks, sufficient foam blocks to keep the boat, its equipment and crew, afloat in the event of a major accident causing the tanks to flood. (GRP boats and keel boats might otherwise sink).

Once the boat has been completed it is always not possible to determine whether the secondary buoyancy is of the required quantity - that can only be done during the manufacture of the boat - but it is possible to see whether foam blocks, or other approved equipment, have been fitted.

H.5.2 Immersion buoyancy tests

Many classes require the buoyancy equipment to be tested by immersing the boat in water to simulate a capsize or swamping. Such a test may be used to establish immersion firstly, that there is sufficient buoyancy to prevent the boat from sinking, secondly to check that there are no leaks in the buoyancy equipment, thirdly to show that buoyancy is distributed in the boat satisfactorily, so that the boat floats approximately level when waterlogged, and finally to ensure that the buoyancy, if moveable, is strongly fixed in position.

When a buoyancy test is prescribed in the class rules, the test must be conducted strictly in accordance with those rules.

An immersion test is normally carried out by flooding the boat by opening drain ports etc. and loading the boat with a specified minimum weight, either by means of weights or by having people on board. It is usual to require the test to be carried out in three stages; with the boat upright and then on each side in turn.

When weights are used in a test special care needs to be taken during the time they are in the boat as the failure of a buoyancy unit or its fastenings may cause movement of the boat and dislodgement of the weights with resultant damage to the hull.

Loss of air in bags is not acceptable. It is frequently not possible to see evidence of leaks in bags while the test is in progress, due to the movement of the water in and around the boat. Apparent deflation of a bag due to cooling by the water should not be confused with a leak.

Inflated buoyancy bags exert a considerable upward force on their fastenings, and because they are flexible they may distort extensively when the boat is swamped. A bag which does distort exerts a considerable load on the loops over the fastenings and should not be accepted. The loops on the buoyancy bags are not for the attachment of fastening straps, they are there to position them. There should, in general, be not less than three straps for each buoyancy bag although the number depends on the size of the bag. The straps should be fairly tight so that the bag does not lift - in addition to allowing the swamped hull to sink further they permit the bag to move with the result that chafe occurs with subsequent leakage. The attachment of the fixing straps to the hull should be carefully inspected before and after a buoyancy test to ensure adequate strength.

H.5.3 Buoyancy tank air test

The design of many modern dinghies is such that it is difficult to test satisfactorily all the joints of a buoyancy tank without applying a very large load to the waterlogged boat.

Because of this some classes now specify a test which does not rely upon immersion in water. This is a test in which the tank is subjected to a small increase in internal air pressure or, in the case of the vacuum test, a small decrease in pressure. The pressure difference between the inside and outside of the tank is indicated on a water manometer fitted to a hatch cover or drain hole. The test will be satisfactory if the pressure drop does not increase faster than a certain rate; the rate and initial pressure difference being specified in the class rules.

Since buoyancy tanks are designed to be subjected to external pressure it is preferable to carry out the test by reducing the internal pressure of the tank.

A major object of testing a buoyancy tank is to test as many of its joints as possible. There are frequently inspection hatches and drain plugs all of which must be firmly closed before the start of the test. Nevertheless, these are sometimes the sources of a leakage into the tank. The fact that there is a small leak in a tank does not necessarily indicate that it is unsatisfactory.



H.5.4 Buoyancy inspection

There are many classes which do not specify a buoyancy test but which nevertheless require the measurer to satisfy himself as to the effectiveness of the buoyancy. He can often see if there are any very major deficiencies or leaks but the only way to be certain that the construction is entirely satisfactory is to carry out either an immersion test or an air test.

H.6 Measurement with Ultrasonic Thickness Gages

H.6.1 Introduction

This section discusses non-destructive ultrasonic methods for measuring the thickness of fibreglass boat hulls and decks. Some general measurement guidelines are provided along with some practical limitations related to the use of ultrasonic testing.

Ultrasonic testers operate on a pulse-echo principle much like the sonar. They measure thickness by precisely measuring the round trip travel time of very high frequency sound waves emitted from a piezoelectric transducer and returning to it. The transducer is held in contact with the outer surface of a boat hull. Sound waves emitted from it bounce off the inner wall of the hull and back to the transducer. A calibration process determines the speed of travel of the sound waves passage through the hull allowing an accurate measure of the hull thickness to be obtained.

$$\text{Thickness} = \text{Sound Velocity} \times \text{Round Trip Time} / 2$$

Many electronic ultrasonic measuring devices have built-in calibration programs that do the velocity of sound calibration calculation automatically by measuring two different samples of the material of known thickness. Usually, the samples span the expected range of thickness to provide as accurate a calibration as possible in between. For thickness measurement on fibreglass boats it is important to perform calibration with actual samples that are taken from the hull or deck of that type of boat because the velocity of sound can vary significantly depending on the specific material used in the lay-up and the quality of workmanship used. Once calibrated, the electronic ultrasonic thickness gauge can measure a hull or deck thickness in a matter of a few seconds without any damage to the boat.

The reasons for measuring the thickness of the lay-up are to detect problems with the fabrication process or to identify subsequent alterations to the hull or deck lay-up that are not authorized. This can be accomplished because the construction plans specify a lamination schedule and finishing schedule than can be converted to an overall thickness for the hull or deck at any point. With the ultrasonic gauge it is easy to look for changes in thickness at the expected location to determine if the lay-up was correctly performed and the proper material was used. The ultrasonic gauge is an excellent tool to spot check for alterations in the hull or deck construction because even minor changes in thickness are easily determined. Because voids or improper types of material have a proportionately large effect on the velocity of sound, significant changes of the local reported thickness result. This spot check can help pinpoint suspect areas that could be candidates for further investigation using destructive measurement methods.

H.6.2 Considerations

There are a number of practical considerations that need investigation before ultrasonic thickness measurement should be undertaken. Some of these considerations may make using ultrasonic techniques inadvisable.

There is a practical upper limit and a lower limit of thickness for ultrasonics to work on fiberglass hulls. The range of thickness measurement is also a limitation, often necessitating more than one transducer to cover the range needed for hull and deck measurement. Thicker hulls require larger diameter and more expensive transducers to achieve a good return echo signal. The larger transducers often do not conform well to the curvature in the surface of a hull. This may limit its use in some critical areas of interest. As a guideline, expect good performance over a thickness range of about ten to one for a single transducer. For a large transducer of 30 mm diameter, this may be 2mm to 20mm of thickness in fiberglass. For a small transducer of 10 mm diameter, the useful range is typically from 0.5mm to 5 mm thickness.

The ultrasonic technique requires coupling of the piezoelectric transducer to the hull or deck using a gel type ultrasonic couplant between the active surface of the transducer and the surface of the hull or deck. The couplant layer thickness is part of the measurement. Some practice is required to get the correct contact force to squeeze the couplant out uniformly time after time so as to not adversely

affect the thickness repeatability. This is harder to do with large diameter transducers than with small ones. When the hull surface is curved the contact force is not a problem because the contact area is a line and the couplant is easily displaced. However, it is important here to use only enough couplant to obtain a reading because excess couplant will form a fillet between the transducer and the hull where sound can be trapped causing erroneous readings of thickness.



The roughness of the inner surface of the hull or the inner or outer surface of the deck can adversely affect the accuracy of the thickness reading in two ways: first, the amount of couplant required to obtain reliable reading increases with the roughness of the outer

surface. Too much couplant can reduce measurement accuracy and second, the minimum thickness that can be measured increases because the sound reverberates from a rough outer surface while the maximum thickness that can be measured decreases when the echo producing inner surface is rough. In fibreglass lay-ups, voids or large air bubbles produce scattering echoes that can appear just like the desired inner surface making the true surface difficult to discriminate. The presence of voids or de-laminations can result in measurements that seriously understate the actual thickness. Surface geometry can effect thickness measurement as well. A particularly difficult problem arises when the inner and outer surfaces are not parallel. The taper produces echoes that are distorted and this can reduce accuracy.

In most cases there are easy workarounds for most of these considerations but it is important to understand the factors that adversely affect ultrasonic performance.

H.6.3 Getting Started

In order to get started checking thickness it is necessary to know what the nominal thickness should be at the locations on the hull or deck selected for measurement. There are a number of ways to determine nominal thickness. One easy way is to measure a boat known to be built correctly, first with ultrasound then with a micrometre or calliper. It may not be necessary to drill any added holes as there are often holes for fittings available, at least in the deck. This is harder to do in the hull where it may be necessary to resort to a depth micrometre and a drill. Another approach is to measure a lot of hulls in exactly the same place on the hull using a calibrated ultrasonic tester and begin to build a data base of expected thickness readings. After a while the expected values become the nominal standard for comparison. This method works best when there are a lot of boats built in serial production because it takes a reasonably large sample size before the nominal thickness readings can be determined with confidence. The best approach to knowing the expected thickness is to look at the construction plans for building the boat. There should be a schedule of materials for the lay-up specifying what to use and where to use it. Once the type of material and the location for its use are known, simply adding up the layer thicknesses gives a good estimate of the nominal thickness at any point.

Here are some guidelines for estimating the thickness of various materials:

Coatings:

While not technically considered part of the laminate, all coatings are measured by the ultrasonic tester and therefore need to be accounted for when calculating thickness. Gel coat thickness can be determined by sanding it down in an area and measuring the thickness. A good starting value is 0.6mm. Similarly, the thickness of the topcoat needs to be accounted for. A good estimate is 0.4mm. It is harder to measure by sanding because the inner laminate surface is often rough. The gel coat and topcoat together account for an estimated 1.0mm of the total thickness reading taken from the ultrasonic tester.

Glass Mat:

There are good general guidelines that serve the purpose of estimating the thickness of a resin/mat build-up. For 1 kg mat build-up assuming a 1/3 glass content, a good estimate of the thickness is 2.0 mm. “Fat” or “dry” laminates can cause this thickness to vary by about 0.1 mm. For 2 kg mat the nominal thickness is 4.0 mm +/- 0.2. Use this as a general guideline to scale for the type of mat specified for the lay-up under consideration.

Woven Roving:

Where woven roving is specified in the lay-up, special attention is necessary to account for its reduced build-up rate. As a good rule of thumb, the build-up of a specified woven roving layer will only be 75% as thick as the same nominal weight glass mat build-up would be. When calculating the thickness of a nominal weight of woven roving, calculate it just the same as glass mat then reduce the thickness by $\frac{1}{4}$.

When other materials are specified, some testing may be required to determine the rate of build-up. Once done, a similar calculation will allow conversion to thickness. Thus the total hull or deck thickness at any point can be estimated knowing the details of the lay-up specified in the build plans for that point on the hull or deck.

H.6.4 Technique

The electronic ultrasonic tester is a battery operated hand held portable device that can be used effectively by one person. The tester typically has a remote transducer attached by electrical cable of about one meter in length. To use the tester, apply the couplant that is furnished by the manufacturer to the active surface of the transducer. Place the tester in the calibrate mode and follow the instructions for calibration using a thick and thin sample. Once the tester is calibrated, it is ready for use on the boat.

Place the tester in one hand and the transducer in the other. Apply couplant before every reading. All testers have an indicator to show the presence of a valid reading. Some testers log the thickness automatically. If this feature is not available record each valid reading in a logbook for future reference. Fully charged batteries last for about one full day of operation. Recharging is required in between.

There are two methods for using an ultrasonic tester. The first is the spot-check method; the second is the grid layout method. The spot-check method is a quick and easy examination for obvious defects in construction or for any alterations afterwards. As few as ten readings can be taken in just a few minutes to get a general idea of the validity of construction. Points on the hull and deck are identified and measured and the thickness value recorded. These values are checked against the predetermined nominal expected value. If the readings are within the expected tolerance the boat is OK. It is recommended to do half the readings forward of the mast and half aft. Concentrate on the ends of the boat as there could be an advantage to lighter ends.

The grid layout method is a much more thorough investigation. It requires that the hull be marked with the location of expected thickness changes determined from the construction lay-up. In effect, a grid system is applied to the hull and the transition lines where the thickness is expected to change are related to a grid location. If the hull shape is controlled using hull templates, an easy way to construct the grid is to mark the location of the transitions in thickness on the templates so they may be directly transferred to the hull. Otherwise, a scale or batten may be used to find the transition locations by measuring from the deck line and other construction datum.

Look for three things: The thickness, the presence of a transition in thickness, and the amount of change in its value. This process takes more time than the spot check but provides a more complete examination of the hull and deck lay-up. It is not uncommon to record sixty thickness values from the grid for each boat. Serious defects can relatively easily be isolated for appropriate destructive testing to determine the precise details of fabrication irregularity.

It is important to emphasize that the spot check and grid layout are screening methods useful in determining the possible locations of unauthorized construction or modification. It is not recommended to rely exclusively on ultrasonic testing as the definitive indication of the use of an improper material or as proof of error in lay-up. Ultrasonic testing has proved an excellent tool because it quickly locates possible irregularities. However, destructive methods are usually required for verification.

H.6.5 Data

Accurate record keeping is an essential part of ultrasonic measurement. In order to be able to faithfully reproduce readings the details of the procedure need to be recorded.

- Type of gauge (Manufacturer and serial number)
- Type of transducer (serial number if available)
- Calibration artefacts used (thickness of samples and where they were taken from)
- Velocity of sound calculated from the calibration (reported by the tester)

The rest of the data recording process relies on specifying the location for a reading and the thickness found there. The location should be specified sufficiently so that the readings can be repeated. This may require a location accuracy of 5 mm or better.

One reason for keeping this data is that the economic consequences of discovering improper construction may be considerable. Often there is follow-on investigation work that will depend on repeating the data recorded at measurement time. Ultrasonic measurement has been used at the championship level to identify boats where unauthorized material was used, where layers of laminate were missing, and where layers were not of the prescribed thickness. In each case destructive follow-on investigation supported the initial ultrasonic findings.

A final caution: Always check your data. In-process verifications are available if you look for them. For example, the ultrasonic tester may not be recording a change in thickness as required in a hull lay-up but you can feel a transition at the proper location by reaching inside the hull with your hand. Here the hull thickness may be correct but the local bonding of the layer in question may not be good enough for ultrasonic gauges to pick up the thickness change. In another example, the ultrasonic tester can show excessive thickness at the hull/deck joint. The actual thickness should be verified by removing a nearby fitting and using callipers. Local build-up near the hull/deck joint often produces a taper condition that can sometimes cause the tester to display a value that is higher than is actually there. In-process verification provides valuable assurance needed by an inexperienced user in order to apply ultrasonic measurement methods to fibreglass hull and deck thickness measurement with full confidence.

H.7 Laser Measurement Methods

H.7.1 Laser Tracker

Laser Trackers are used to gather point cloud data from a hull, a mould, or any other physical object. In a very general sense the laser tracks the position of a mating object and records positions of this object as it moves. The following description references the Faro-SMX Laser Tracker, which is widely used in industry for hull measurements.

The way the tracker operates is that a laser beam



precisely follows a precision steel sphere which contains a corner cube reflector with its apex at the centre of the sphere. This reflector precisely returns the beam to the tracker which then measures the transit time of the light pulse. The tracker head is gimballed, with motors which make it follow the centre of the sphere and precisely measure the azimuth and elevation angles (Latitude and longitude) of the centre of the sphere. The sphere and the tracker must always have an unobstructed view of each other and if the laser beam is broken, the track is lost.

With care and temperature stabilization etc. the instrument is capable of a precision of ± 50 microns in the position of the centre of the sphere. Under typical conditions inside a building or other structure the measurements are reproducible to better than ± 0.01 mm.

In order to be able to move either the object being measured (hull or otherwise), or the tracker, or to re-orientate in case the object (hull) is accidentally moved, a number of magnetic receptacles for the sphere, called “pucks” are firmly attached to the object. This is usually done on a boat hull by using masking tape to which the pucks were glued with a hot glue gun, but other options could be as effective. This method ensures stable position of the pucks while making it easy to remove them without damage to the hull. For a typical hull measuring activity, experts typically use five pucks, which are at the bow, stern, centre and port and starboard gunwale, and allow the sphere to be precisely repositioned in the same places relative to the hull. The laser tracker stores these reference positions and can compute its location relative to these fixed points allowing the tracker head to be moved if measuring a large object (hull).

Another method of using the sphere is by placing it on a puck at the end of a rod which has a point at the other end. By moving the sphere while maintaining the point in a fixed position on the hull, the tracker records data on the surface of a sphere and can then calculate its centre, i.e. the location of the point of the rod. This technique is called taking a sphere point. By using this technique for a number of points on the centreline the centreplane of the hull can be defined in the point field and the hull coordinate system established.



Figure H.7.1.1 49er with alignment pucks glued to surface.

Once a coordinate system is established it is possible to choose either to scan for sections, water planes or buttocks. In the scanning mode a set of planes and sections are chosen, as defined prior to starting and whenever the scanning sphere crosses the plane a point is recorded (and a sound generated). In this way by zigzagging across the plane

while touching the hull, a section can be generated, and eventually a set of half sections at the chosen spacing was recorded. The puck positions are then re-recorded.

The laser tracker can then be moved to scan the other side of the hull. By recording the puck positions from this new orientation special software can seamlessly join the port and starboard data to produce a set of complete sections.



Figure H.7.1.2 *Yngling ready for scan, Athens 2004 Olympic Games.*

To be effective and useful for normal hull measurement for classes, the hardware must be accompanied by appropriate software developed or modified to use measured section data as points to compare against surface of previously obtained master shape file. This “Master shape” may be defined from a master plug, survey of boats, or the original lines plan. A number of classes are already using digital versions of their original lines plans (420, Finn etc.) or are in the process of transforming them into digital format (Europe, 470, etc.). For those cases, it is rather easy to develop a master shape from the digital data files. However, as shown in Section H, there are a number of methods to define hull axis systems and to apply measurement tolerances. So, any attempt to replace standard measurement methods (hand-applied templates etc.) with a laser tracker system must be preceded by development of software and methodology to emulate the former accurately and consistently.

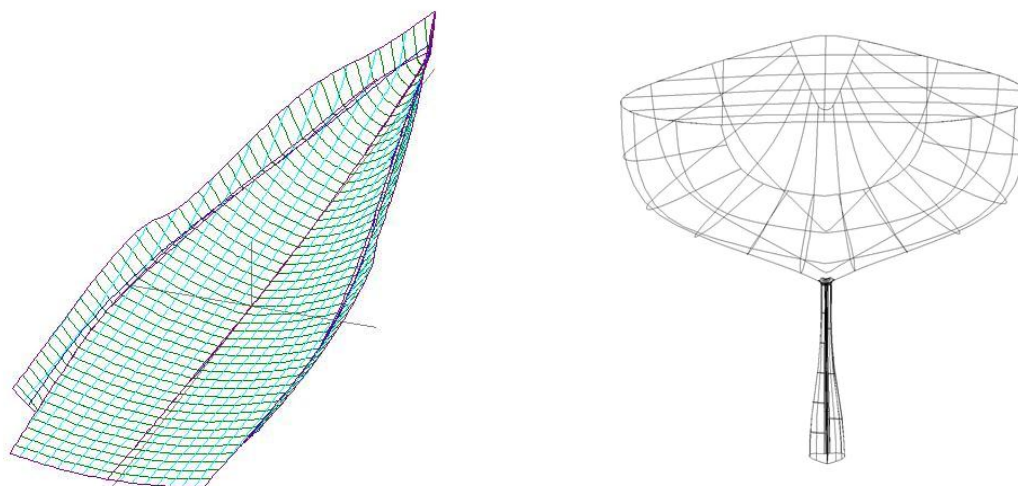

Figure H.7.1.3 *49er and Yngling (right) computer models defined from tracker measurement.*

H.7.2 Total Station

The name of “Total Station” defines an optical/electronic measurement instrument which is able to measure vertical and horizontal angles as its predecessor, the theodolite, and additionally to measure the distance of any targeted point using a laser electronic distance meter (EDM), up to distances of several hundreds of meters. Angles and distances are measured from the total station to points under survey, and the coordinates (X, Y, and Z or northing, easting and elevation) of surveyed points relative to the total station position are calculated using trigonometry and triangulation.



The system precision depends on the individual models, but can be on average around 2-3mm, when not degraded because of poor reflection of the beam, or when trying to measure on a tangent to the surface to be measured. Latest models offer a much improved accuracy of 0.5mm for targets less than 30 meters away from the unit.

The unit is usually operated from a small keyboard, has an LCD display, and can store thousands of point data in the machine internal memory. Acquired data can be easily downloaded after measurement to any pc in a variety of formats, using memory cards or sticks, or via a USB cable and even a Bluetooth connection.

These instruments first appeared at the end of the 90s, and are now commonly available everywhere in the world, at a price that decreases every year. They are manufactured by a variety of companies throughout the world and used mostly (but not limited to) for land surveying.

ORC has tested and developed a Total Station based method for hull offset measurement, where these instruments are used in a slightly different way than when used in topographic tasks. This is because they all have on-board software able to locate a hull measurement station, and set the coordinate system to 2 points that define a line on the hull's symmetry plane.

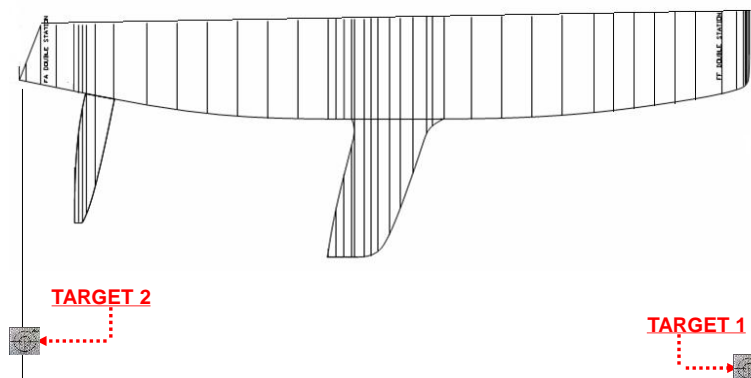

The setup of the machine station is performed with the classic inverse resection, basically finding the intersection of 2 arcs centred in the 2 reference points chosen. This is why there is no need to take “local” measurements on the tripod, as its height, which is a norm in most topographic applications of the same instrument.

The reference points to be identified and marked with targets are typically the bow knuckle and the transom centre, to be sighted by the first station location. They can be in other places according to circumstances, but they should be at or very close to the centre (symmetry) plane.

Sticking these two targets with small pieces of masking tape is the first step, to be done before pulling out and setting up the TS. The best targets have a very small size (about 1cm^2)

After setting up and switching on the TS in a position so both targets could be sighted and measured, and going through the final levelling of the head, the “Tie distance” program is called from a list- Then choose “Polygon”, then sight the two points in sequence to measure the horizontal (Hdist), vertical (Vdist) and diagonal distances. This will appear on the screen, and the 2 relevant figures have to be written down somewhere.

The horizontal and vertical distances just read are used to be manually entered as the “fixpoints” determining the coordinate system we use on boats, i.e. $X=0$ =bow, $Y=0$ =Symmetry plane, $Z=0$ approx. at the waterline. Therefore the point in the BOW will have East(X)=0, North(Y)=0 and Height(Z)=0, and the point at the STERN will have $X=x(0)+\text{Hdist}$ as read, $Y=0$, assuming it is in the centre plane, and $Z=Z(0)+\text{Vdist}$ as read.

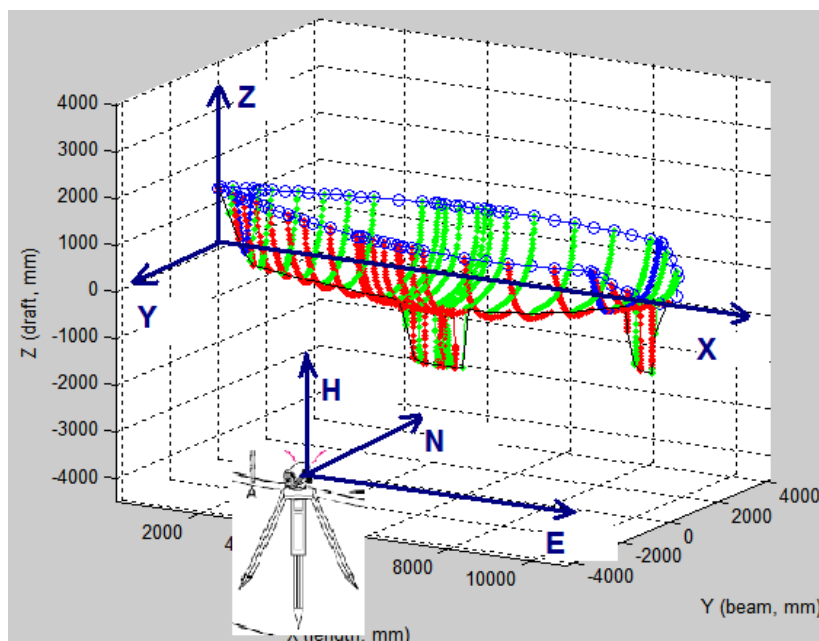

Next the “station Setup” program is called, the two reference points sighted again, then the position is calculated, and if the residuals are in a satisfactory range, the “set” command is launched, and the actual measurement can proceed. The station can be set at a given angle to the new coordinate system just set, a vertical one passing through the line between the bow and stern points selected.

The following step is to locate other targets around the boat so the station can be repositioned also in places where one or the other or both of the original points used to set up the reference coordinates are not visible.

Then you may want to make a further easy step, which is to take a station at the position of the tripod, setting the angle square to the plane, which would read as 360, or 200, or

400 depending on degrees or grads or other units as set up in the configuration of the instrument.

Once the horizontal angle is set, the points can be acquired in sequence as usual, just moving the vertical angle knob, usually on the right of the instrument.

Activating the EDM “tracking” mode, the machine keeps measuring and displaying the numbers on the display. If there is no reflection, the machine stops beeping. With the tracking mode activated it is possible to measure transverse stations at a longitudinal (X) distance different from the location of the tripod, just by adjusting the vertical and horizontal knobs until the X (Easting) value displayed is the one the user chose.

The process is repeated station after station, within the sighting range from the initial position.

The tripod can be relocated at any time, realigning the machine through the setup procedure.

The initial reference points can be used, and the additional ones (if added) to have a better check.

The minimum number of “base” points is 2 with a maximum of 5 that can be used for the station setup.

The IMS procedure prescribes stations to be vertical transverse ones at a maximum interval distance of 5% LOA (10% on each side) to be staggered in different positions along the length, except in a minimum of 2 or more stations that need to be double, in way of freeboard points, plus one or more in the middle of the boat. The double stations are used to check the hull's heel angle at the time of measurement, which can be corrected transforming the whole set of points, all measured to a common reference system.

The ORC is currently studying the inclusion of horizontal sections of the appendages, much easier to represent than by vertical stations, so having to place a vertical station that needs to be complete, to the whole hull.

Total stations have been seen at work at the Olympics to measure long and triple jump results, and are used for several years now to produce OFF files for the ORC, having the TP52 class as a forerunner of its use. Its use and procedures are in continuous development, and can be used for more practical works than measuring ORC hulls, such as drawing horizontal lines on a hull, check if an appendage is displaced, line up propeller shafts, or even measuring the rig even when the mast is on the boat.



INTERNATIONAL MEASURERS' MANUAL

SECTION I

Hull Appendages

I	Hull Appendages	
I.1	Profile	I 2
I.2	Section	I 3
I.3	Position	I 5
I.4	Other controls	I 7
I.5	Hull Appendage inspection at events	I 8

Hull appendages are items of equipment found wholly or partly below the sheerline or its extension when fixed or when fully exposed if retractable; they are attached to the hull or to another hull appendage and they are used to affect any or all of the following: stability, leeway, steerage, directional stability, motion damping, trim and displaced volume. ERS 2013-2016 don't offer a standard set of definitions other than the various type names, so uniformity in measurement methods is impossible. Therefore, classes follow their own systems but in general, class rules may control

- Profile shape (width and length, edge shapes)
- Section shape (thickness in various points)
- Position relative to hull
- Weight
- Materials

I.1 Profile

The profile of a hull appendage, that is the shape when viewed from the side, may be controlled by one of three methods:

- Measurements stated in the class rules,
- Plan or measurement diagram giving dimensions,
- Template.

The effect of each method is the same, to control, within tolerances laid down in the class rules, the shape of the appendage.

Where it is a requirement that the board or rudder is laid on a plan it is essential that any instructions in the class rules on how this is done are followed exactly. For instance, the leading edge of the board may have to be over the leading edge indicated on the plan.

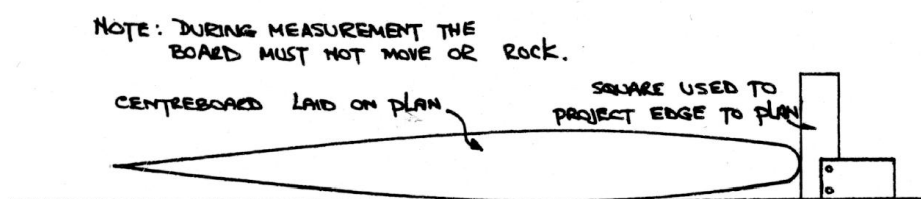

Figure I.1.1

The thickness of the board makes it difficult to check its conformity with the plan. The measurement has to be carried out on a flat surface, using a small square or similar tool to project the edge of the board down to the plan.

When a template is used the position of the template in relation to the centreboard can be varied in order to achieve the "best fit". If the measurement is carried out with a solid template the remarks above concerning laying the board on a flat surface apply. If the template is a hollow one which fits round the board the problems are not the same and, depending on the class, the measurement may be carried out with the board in the boat and fully lowered. In this case, if the board has to be in the fully lowered position there must be stops to prevent it being lowered any further.



Figure I.1.2



Figure I.1.3

Appendages should be carefully positioned on templates, observing any datum or other reference points. Depending on the specific class rules and the shape of each appendage, edge and corner shapes may be checked individually as in the 470 centreboard and rudder shown below, or the whole blade checked at once like the Finn rudder shown above.



Figure I.1.4

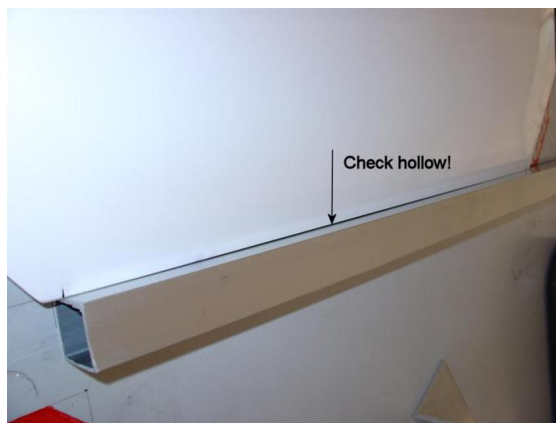

Figure I.1.5

I.2 Section

Section shape is usually controlled by measuring the thickness of an appendage, although this may be also achieved indirectly i.e. by limiting the width of a board slot in the hull.

Where a minimum and/or maximum thickness is specified in the class rules this can be measured using inside/outside callipers. However, a purpose made go/no go gauge is the tool of choice if many boards for the same class have to be measured. This gauge can be used in conjunction with either a calibrated wedge or a stepped gauge to obtain the actual thickness. A custom made system using an electronic micrometre can give the actual thickness in virtually every point of the appendage, but the board must be properly placed inside it.

Some classes require their appendages to be of even thickness. In order to check that this is the case, it is necessary to take several measurements of the thickness. It follows that if the centreboard is symmetrical and of even thickness the two sides must be flat, and therefore two straight-edges placed one on each side must be parallel and touch the surface of the board. However boards warp sometimes and therefore may not be flat. A

variation of thickness of 1mm is normally permitted, but in some classes the tolerance can be $\frac{1}{2}$ mm.



Figure I.2.1

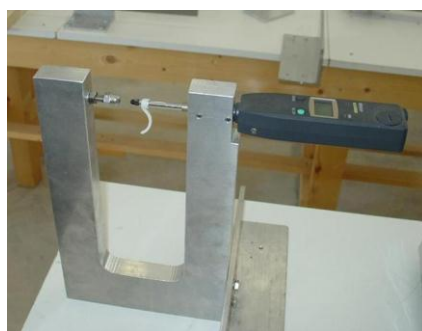

Figure I.2.2



Figure I.2.3



Figure I.2.4

For foils of even thickness, the leading and trailing edges need to be checked to ensure that the bevelling does not exceed the permitted limits.

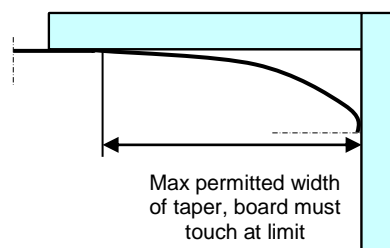

Figure I.2.5

For most dinghy and multihull classes only the profile of the immersed part of the rudder and board, as well as the maximum section thickness and edge radii or tapering is controlled. However, for keelboat classes the keel shapes are a critical factor in boat speed and are therefore carefully controlled in both shape and alignment. For the Yngling class the positions of the keel section templates are specified by distances along the leading and trailing edges from the base of the keel (despite the fact that the templates are labelled by the height above the base plane, as is the rule for the Soling Class).

In practice the two halves of the keel templates should be joined by end plates which are pinned. It is much more convenient to provide a horizontal plate on which the keel rests and then support the template at the correct height by three precision pillars. This allows the template centreline to be aligned with that of the keel, and for the front of the template to touch the leading edge. In the case of the Yngling the pillars were made so as to comply with the distances along the leading and trailing edges. This system makes it easy to align the template, which is then wedged in place for gap measurement.

Care should be taken to ensure that the gap measurement is made at the appropriate edge of the template, and ideally ball bearings of the appropriate minimum and maximum sizes should be used to test the gap.



Figure I.2.6

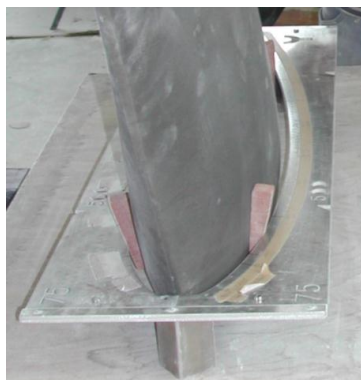

Figure I.2.7

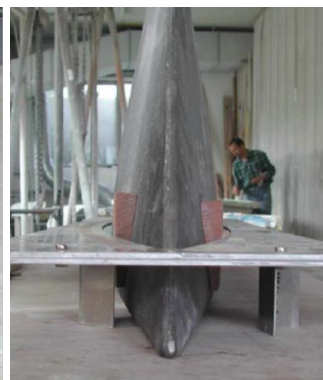

Figure I.2.8

In any case, individual sections and points may be defined on an appendage using the same principles as for hull measurement, and then thickness measurements taken directly at each point to create a data sheet when needed. Vertical sections are extended from the hull as shown below, and then horizontal ones can be marked using a surveyor's or laser level.



Figure I.2.9



Figure I.2.10

I.3 Position

For fixed appendages, the position may be controlled by a direct measurement from appropriate datum point(s) on the hull, to specific points on the appendage itself (i.e. the lowest point, or one of the corners at the bottom etc.).

For movable appendages, it may be done indirectly through a reference datum (i.e. the centreboard pivot position on hull and board, the ends of a daggerboard case on the hull etc.).

However, it is also possible to control the position of a movable appendage directly when it is positioned on the hull. The maximum extension of a centreboard below the hull is taken, as the words indicate, when the centreboard is in the position of maximum depth. This is normally, but not always, when it is in the 'fully down' position.

The measurement is most conveniently made with the boat on its side and, initially, with the centreboard in its full-down position, as follows:

- (a) Identify the lowest point on the tip of the board,
- (b) Measure the distance from that point to the nearest point on the keel,
- (c) Repeat the measurement from another point at the tip of the board if there is any doubt, about which point gives the greatest depth,
- (d) Repeat steps (a), (b) and (c) above with the centreboard slightly different positions,
- (e) The greatest measurement obtainable is the maximum extension of the centreboard.

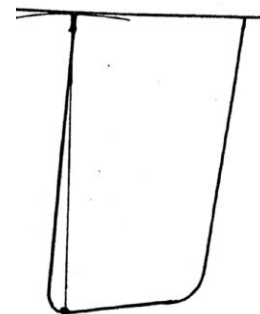

The depth of the rudder blade below the hull is normally taken in the same manner. It is -unless otherwise indicated in the class rules- the vertical distance below the lowest point of the transom, which means that the hull must be also properly levelled before.

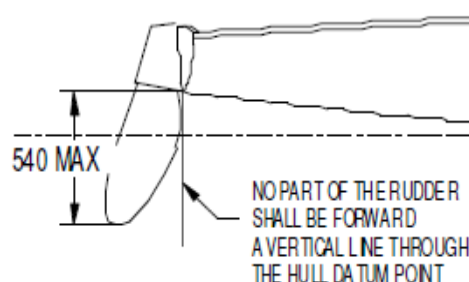

In the example to the right, class rules specify the length of the rudder when positioned on the hull as the minimum distance from the hull underside, the position of the leading edge relative to the Hull datum point, and the angle of the blade by checking the distance from the lowermost point to the HDP.

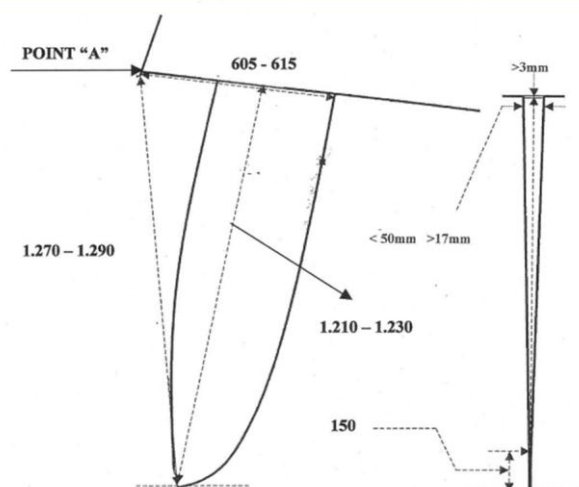

Similarly, keel fore and aft position may be controlled from the HDP, and depth from the keel line at certain stations. In some cases, this may be conveniently done with purpose made gauges as shown below.

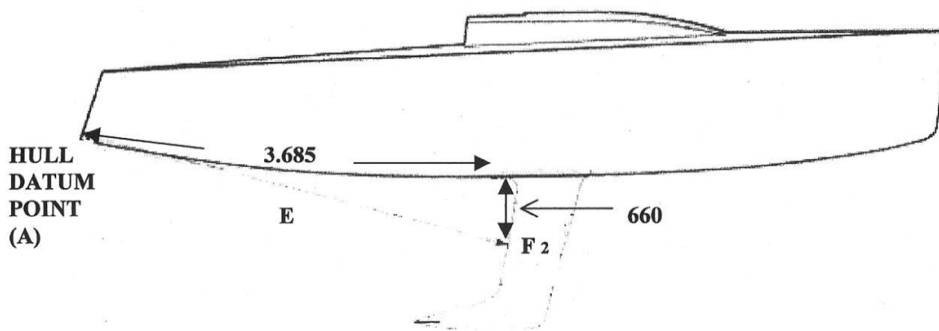

Figure I.3.1



Figure I.3.2

It may be also necessary to check the position of the pivot of a centreboard or lifting rudder. The pivot may be positioned relative to reference lines such as the leading and bottom edges of the foil. In the example below, the rudder jig has the limits of the pivot position marked with a red outline, leaving the white coloured inside to show the min/max area.



Figure I.3.3

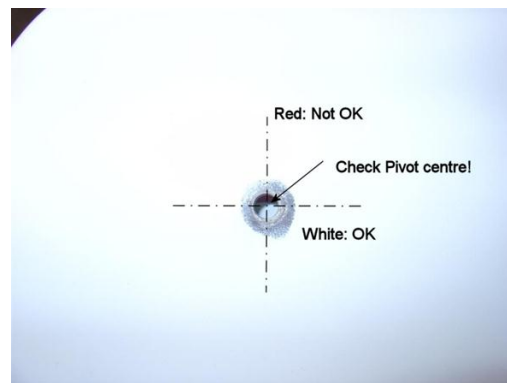

Figure I.3.4

I.4 Other controls

Appendage weight may be also specified in class rules: boards and rudders may be checked at any time using scales, but keels are usually controlled at the time of manufacture, before they are fixed on the hull. Materials are also limited in some cases so measurers should be able to identify and recognize them with a visual control. Destructive sampling should be undertaken only after consultation and permission of the appropriate certification authority.

I.5 Hull Appendage inspection at events

In most cases, inspection of hull appendages at events is carried out using the same methods as for certification measurement, especially when their shape is controlled by templates. The obvious difference is that there is no need to record actual values; therefore special go/no go templates may be constructed that only mark the limits using scribe lines or coloured areas. For example, in the case of a centreboard pivot position, one can outline the permitted positions and paint either the inside or outside area in a distinctive colour: the inspector only needs to see through the pivot hole and check that the centre is on the properly coloured area when the board is placed on the template.



Figure I.5.1 *Thickness control.*

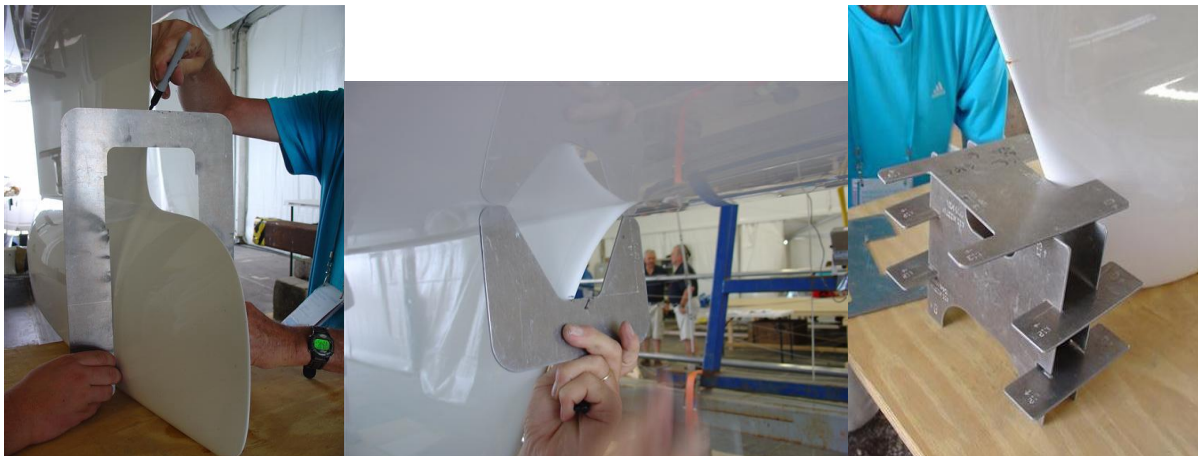

Figure I.5.2 *Section marking.*



Figure I.5.3 *Radius check.*



Figure I.5.4 *Profile check with mylar template.*



INTERNATIONAL MEASURERS' MANUAL

SECTION J

Rigs

J	Rigs	
J.1	Introduction	J 2
J.2	Spar measurement points and limit marks	J 2
J.3	Section measurements of spars	J 4
J.4	Curvature (Straightness) of spar	J 4
J.5	Weight	J 4
J.5.1	Mast centre of gravity measurement	J 5
J.5.2	Mast tip weight measurement	J 6
J.6	Deflection tests	J 8
J.7	Rigging points	J 9
J.8	Poles	J 9
J.9	ERS Rig measurement in steps	J 9
J.10	Rig Inspection at events	J 13

ERS 2013-2016 Section F provides a set of standard definitions for rigs (spars, rigging, spreaders, measurement points, dimensions and all associated fittings) facilitating uniformity in measurement methods and tools across classes. Many classes use these standard definitions and also have their class rules in the SCR format. Each of the following sub-sections deals with the main aspects of rig measurement and inspection in detail.

J.1 Introduction

The parameters that control the performance, strength and cost of a mast spar, and so are likely subjects of class rules are:

- Material, i.e. wood, the aluminium alloy and temper, carbon fibre, its modulus and resins
- The spar extrusion weight per unit length, or wall thickness
- The spar fore and aft and transverse dimensions
- The spar extrusion transverse and fore and aft areal moment of inertia
- The sail track, integral or separate
- The extent and dimensions of the mast taper
- Mast curvature and deflection
- The rigging points for stays and shrouds, spreader dimensions
- Sail hoist heights

Many of these properties are interrelated and so classes choose different combinations.

Rig measurement usually starts from the definition of measurement points: some of these are associated with limit marks which are meant to dictate proper setting of sails or other spars. Lengths –or heights when referring to masts- are then measured with reference to those points, but class rules may specify additional limitations on items such as spar section, deflection, curvature and weight, rigging specifications etc. ERS H.4 specifies conditions for measurement, which in the latest ERS cannot be modified by Class rules.

Some classes, especially those whose inventory includes more than one mast and boom such as the Finn, have rules that specify standardized dimensions; in this way spars are interchangeable, and can be measured completely independently of other parts of the boat.

J.2 Spar measurement points and limit marks

ERS specify a number of measurement points on spars: some are related to the geometry of the rig (e.g. rigging points) and others are used for setting sails or other spars. The latter are indicated by using limit marks (measurement or “black” bands). These are required to be marked distinctly (in a colour contrasting sharply with that of the spar) or even additionally engraved/punched on spars so as to be clearly visible while racing. Some classes require additional bands to indicate the positions of the forestay or spinnaker halyard.

The first measurement point on masts is called **Mast Datum Point** in ERS, and it is the datum for measurement. Other measurement points –except from the points defined on the extremities of the mast- and distances are taken with reference to the MDP. The datum point is defined in Class rules and is usually connected to one of the following:

- heel of the mast, or

- sheer, or
- deck in way of mast.

Measurement from the heel is usually referred to the heel point (ERS) but in non-ERS classes it may refer to the bearing point of the mast. A mast which has a tenon may have its bearing point either at the bottom of the tenon or on the shoulder. It may be then necessary to check the mast step in the boat. Mast datum points that refer to the heel point make measurement and inspection easier, because it is independent of the hull and the mast step fitting. However, the heel is subject to wear, so measurements taken on a new mast may change after extensive use.

If the datum for measurements is the sheerline the location of this point on the mast may be made difficult by the fact that the deck has a camber. The datum point can be found in a similar way to that indicated in section H.1.10.

ERS specify two limit marks on masts: the lower and the upper, which are associated with the lower and upper points respectively (Figure J.2.1). The upper mark is used for setting the mainsail, while the lower mark is used for setting the boom or a loose footed mainsail.



Figure J.2.1 Mast Upper and lower marks and points

The band on the boom is located with reference to the **aft face of the mast** but excluding the effects of local curvature or cut away track. This is indicated in figure J.2.2. A few non-ERS classes measure to the inside of the sail track. This is also indicated in figure J.2.3.

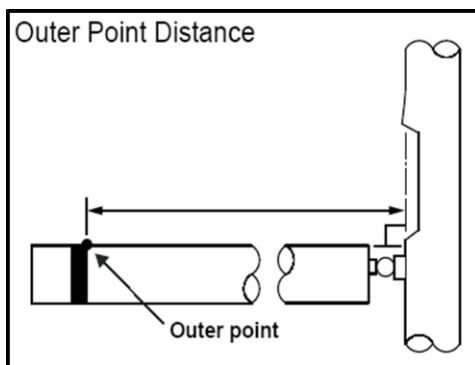

Figure J.2.2

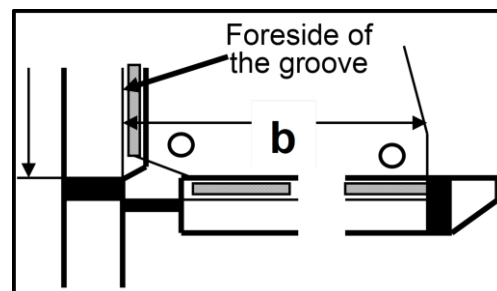

Figure J.2.3

J.3 Section measurements of spars

Most class rules include limitations on the cross section dimensions of the mast and boom. This is done either by stipulating minimum and maximum dimensions for the depth and width of the section or by stating that it shall be capable of passing through a circle of a given diameter. There are two principal ways in which the mast and boom sections are made: they are either made with the sail track integral with the main part of the section or the sail track is separate and permanently fixed on by riveting, welding or gluing. The dimensions of spar sections include the sail track unless otherwise specified (in non-ERS classes like the ACC).

Extruders of aluminium sections require relatively large tolerances and as many spar sections are designed very close to the limit of the tolerances specified in the class rules sections are sometimes found which do not comply. In view of this it is necessary to obtain very accurate measurements and therefore Vernier callipers are recommended although accurately made go/no-go gauges are suitable as well.

Some classes lay down a minimum permitted wall thickness. This usually cannot be measured except at the heel of the mast or at the open ends of a boom. It should be noted that the extrusion process can cause variations in the wall thickness so that both sides may not be the same. Accordingly, it is necessary to measure the thickness at several points. At no point is the thickness to be less than that permitted.

Most masts are tapered at their upper ends. For a number of reasons the length of the taper may be controlled as well as the size of the mast at its head. The class rules may also lay down the manner in which the taper can be made. The usual way of forming a taper is to cut a "vee" from the leading edge, closing the gap and welding together the two sides. The point at which the taper commences cannot always be determined by noting the point at which the weld commences because manufacturers sometimes add a saw cut to the bottom of the "vee" to reduce the possibility of an unsightly hollow in the profile.

J.4 Curvature (Straightness) of spar

It is a common requirement that spars are "substantially" straight. It is usual to further define this by saying that "a permanent set not exceeding X mm is permitted." This permanent set cannot be determined when the mast is on the boat because the loads applied by the rigging can temporarily distort the mast. Therefore the test is carried out with the spar lying horizontally on the ground.

A string line stretched between the upper and lower points of the mast provides a straight line from which to measure the maximum offset of the "permanent set" which is the ERS "curvature".

J.5 Weight

Decreasing either the mast weight or the height of its centre of gravity (CG) will improve the stability of the boat and hence its sail carrying capability. For a class with an all up sailing weight rule any weight saved in the mast can be put low in the hull to further improve stability. It is also much easier to right a capsized boat with a mast which is both light and has a low CG. There is also an effect of mast weight distribution on the pitch and roll response of the boat. This depends on the added moment of inertia due to the mast, which can be up to 30% of the total for pitch and even more in roll. In view of

these advantages of light low CG masts, most classes have rules to control the tendency to lighter masts, both to limit the cost, and to ensure adequately strong masts.

The way in which masts are weighed varies considerably so that it is necessary to follow precisely the requirements laid down in the class rules. Usually the mast is weighed complete with "fixed fittings". Unfortunately it is not easy to state exactly what this expression means, in view of the fact that it is interpreted in different ways in different classes. In general, anything which is bolted or riveted or welded to the mast is included under the heading of fixed fittings.

A number of classes state the weight of the extrusion which may be used to make the mast. Unless the measurer is provided with a piece of the mast extrusion he cannot determine whether the weight is correct or not. He therefore has no alternative but to assume it is correct, provided that all the other requirements with regard to section size, thickness, deflection tests and spar weight are complied with.

J.5.1 Mast center of gravity measurement

A number of classes specify the lowest acceptable position of the centre of gravity of the mast. A tip weight as specified in the ERS is required by other classes: both ways are now covered in the 2013-2016 ERS. In order to carry out the measurement of the location of the centre of gravity, the mast is prepared together with the appropriate fittings and the spar is then supported horizontally at its point of balance. The distance to the heel is then measured.

Determining the CG of a mast only requires a knife edge or inverted angle section on which to balance the mast, so sailors can easily check this themselves. For regatta inspection the knife edge is set at the minimum distance from the datum point. Then when let go the tip of legal masts must go down. This is a quick and definitive "Go-No go" test requiring no equipment and the results of which are not open to discussion. For CG location can easily be determined to within ± 3 mm. An equivalent precision of tip weight measurement for a 17 kg mast would require a tip weight precision of ± 7.5 g, i.e. an expensive 1:2000 scale. Once the CG is located it is a simple matter balancing the mast on a scale for weighing.

Prescriptions for CG measurement are shown in figure J.5.1.1. For masts with rigging the shrouds, forestay and backstay are tied to the mast spar as close to the lower point as possible with the lower ends allowed to rest on the ground (ERS H.4.7). In non ERS classes, shrouds, fore and backstay may be draped over the Knife edge, or secured by a cable tie, and the ends supported by the table. Halyard ends are also supported by the table, as in the tip weight measurement. Thus, except for the section of the shrouds etc. between the CG and the lower point this technique measures the same thing as the tip weight. In the case of an underweight mast placing the corrector weight at the knife edge will not affect the balance, placing it higher will cause the tip to go down. The required corrector can be placed on the mast and moved till the tip just descends, thus quickly optimizing its position to everyone's satisfaction.

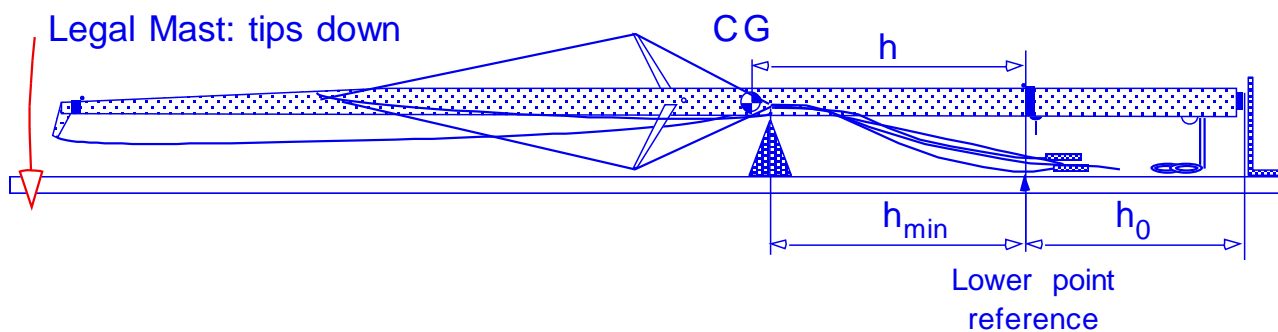

Figure J.5.1.1 Determination of the mast CG by balancing on a knife edge. For regatta inspection the knife edge is set at the minimum permitted distance from the datum point and the mast tip must go down when released.

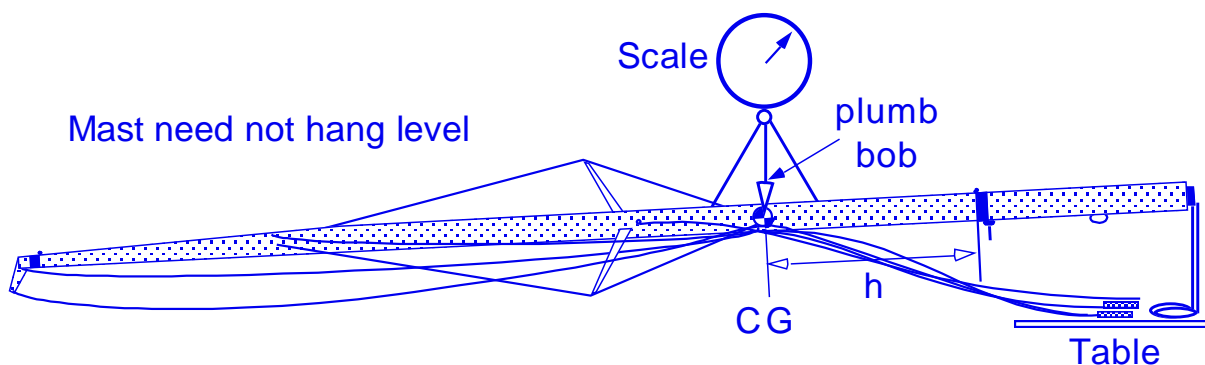

Figure J.5.1.2 Larger masts can be weighed using a hanging scale, and the CG height determined simultaneously with a plumb bob. Note that the mast need not be precisely horizontal as the CG is always directly under the free suspension point.

J.5.2 Mast tip weight measurement

To overcome the problems frequently associated with the measurement of the position of the centre of gravity, especially for bigger masts, the "tip weight" test was introduced. In this test the rigged mast is supported at the lower point and the weight of the spar at its top point taken. Halyards are fully hoisted and their tails allowed to rest on the ground. Shrouds, forestay and backstay are tied to the mast spar at the lower point with the lower ends allowed to rest on the ground.

In conducting the weight measurement the measurer has to be satisfied that any shackles etc. are of normal weight and are not being used as a means of increasing the mast or tip weight. The same remarks apply to the halyards.

It should also be pointed out that the ERS prescription for tip weight measurement, see below, means that the weight of the equipment contributing to the tip weight is NOT the same as the mast weight, because the halyard tails and shroud ends are supported for the former.

During regatta inspection, tip weight and total mast weight may be measured simultaneously using scales at the upper point and the lower point as shown in figure J.5.2.1. The halyard should be hoisted with the shackles (of less than maximum weight) at maximum height, and their (dry) tails supported on the lower point scale as they are part of the mast weight, but they shall not affect the tip weight. Spinnaker pole and other movable fittings should be at maximum height.

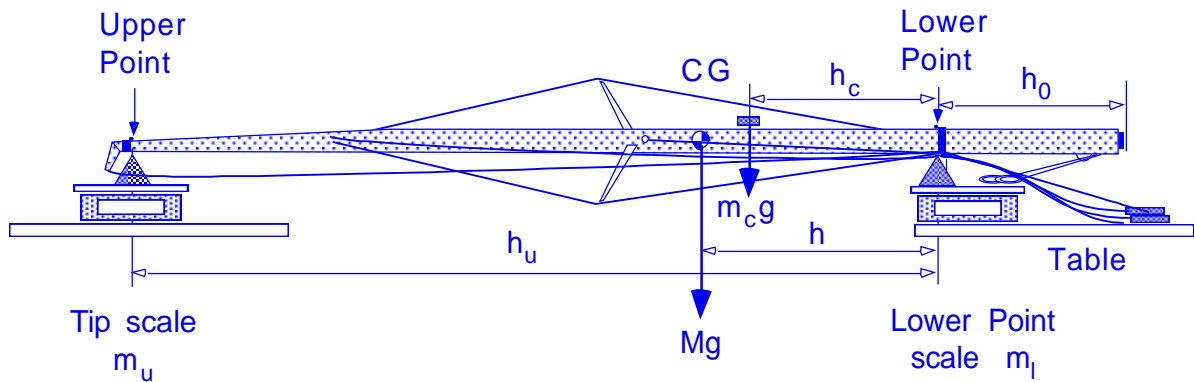

Figure J.5.2.1 Simultaneous Tip weight and mast weight measurement, with halyard tails on the lower point scale but turnbuckles supported on the table.

When the mast is below the minimum mast weight, competitors clearly want to add the minimum possible corrector weight. If the corrector is placed at the lower point it will not affect the tip weight, if placed above the lower point the tip weight will increase and the opposite will happen if it is placed below the lower point.

Both tip weight and CG height rules have to specify the conditions and procedure for measurement, which are essentially the same in both cases.

The advantages of tip weight control:

- An ERS defined procedure
- The addition of heavy fittings at or very close to the lower point has minimal effect on tip weight.
- For overweight masts a tip weight rule allows the CG height to be somewhat lower.
- For very large and heavy masts the use of two scales provides a more stable system.
- Although not necessarily optimum, most sailors accept to add corrector weight at the tip.
- Used by the Star, Sonar, 2.4M, Soling and Tornado Classes among others.

The disadvantages of tip weight are:

- Requires an additional expensive scale (to save inspection times), of resolution better than 1:2000 for precise measurement.
- Requires alignment of both the lower and upper points, and tarring of two scales.
- Requires time for the scale to settle to a stable value, and for this a protected area is needed.
- Record keeping of two readings and their sum is onerous under regatta conditions.
- Endless fiddling as sailors insist on the minimum corrector weight at the mast tip.

The advantages of CG specification:

- An ERS defined procedure
- Requires no expensive equipment.
- Is a very quick “Go-No go” test, no numbers to add or record.
- Can easily be checked by the sailor ahead of time so they arrive with legal masts.
- Easy determination of the optimum placement for any corrector weights.

- Much simpler and precise measurement for un-stayed masts.

Used by the 470, Finn, Europe, FD, Dragon and among others the RC 44, so demonstrably feasible for large masts.

The disadvantages of CG height are:

- The presence of permanently mounted heavy extraneous equipment, such as compasses, lower the combined CG, but not of course the mast CG. However, the use of demountable light electronic compasses has to a large extent obviated this problem.

J.6 Deflection tests

An important feature affecting the performance of the rig is the manner in which the mast bends under load. Some one-design classes require the mast and/or boom to have certain deflections when supported horizontally and loaded with a specified weight.

The test is carried out by supporting the mast at the upper and lower points and fixing a line between them. A point defined in class rules is then found on the spar and the distance from the line to that point measured. The weight is applied and the distance measured again. The deflection is the difference between the two measurements.

The load to be applied is specified in the class rules. It should be large enough to produce a deflection which can be measured with sufficient precision, but not so large as to be dangerous to either the mast or the measurer. It is rather cumbersome to have to bring 20kg or 50 kg weights to a regatta, however scales are usually available and a bucket can be filled with scrap iron etc., and finely tuned by adding water to provide a load. The weight of the strap and any shackles etc. for hanging the load on the mast should be allowed for. However, the deflection is proportional to the load so it is a simple matter to correct for a non-standard load. It should be remembered that when the load is hanging from the mast this is a spring mass oscillator and so it takes negligible force to displace the mast from the equilibrium position. Care should therefore be taken to ensure that no extra force is applied when the deflection measurements are made. An alternative approach, which stabilizes the mast, allows steady application of the load and overcomes this difficulty, is the use of an inverted scale with a block and tackle to a fixed point on the floor. Again it is not necessary to apply exactly the specified load as the correction is linear. At regattas this allows the load to be slowly applied and relieves the measurer from lifting the 50 kg and lowering it carefully for each mast.

There are a number of points which need to be observed carefully if the results of the test are to be accurate:

- (a) The supports have to be solid and not able to settle or move vertically when the load is applied. The supports should be narrow but if that is not possible their inner edges should be positioned at the required points.
- (b) If possible a horizontal clamp at one end should prevent the mast from rotating.
- (c) When the load is applied the ends of the mast move horizontally, so ideally one support should be on rollers. This is important for consistency with modern limber carbon surfboard masts.
- (d) The spar has to be supported with its major axis either vertical with aft edge up, or horizontal, depending on whether the fore and aft or transverse bend is being tested. If the spar rotates, the test becomes invalid.

- (e) For non-circular section masts the fore and aft bend can be half the transverse bend so the mast has a tendency to rotate, or twist as the load is applied. Not only does any significant twist invalidate the measurement, but a sudden rotation can cause shock loads which can damage the mast. It is good practice to attach a vertical pointer adjacent to the measurement point and observe that it remains vertical as the load is applied.
- (f) Measurements from the spar to the line require to be very carefully taken, typically to better than ± 0.5 mm.
- (g) When the load is removed the measurement from the spar to the line should return to the original figure. If it does not, the test must be repeated.

J.7 Rigging points

Shrouds and stays are usually attached to tangs on the outside of the mast, fixed internally or hooked into slots in the spar. The ERS specify 4 distinct situations in order to define the rigging points which are used for measuring the distances (heights) from the mast datum points.

Spinnaker hoist height is measured between the datum point and the lower edge of the spinnaker halyard when held at 90° to the spar, so in effect it is measured to the sheave or block bearing point.

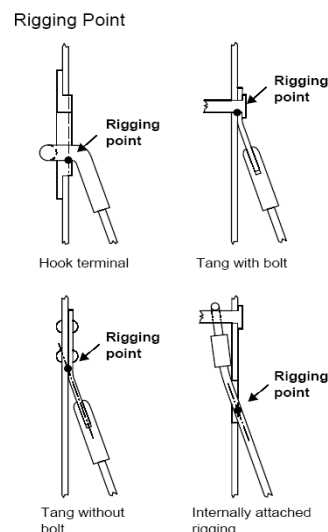

J.8 Poles

The only measurement usually required to be taken on a spinnaker pole is its length. This is the overall length (ERS) and is measured to the outer ends of the fittings, and ignores the point at which the spinnaker guy will bear. If the mast fitting for the spinnaker pole is to be measured, the height measurement is taken to the centre of the ring and the distance from the face of the mast is taken as the greatest measurement and is irrespective of the position of the bearing surface.

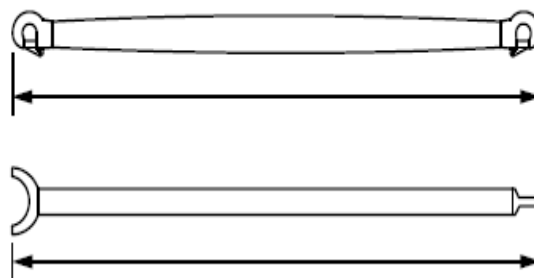

J.9 ERS Rig measurement in steps

Check the Class rules carefully!

STEP 1: FIND AND MARK the Mast Datum Point (ERS F.2.1.a)

STEP 2: MARK the other Mast measurement Points (ERS F.2.1.b-e), in most cases only the upper and lower points.

STEP 3: MARK the Rigging Points (ERS F.2.3.d-j), if relevant.

STEP 4: MARK any areas for the mast spar cross section check (ERS F.2.3.m) and the points for deflection tests if any.

STEP 5: Commence measurement of dimensions

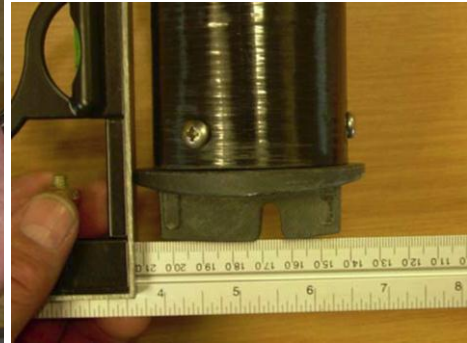
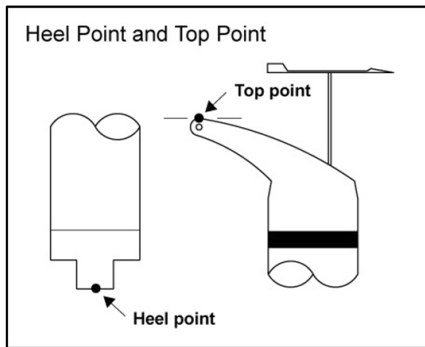

Top and heel points: In many cases, the heel point is also the mast datum point.

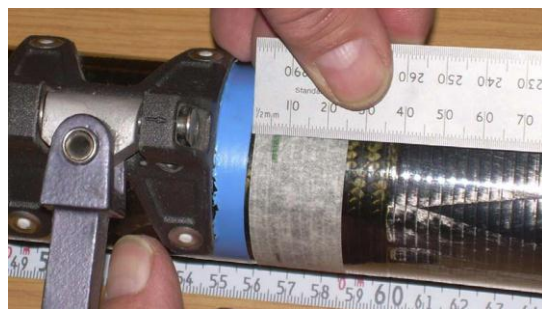
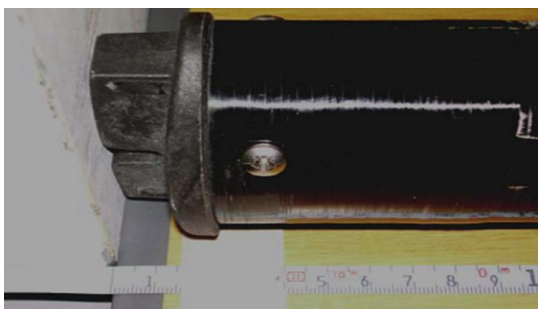

Defining measurement points: lower point from heel point as MDP.

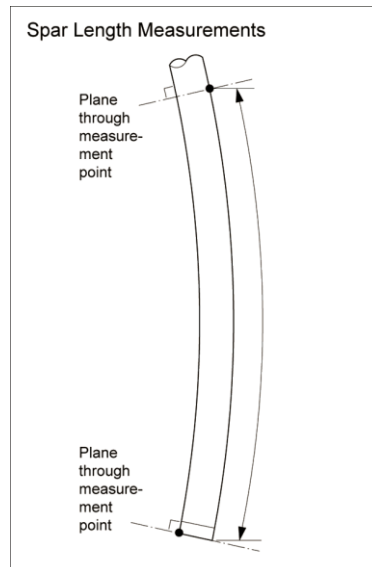

Upper point from MDP. Spar length measurements are to be taken along the spar (ERS H.4.1) so any curvature on the spar must be followed closely.

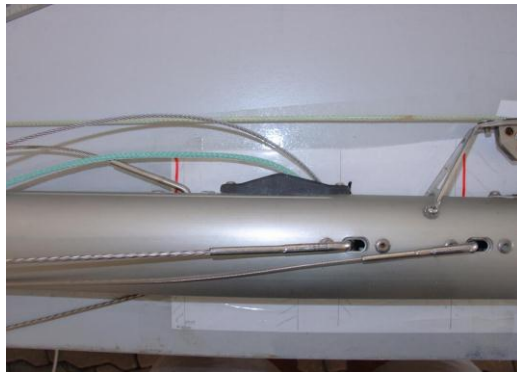

Rigging points: shroud, forestay, trapeze. Heights to be measured from MDP.

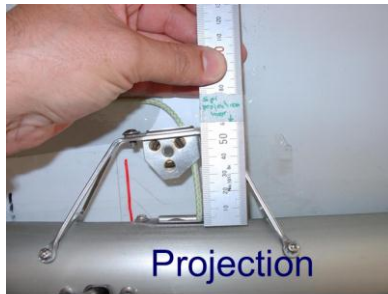

Spinnaker hoist height with the halyard at 90° to the spar.

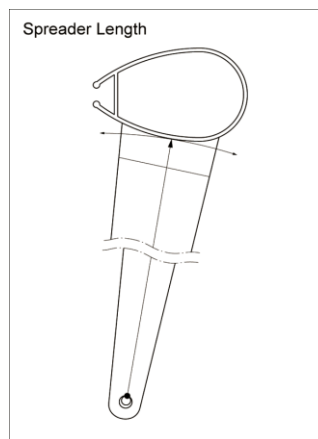
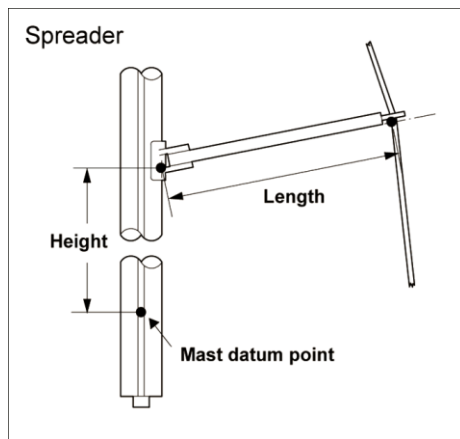

Spreader height and length measurement.

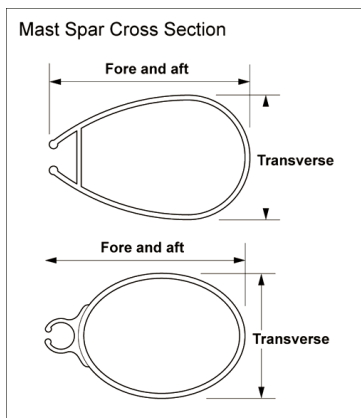

Spar section measurement.



Mast weight / centre of gravity (left) and tip weight (right) measurement. The centre of gravity may be checked using a knife-edge to balance the mast.

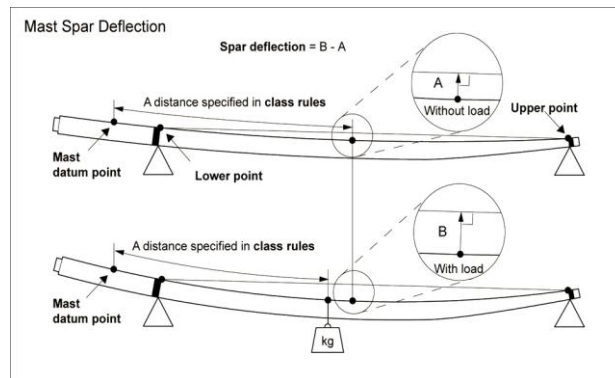
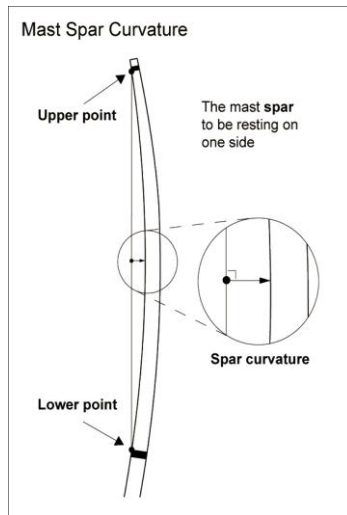

Mast spar curvature and deflection tests.

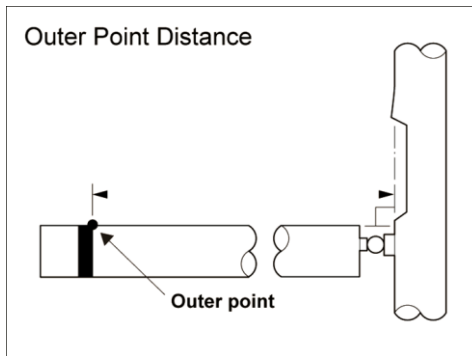

Boom measurement: Outer point distance from mast spar. The lower point defines the lowermost permitted position of the upper surface of the boom: In the example above the boom is improperly positioned with the top of the spar lower than the lower point. Under the ERS, boom measurement has to be done with the boom connected to the mast to minimize errors!

J.10 Rig Inspection at events

Event inspection for dinghy rigs is better performed on purposely built tables, using marks for minimum and maximum limits instead of tape measures. This is impossible for larger boats which have to be inspected with the same methods as for certification measurement, using tape measures and properly trained people.

A rig inspection table should have a flat, clean surface, preferably of melamine; its length should be enough to accommodate fully a mast inside, and wide enough for any required accessories like a scale to fit on top. A second table for the boom has to be fitted perpendicularly to the mast table (both must have the same height!) and this has to be wide enough to accommodate both the boom and spinnaker pole. If the boom is to be measured separately from the mast, then one table is enough for everything. Such a setup may be prepared as follows:

Mast table

- A reference line has to be drawn lengthwise: that will be the reference for the positioning of the sail track edge of the spar and the height/length measurements.
- The datum point marked on the reference line (better if it is the heel point)
- Measurement and rigging points marked on the reference line
- Spar stoppers/guides fixed on the reference line above the below the spreader position (or at two points above the boom if there is no spreader)
- Datum point stopper fixed (a strong angle)
- Mark lines drawn at the measurement points and covered for protection with clear tape.

Boom table

- Reference line drawn perpendicular to the mast reference line at the lower point position.
- Outer point marked on the reference and a line drawn and covered.
- Second line drawn for the pole. Zero point and maximum length point marked.
- Stoppers (e.g. strong angles) fixed at both points.

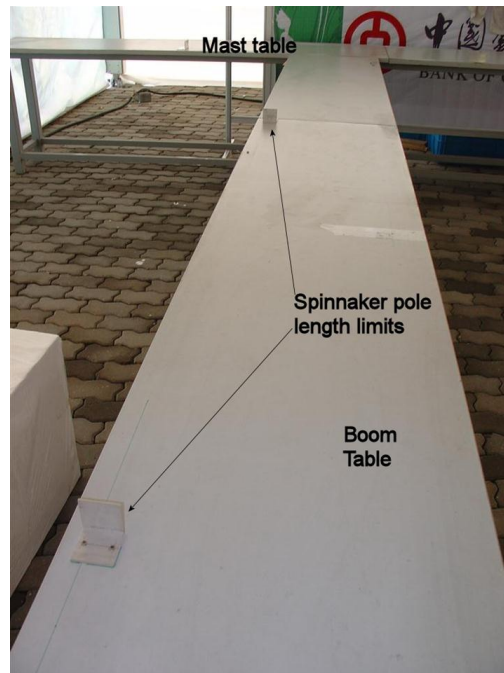
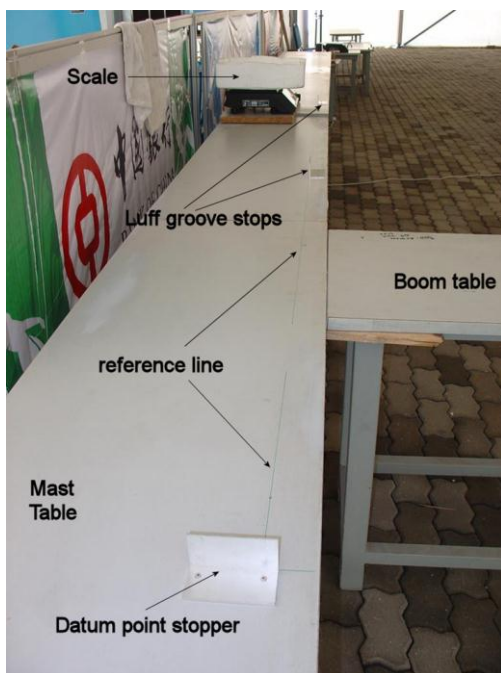

Mast and boom table layout: A strong fitting fixed securely on the table is required for setting the mast heel especially if this is the datum point. Whatever system is used, its mast heel bearing surface should be vertical and perpendicular to the line of measurement.



If the mast has spreaders, a cut-out or separation of the table is necessary for the mast to sit properly. The same should happen if the masts have fittings, compass brackets etc. that will prohibit their proper alignment on the table. Rigging and other measurement point mark lines should be color-coded and protected. A scale with proper cradle should be positioned near the centre of gravity (if checking the mast weight) or at the top if doing tip weight checks. Centre of gravity checks may be done using knife-edges as shown below. For unstayed masts, hanging scales are most convenient provided they have a spread hook to allow quick balancing of the mast.

Special tools are needed for mast spar alignment such as the cylindrical fittings shown to the right, or even simple aluminium square sections.

Go-no go gauges should be used for checking spar section dimensions.



Use of a rig inspection table:



The mast heel must be pushed and kept firmly against the datum stopper. The spar has to be also kept tightly against the two stoppers on the mast reference line.



If there is a spreader cut-out, a reference point should be marked on the table before the cut to serve as a spreader height datum. Rigging height marks should be extended to be visible both from the fore and aft edges of the spar.

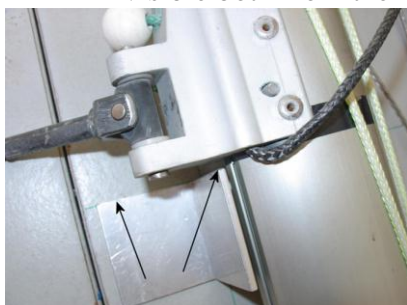

Marks on the table should be projected on the spars with a square, never eye-balled.



Knife edge used to check the centre of gravity position. It is positioned at the centre of gravity limit (usually only a minimum distance from the heel) and the mast tip should touch down when the mast is placed on the edge. Go/no go gages used to check the cross sections.

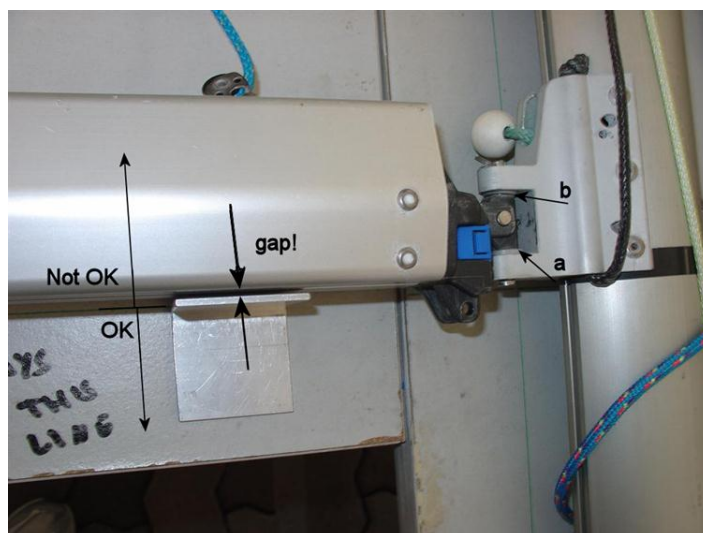

With the boom and mast joined together, the boom position relative to the lower point may be checked: the top surface of the boom (bottom in the picture above) must be at the same height as the lower point or higher. The visible gap in the picture indicates that the boom is improperly positioned.



The position of event limitation marks (usually stickers) is also important, because the stickers have to be visible on the water, but also protected from wear and tear. They have to be positioned at the same place on all boats so that the inspectors know where to expect to find them.



INTERNATIONAL MEASURERS' MANUAL

SECTION K

Sails

K	Sails	
K.1	Sail Construction	K 2
K.1.1	Types of ply	K 2
K.1.2	Ply weight / thickness	K 3
K.1.3	Sail materials	K 8
K.1.4	Fibres found in Sail materials	K 11
K.1.5	Methods of Sail manufacture	K 16
K.1.6	Glossary (of Sail Material Terms)	K 18
K.2	Sail dimensions measurement	K 19
K.2.1	Corner measurement points (ERS G.4)	K 19
K.2.2	Sail edge measurement points (ERS G.5)	K 21
K.2.3	Primary sail dimensions (ERS G.7)	K 23
K.2.4	Other Sail Dimensions (ERS G.8)	K 26
K.2.5	Additional Sail Controls	K 29
K.2.6	Identification on Sails	K 29
K.2.7	Advertising on Sails	K 31
K.2.8	Certification marks on Sails	K 32
K.2.9	Non-standard sail measurement examples	K 33
K.3	Inspection of Sails	K 38
K.3.1	Sail Table Preparation	K 38
K.3.2	Sail Table Application	K 43
K.4	Sail Area Measurement	K 44
K.4.1	General	K 44
K.4.2	Sail Area measurement instructions	K 44
K.4.2.1	Preliminary remarks	K 45
K.4.2.2	Spars and Wing Sails	K 45
K.4.2.3	Soft sails set on Spars	K 46
K.4.2.4	Soft sails not set on Spars	K 48
K.4.2.5	Sails of unusual shape	K 49
K.4.2.6	Spinnakers	K 49
K.4.3	Recording Measurements and Calculations	K 49
K.4.4	Test Case: Moth Sail Measurement	K 49

The ERS 2013-2016 offer a well-developed standard set of definitions for sails, covering terms, measurement points and dimensions so uniformity in measurement methods is possible. A lot of classes follow this system to control

- *Sail construction (including materials)*
- *Sail shape (primary and other dimensions)*

This section deals mainly with sail measurement according to the current ERS methods.

K.1 Sail Construction

K.1.1 Types of ply

A ply is a sheet of sail material, which can be made up of one or more lamina. For example a layer of film bonded to a woven fabric is a ply; in fact a laminated ply, made of two layers. A sail with its body made from one sheet of this ply would be a single-ply sail. If two sheets of the material were used next to each other this would be a two-ply sail. The word ply is both singular and plural. If class rules give no restriction as to the number of ply that may be used, it can be assumed that the number is optional. The term “ply” also covers window material.

Woven ply is the ply which when torn can be separated into fibres without leaving evidence of a film. A ply which comprises a woven base on which a plastic film has been bonded is considered to be non-woven.

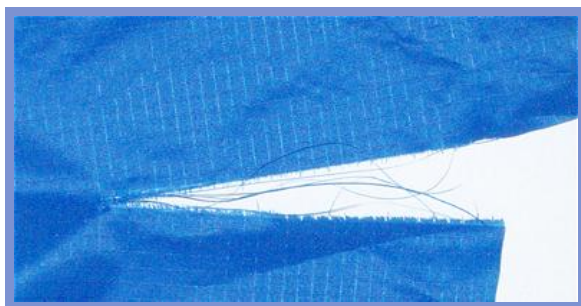

Figure K.1.1.1 *Woven ply which can be torn to show separated fibres*

It is normally quite easy to establish if a sail is soft without having to fold it and risk "damaging the ply". However, in cases of doubt, if it is claimed that the sail is soft, a measurer should fold the ply. If the measurer is unable to flatten the ply when applying pressure between forefinger and thumb or the sail suffers damage more than a crease line, then the sail is not soft.

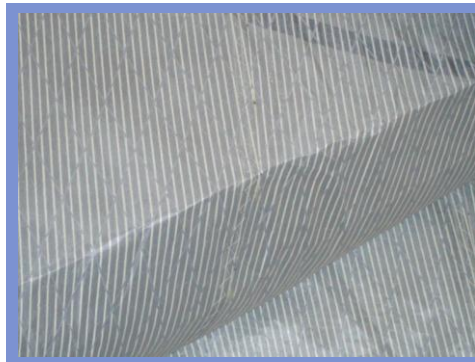

Figure K.1.1.2 *soft sail which can be folded without damage*

K.1.2 Ply weight / thickness

There are a number of classes which specify minimum ply weights. Before discussing the problems associated with such rules, it is necessary to become aware of the different units used to describe ply weight.

These are:

- ounces (oz)
- ounces per square yard (oz/sq yd)
- grams per square metre (g/m^2)

The weight in ounces (Oz) refers to the weight of one yard run of cloth 724 mm (28.5 inches) wide - this being the standard width in which the ply used to be woven and is the way in which most sailcloth is described in the United States. Table K.1.2.1 and figure K.1.2.1 show the comparison between the three units, and enable conversions to be made from one system to another.

Table K.1.2.1
Cloth weight conversion factors

Ounces	Ounces per square yard	Grams per square metre
Oz	Oz/sq yd	gsm
1 Oz	0.7917 Oz	0.02335 Oz
1.263 Oz/sq yd	1 Oz/sq yd	0.02949 Oz/sq yd
42.828 g/m^2	33.9 g/m^2	1 g/m^2

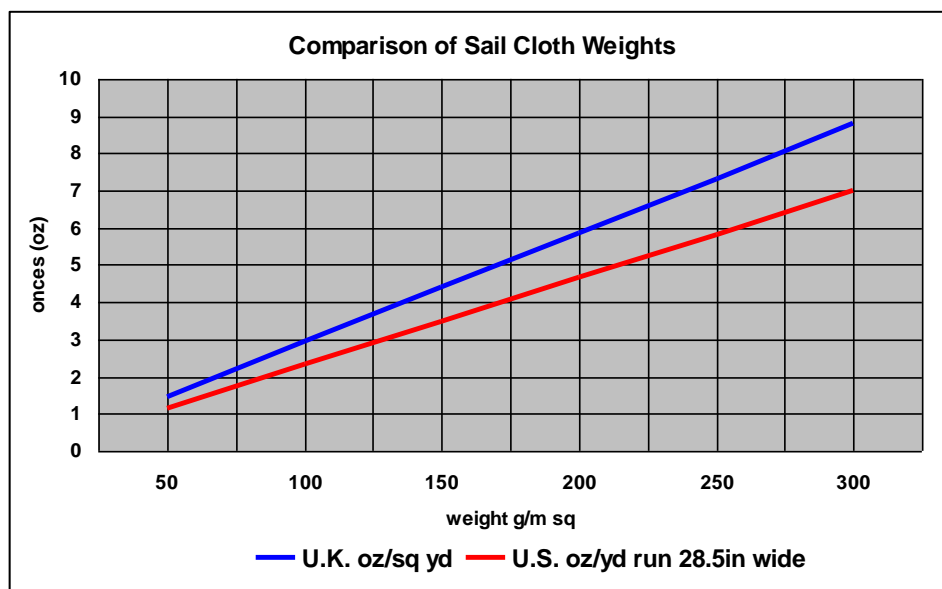

Figure K.1.2.1 Comparison of sail cloth weights

Manufacturer's Cloth weights

Manufacturers usually supply a data sheet with each batch of cloth and this includes their measurement of the weight. However this data is for production purposes and is therefore usually given to two significant figures, which may have been rounded off after unit conversion. Thus at best this data, for a 38 g/m^2 sample, is $\pm 0.5 \text{ g/m}^2$ ($\pm 1.3\%$).

Furthermore a manufacturer's quoted ply weight may be for the material before the addition of finishes therefore it is not relevant for the material as used for sails. Manufacturers are continually upgrading their products, so nominal cloth weights, which may be based on out of date data, should not be relied upon. Measurers should also be aware that sail material from a single roll might vary in thickness by up to 10%, which presumably translates into a similar cloth weight variation.

Cloth weight variation with use

Regatta inspectors are all well aware of the shrinkage of spinnakers when laid out in the sun, or put into a drier, thus there is an inherent instability in the cloth dimensions which will affect the cloth weight. Although many spinnaker materials have surface treatments to make them more slippery and hydrophobic there is nevertheless some increase in the cloth weight if it is wet. It is also likely that sails stretch with use and that the finish coat deteriorates. Thus the measured cloth weight will not be the same as that of new cloth.

It is difficult to determine whether or not a ply is in accordance with a weight control in class rules. There are two ways of undertaking this:

- determining the weight of the ply
- measuring the thickness of the ply

Weight of the ply Measurement

To determine the Weight of Ply, one needs an appropriate sample cutter and special certified laboratory scales approved to weigh samples to an accuracy of 0.01%. Five samples of ply should be accurately "die-cut" from different places in the sail, not less than 25% of the foot length apart. All five samples must be carefully placed in the draught-free compartment of a levelled laboratory scale, the scale carefully balanced, and the combined weight of the five samples read off. This weight, divided by five and corrected to the units specified in the class rules, shall be taken as the weight of the ply. Great care should be taken during the scale zeroing operation.

Thickness of the ply Measurement

Some classes control ply thickness and as there is a loose relationship between the thickness of woven ply and its weight, some classes use this to approximate ply weight by thickness measurement. There are, however, a number of factors, including closeness of the weave, the nature of the filaments and the types of finish applied, which make this relationship less than precise. This is shown by Figure K.1.2.2 which compares of woven ply weight with upper and lower limits of the folded thickness. Measurers should also be aware that sail material from a single roll might vary in thickness by up to 10%. For spinnaker cloths the change in thickness per g/m^2 is 0.003 mm, which makes it difficult to distinguish between spinnaker cloth types using a micrometre.

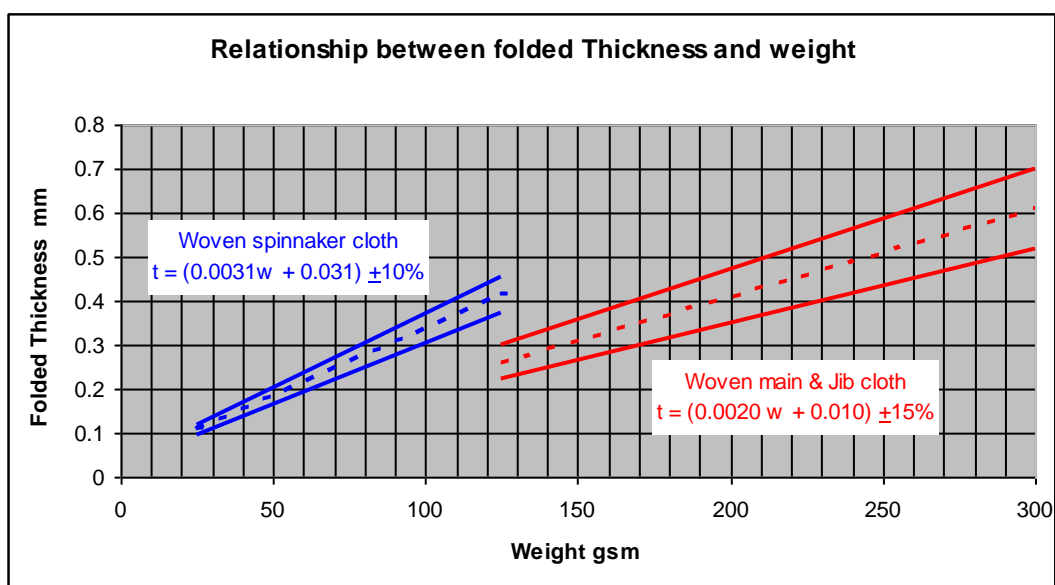

Figure K.1.2.2 Woven ply thickness vs. weight

Where class rules control ply thickness, this is usually the minimum thickness. It is thus important that measurement is taken at the thinnest area, particularly if the sail is lofted from a laminated ply with open weave scrim. If the micrometre measuring surfaces permit, thickness measurements should be taken between the scrim. The measurer should take as many thickness measurements as necessary to be satisfied that a sail is in compliance with class rules. The dimensions recorded shall be absolute and not averaged.

To measure ply thickness, one needs a micrometre and, if the ply has no scrim, a feeler gauge (Figure K.1.2.3).



Figure K.1.2.3 A digital micrometre of resolution 0.001 mm and feeler gauges for sail cloth thickness measurement

Before taking any measurements the micrometre measuring surfaces must be carefully cleaned and the micrometre itself zeroed or calibrated using the feeler gauge.

Always bring the measuring surfaces together slowly and uniformly using the micrometre ratchet when checking zero and when taking measurements.

Do not scrape the sail cloth with the micrometre while positioning for a measurement or during removal, as this may result in a resin build up on the measuring surfaces, which can cause erroneous readings.

When taking double thickness measurements, which will be necessary to measure in the body of the sail:

- (a) Fold but do not crease the sail.
- (b) Open the micrometre wide enough to enable the jaws to pass over the doubled roll without scraping.
- (c) If the ply has no scrim, place the feeler gauge between the two ply layers. This prevents the surface of one layer meshing with the other. Subtract the feeler gauge thickness from the micrometre reading.

Stiff cloth may require two or more padded clamps carefully placed near the point of measurement to hold the two layers together.

Re-check for clean measuring surfaces and zero or re-calibrate frequently, especially before re-checking measurements close to or outside specified class limits.



Figure K.1.2.3 Ply thickness measurement using a micrometre and feeler set.

With laminated sail cloth, measuring the thickness becomes increasingly more difficult and therefore it is harder to determine the weight of the cloth. In that case, a third possible method is to compare the sail against manufacturer sample sheets. In addition, some classes require the sailmakers to declare the cloth specification/type on the sail itself usually with a special stamp.

Sail Weight Rules

There are three approaches to the control of sail cloth weight have been adopted by various classes:

- Specify minimum cloth weight
- Specify minimum weight of the sail
- Adopt a list of permitted sail cloths

Cloth weight

On the face of it specifying a minimum sail cloth weight would appear simple, but applying such a rule at regatta inspection has major problems. As pointed out above thickness measurements are not precise enough, or sufficiently well correlated to cloth weight to be used for more than rough identification of different cloth types, such as in the foot of a mainsail. Cloth samples, even from the same role of cloth, can vary by up to 10% and so measuring a test sample is also not precise enough, thus only cutting five samples from the sail itself may provide definitive evidence for a Jury. Such an

intervention would require serious evidence of non-compliance, would damage the sail, possibly beyond repair, and require significant time for the samples to be sent for analysis, and so is impractical. With the advent of IHC of sails spot checks of cloth stock at the sailmakers could however be undertaken to check compliance.

Sail weight

An alternative control is to specify the weight of the whole sail, as is used by the Melges 24 class, and this has the major advantage that it can be relatively easily checked during regatta inspection. However, there are ways of increasing the weight of sails made of light cloth, without reducing the performance. These include using heavy headboards, cringles and or shackles, excessive reinforcement or tabling etc. The use of excessive cringles, or shackles would be obvious and easily compensated by requiring the competitor to bring extra such fittings for weighing. Headboards on mains and jibs are in any case usually kept to a minimum, to reduce the weight aloft, while they are not required for the spinnakers of many classes. This leaves the reinforcement which can however be limited by the class rules, and any excessive use to increase weight would largely negate the advantage of using a lighter cloth. Thus from a measurers point of view such an approach has some advantages.

The sail must be dry before weighing and inspected for any heavy fittings. The competitor shall be required to bring samples of any heavy fittings such as stainless cringles, hanks shackles etc.

For IHC it is assumed that the weight of the sail would be recorded at the tack.

Cloth type

The Tornado and Yngling classes specify a list of permitted spinnaker cloths. Such a rule requires a class, in conjunction with ISAF to have a procedure for approving the permitted sail cloths, and adding new types as they are developed. As sail cloth of a given type may vary appreciably in weight, even in one batch, by careful selection a sail maker can produce sails of significantly better performance. Even if the difference provides only a marginal advantage in boat speed, it is unfortunately the perception rather than the reality which drives sailors.

All such sails should have a stamp similar to that shown in figure K.1.2.4 certifying the type of cloth, date of manufacture and batch number, so it can be traced as cloth manufacturers provide test sheets for each batch of cloth. For such classes the regatta inspector should have a folder containing samples of all the approved sail cloths and a Lupe (Figure K.1.2.5) so that direct comparisons with the cloth in a sail can be made. Most spinnaker cloths have distinctive rip-stop patterns which can be used to identify the cloth (Figure K.1.2.6).



Sailmaker's cloth Certification

Type of Cloth

Date / / Serial No.

Name

Signed

Figure K.1.2.4 *A sample stamp for sail maker's certification of cloth type.*

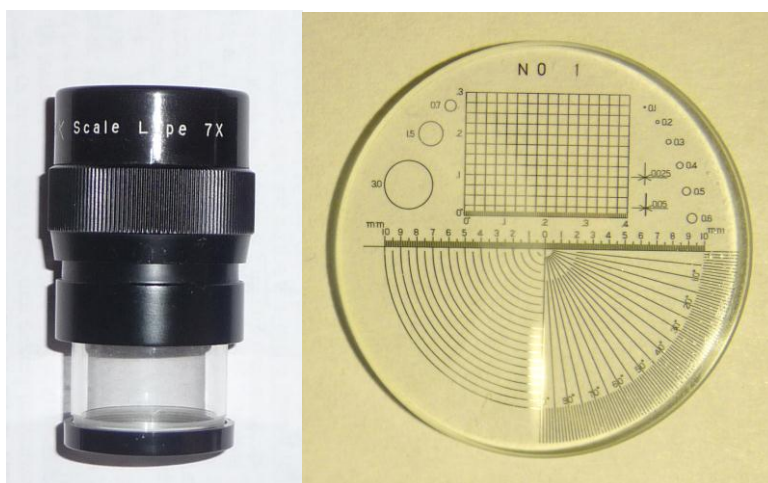

Figure K.1.2.5 An X 7 Lupe with measuring reticule for sail cloth identification.

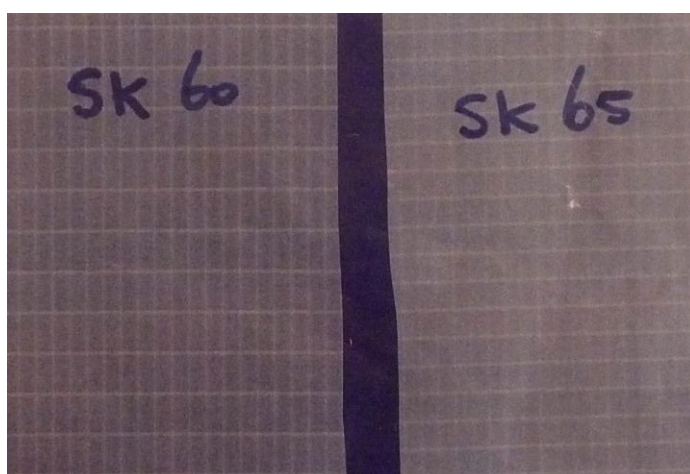

Figure K.1.2.6 Samples of two spinnaker cloths showing the different rip-stop patterns

K.1.3 Sail materials

Class rules are a means for Class Associations to limit development, control costs and therefore ensure fair and safe sailing. Where sail materials are concerned, class rules may restrict the permitted materials to be used whilst racing. As many existing class rules were written before the introduction of modern sail materials, they do not extend to the full market of materials that they are intended to cover. Below are examples of rules used to restrict wording.

“Polyester” refers to the following materials only:

Polyethylene Terephthalate (PET), Polyethylene Naphthalate (PEN) and all of the associated Trade Names including Dacron, Terylene, Teteron, Trevira, Diolene and Pentex.

Examples of some classes that refer to Polyester as the only permitted sail material are the Optimist and J-24. The essence of these class rules is to allow woven materials only and to exclude expensive high performance materials. However, Class Associations should note that Pentex is classed as a high performance polyester material that falls under the basic polyester definition.

“Aromatic polyamide” refers to the following materials only:

Poly p-phenylene terephthalamide and all of the following associated Trade names including Kevlar.

An example of a class that refers to Aromatic Polyamides is the Soling. Here the essence is to restrict the use of aramids in the class. The wording used is probably too definitive and does not include other aramids such as Twaron and Technora which are referred to as aromatic copolyamides.

“Polyamide” refers to the following materials only:

Nylon, Poly p-phenylene terphthalamide, and all of the following associated Trade names including Kevlar, Twaron and Technora.

Examples of some classes that refer to Polyamides are the Soling and the 470 Class, and this is used in reference to the spinnaker only. The wording used is too vague with many other modern materials falling into this category such as Kevlar, Twaron and Technora. It was presumably originally intended only to allow for Nylon to be used in spinnakers as well as polyester.

“Polyethylene Terephthalate” or *“PET”* refers to the following materials only:

Polyethylene terephthalate (PET) and all of the following associated Trade names including Dacron, Terelene, Teteron, Trevira and Diolene.

An example of a class that refers to PET is the J-80 Class. This is very specific wording and refers to single type of sail material.

Some classes have tried to ban certain sail material types but have used incorrect wording and “loopholes” have appeared in the rules. Some sail materials are not considered in any of the above wording, including PBO, Spectra, Dyneema, Vectran, Carbon Fibre and Cuben Fibre. To minimise the chances of misinterpretation, classes should use recommended wordings as below:

Polyethylene Terephthalate which refers to the following materials:

Polyethylene Terephthalate (PET), and the associated trade names including Dacron, Melinar, Melinex, Terelene, Teteron, Trevira and Diolene.

Polyester, which refers to the following materials:

Polyethylene Terephthalate (PET), Polyethylene Napathalate (PEN) and the associated trade names including Dacron, Melinar, Melinex, Terelene, Teteron, Trevira, Diolene and PENTEX.

Aramids, which refers to the following materials:

Poly p-phenylene terephthalamide and all of the associated trade names including Kevlar, Twaron and Technora.

High Performance Polyethylene (HPPE) which refers to the following materials:

Spectra and Dyneema and all associated types and trade names.

Liquid Crystal Polymer which refers to the following materials:

PBO and Vectran and all associated types and trade names.

Carbon Fibre which refers to the following materials:

Carbon Fibre and all associated types and trade names.

Cuben Fibre which refers to the following materials only:

Cuben Fibre and all associated types and trade names.

As there are so many different variations on the chemical structure of a fibre and so many different trade names it is very difficult to include all associated fibres without writing out a complete list.

Laminate sailcloth is when assorted layers of film, taffeta, scrim and knits are bonded (laminated) together, often using a heat process, to form a composite material.

A simple laminate consists of open scrim fibres, to take the load, with a simple film bonded to each side. However there are many different types of laminates, of which four are most popular.

The first is the Woven/Film/Woven type laminate. This consists of a loosely woven Dacron taffeta laminated to a layer of film. In this application, the film provides most of the stretch resistance and the taffeta is mainly utilized to enhance tear and abrasion resistance. A higher end version of this would be to change the Dacron taffeta for a harder wearing Kevlar or spectra taffeta.

The second is Film/Scrim/Film type laminate. This construction method has the structural fibres sandwiched between two layers of film. This way, the load bearing fibres are laid straight which takes away the effect of crimp on the cloth. When laminating film on film, the bond is very strong which allows a minimum amount of glue to be used making the cloth lighter without sacrificing strength. This, however, is the weakest type of lamination when it comes to abrasion or flex resistance. This is because the film is not as good as the woven film when it comes to flex and abrasion and also exposes the structural fibres to harmful UV rays. This type of lamination is more often used for short-lived racing sails where the life expectancy of the sail is short. Sometimes a UV film is used instead to better protect the structural fibres.

The third type of lamination is a combination of the first two. This is where a film/scrim/film laminate is bonded on each side with a woven material. This takes advantage of the bonding strength of the film on film structure, and adds flex resistance and UV protection using the taffetas used in the woven/film/woven structure. This cloth is very popular with long distance racers as it combines strength and durability in a single cloth.

The fourth and final type of lamination is Woven/Scrim/Woven, where woven materials are on both sides of the scrim with no film used. This would be the ideal type of lamination as it eliminates the film element, which is the main cause of shrinkage in sail materials. The problem with this type of laminate is that bonding two woven fabrics to each other is not easy and adding inserted yarns in the middle makes bonding even more difficult.

Film is generally made up of a polyester sheet material, otherwise known as Mylar, made by Dupont. In the early days of laminated sailcloth, the film layer was a major structural

part of the cloth. As technology progressed, the role of the film has increasingly become secondary, acting mainly to keep the fibres in place. Mylar film is made using an identical resin that is used to finish Dacron. This resin starts off as a block, which is subsequently stretched into thin sheets. Whilst being stretched, the polyester molecules are moulded in a unidirectional manner, which both stiffens and stretches the polyester. This process forces the film to behave like a woven fabric without any crimp in the warp and fill, but with some bias stretch. Film technology has progressed at the same level as the fibres, where films have different dyes to either protect the fibres from UV or to simply enhance the colour of the cloth. There is as yet no coloured film that completely solves the problem of UV degradation. Special films have been developed for PBO fibres in particular to help reduce their susceptibility to UV light.

The colour of the sail material tends to depend on the fibre. Where polyesters are concerned, they are naturally white (slightly off-white). With aramids where the fibre is more susceptible to UV degradation then the film is very often dyed to protect the fibres. Laminated Kevlar, for example, is the most popular sail material used in modern racing yachts. It is also one of the worst fibres affected by UV light. As the fibres are sandwiched between the two layers of Mylar film, this film can be dyed to help protect the fibres. The most common dye to the film is called MagnaShield. This is a dark film, which contains a UV barrier in it and has a dark, smoky colour. Another reason for dyeing the film is to simply make the cloth stand out. One sailmaker has dyed all off their laminated Kevlar cloth a bright orange so that on a busy day on the water, the sails stand out and are more noticed.

K.1.4 Fibres found in Sail materials

There are lots of different fibres that may be found in modern sail materials. However, it should be noted that in the majority of cases the fibre name is only a trade name and does not represent the actual properties of the fibre.

There are several chemical groups into which these fibres can be split. They are; **POLYESTERS, NYLONS, POLYETHYLENES** and **ARAMIDS**. Where a description is given in *italic* it is a direct quote from the Federal Trade Commission list of Rules and Regulations under the Textile Fibre Products Identification Act.

Figure 1.4.1 illustrates the different chemicals and the families they are derived from.

Figure K.1.4.1
Chemical families of fibres.

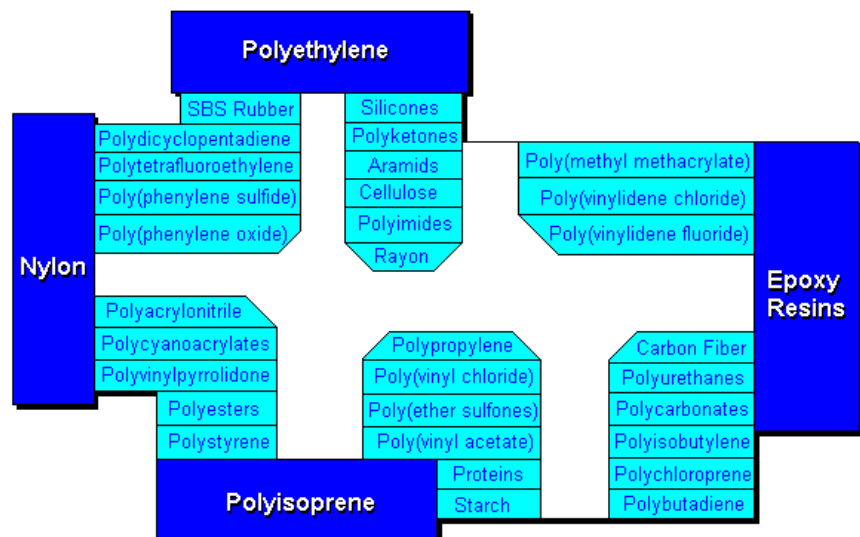

Polyester: “A manufactured fibre in which the fibre-forming substance is any long-chain synthetic polymer composed of at least 85% by weight of an ”ester” of a substituted aromatic carboxylic acid, including but not restricted to substituted terephthalate units, and para substituted hydroxyl-benzoate units.” Polyester is the most common fibre used for woven sail material. Its properties include good UV and flex resistance, as well as being relatively inexpensive. Traditionally white in colour although it can easily dyed to suit the sailmaker’s demands. A proven fibre for durability, polyester has over recent years been replaced by higher modulus fibres, such as modern aramids, for most racing applications (where class rules permit). Woven Dacron, Polyester laminates and Polyester spinnaker cloth are all products made from this versatile fibre. Polyester fibres are also called by other manufacturer’s brand names of Dacron, Terelene, Teteron, Trevira and Diolene. The standard woven polyester weave can come in two forms. The first is balanced plain weave sail material, where the warp and the fill have the same amount of crimp. This induces a tight weave which is stretchy along both the warp and the fill but not so along the bias which is held by the interlock between the fibres. The second is a highly orientated weave where the crimp is limited to the warp fibres. This produces a cloth which is stretchy along the warp and the bias but not along the fill.

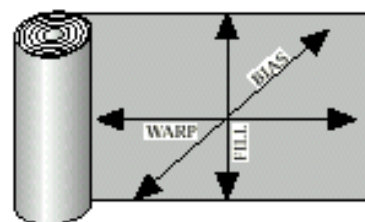

Pentex®: (polyethylene naphthalate) or PEN. PEN has twice the stretch resistance of regular Dacron polyester (PET). Pentex also offers a higher modulus alternative to that of woven Dacron’s. It is best when used in a laminate form as weaving of PEN is too expensive compared to PET. Although its modulus and stretch resistance are higher than PET, it has the same tenacity to PET and is more affected by UV degradation. This fibre is developing an impressive track record as a laminate, and is commonly found in the sails of most small offshore keelboats.

Nylon: “A manufactured fibre in which the fibre-forming substance is a long-chain synthetic polyamide in which less than 85% of the amide linkages are attached directly to two aromatic rings.” A man-made fibre used to make the traditional woven spinnaker fabric; this material is very lightweight, but not very stretch resistant. Nylon is a generic name for any long chain polyamide and very similar to Aramids. Where para-aramids such as Kevlar are ring compounds based on the structure of benzene, nylon is based on linear compounds. Due to the wide product base of nylon, there are many different variants of the base chemical. The most common type of nylon that is used in sailcloth is the type 6,6 nylon, where the first “6” indicates the number of carbon atoms in the diamide, and the second “6” indicates the number of carbon atoms in the acid. Nylon is manufactured in varying weights ranging from 0.4oz to 2.2oz. The cloth is also sometimes coated to increase performance, such as a silicon coating to reduce friction and the cloth holding water. Nylon is also more susceptible to UV and chemical degradation than polyester. As nylons uses become more varied then extra fibres are introduced into the cloth. Available from one supplier is a nylon cloth with interwoven vectran strands for a very strong storm cloth with low stretch along both the warp and the fill.

Polyester spinnaker cloth is easy to confuse with Nylon spinnaker cloth: The only real difference between polyester and nylon spinnaker cloths is the actual fibre. Physical differences are hard to see or feel. Polyester has a tighter weave, making it more stable in structure, soaks up less water and stretches less. Nylon on the other hand has more stretch to it making it easier to trim, especially in waves. Polyester, due to its low stretch, has low tear strength and can be easily ripped. A stretch test is a simple method of testing

between the two cloths. Polyester will not stretch at all under hand tension whereas nylon will have a visible, although small, amount of stretch.

Aramids: “A manufactured fibre in which the fibre-forming substance is a long-chain synthetic polyamide in which at least 85% of the amide linkages are attached directly to two aromatic rings.”

Kevlar®: (Polyphenylene terephthalamide) or PPTA/PPD-T. This is termed as an aromatic polyamide. A gold coloured aramid made by DuPont, Kevlar's modulus is five times greater than that of polyester. Of all the high modulus fibres, Kevlar has the most proven track record, mainly due to it being the most common fibre used in racing applications. It is available in both standard K-29, and high modulus K-49 fibres, with the latter being used increasingly for applications such as boat building and high performance sail manufacture. Recently other types of Kevlar such as Type 149 have been introduced. These recent introductions are primarily due to a refinement of the liquid crystalline spinning process used to manufacture Kevlar. Despite its high modulus, Kevlar is not very durable in terms of fatigue and UV resistance. It is also more expensive. Kevlar is UV sensitive and its gold colour turns brown as it is affected by sunlight. Another factor of its low UV resistance is a liability to stretch under load. This is seen in the used sails where the fibre has had its modulus reduced to half of its original form over a period of 3 months. Kevlar is more commonly being used as a hybrid material where it is mixed with fibres such as PBO or Carbon.

Technora®: This is an aromatic copolyamide and although an Aramid, is a different type of fibre to PPTA due to its chemical structure and process of manufacture. Made by the Japanese company Teijin, Technora is a high modulus fibre developed as reinforcement for drive belt applications. In sail material, it is dyed black to help its UV resistance but is also available in its original colour of gold. Technora's properties are very similar to that of Kevlar, although it has slightly better abrasion resistance; it is more expensive than Kevlar. Technora's flex resistance is almost 20% better than other para-aramids such as Kevlar and Twaron. Although once used as the primary fibre in a sail material, Technora is now seen more as bias support for higher modulus composite laminates.

Twaron®: Twaron is in the same group as Technora, where its classification is of an aromatic copolyamide. High Modulus Twaron or HMT is a fibre very similar to Kevlar and Technora in its properties of modulus and tenacity. The main difference in HMT is that its UV resistance is much higher than that of Kevlar and Technora. Originally made by Akso Nobel, the rights to HMT have recently been sold to Teijin, the maker of Technora. Like all other para-aramids, it is bright gold in colour, although due to its higher UV resistance it doesn't fade. Twaron is also used in the boat-building sector where its high absorption of energy and high modulus is a benefit to creating stiff racing hulls.

PBO Zylon®: Poly (p-phenylene-2,6-benzobisoxazole)(PBO) is a rigid-rod isotropic crystal polymer. PBO fibre is a relatively new high performance fibre developed by TOYOBO Co. PBO fibre has superior tensile strength and modulus to Aramid fibres (such as Kevlar, Technora and Twaron). It also has outstanding high flame resistance and thermal stability. PBO fibre, furthermore, shows excellent performance, in such properties as creep, chemical resistance, cut/abrasion resistance, and high temperature abrasion resistance, which far exceed para-aramid fibres. PBO is commonly used in high performance grand prix racing laminate sail material. Although a very expensive fibre, PBO creates a high performance sail material with few disadvantages. However, it does

have one major drawback. This concerns the fibres inability to resist almost all spectrums of light. Where some fibres are sensitive to UV light, PBO is sensitive to a much wider spectrum. The solution to this was to cover the fibre in an orange film which was found to be the most protective towards the fibre.

Polyethylene: Polyethylene is simply formed by the polymerization of ethylene. This is done using a catalyst to initiate the process and an accelerator to allow the reaction to take place at room temperature. There are two different types of polyethylene, LDPE and HDPE. These represent LOW Density Polyethylene and HIGH Density Polyethylene respectively. It is HDPE that is more often used in the manufacture of sail material. HDPE has a linear molecular structure where LDPE has a branched molecular structure. The linear structure is important as it makes the fibre very strong along its length where the branched structure is not as strong.

All of the fibres below are made out of HDPE which can sometimes be known as UHMW (Ultra High Modulus Weight).

Spectra®: A high modulus weight polyethylene or long chain polymer, Spectra is a product of the Allied-Signal Corporation, now known as Honeywell. Spectra has a higher modulus than most fibres, except for carbon and PBO. First used in sail materials around 1987, it was originally used instead of Kevlar but its low stretch resistance meant that it was soon discarded from racing applications. This stretch makes it difficult for the sail designer to guarantee the shapes they want after manufacture. As a result, Spectra is viewed more as a performance cruising fibre where its excellent flex, UV and chafe properties along with its traditional white colour are perfect for large cruising boats where cloth strength and durability as well as weight are considerations. Spectra is often found in laminates where it is bonded between taffeta for performance cruising sail materials.

Dyneema®: Produced by the Dutch company DSM, Dyneema, like Spectra is a highly processed polyethylene, which offers good UV resistance, high theoretical initial modulus and breaking strength. It also shares Spectra's creep characteristics. It has almost exactly the same properties as Spectra except that it is more commonly available and slightly cheaper to produce.

The method of manufacture for both Spectra and Dyneema are very much the same. In normal polyethylene the molecules are not orientated (like a branched molecular structure), and can be easily torn apart. To make strong fibres, like Spectra and Dyneema, the molecular structure needs to be orientated and crystallised in the direction of the fibre. This is why a HMPE (High Modulus Polyethylene) is used as a starting material as this is of a linear molecular structure. This is then processed using a gel-spinning process which draws the fibres out of the melt. As the fibre is drawn through the gel solution, it is disentangled and once cooled, it forms filaments. Due to the low degree of entanglement the fibres can be super drawn which straightens the structure and produces a high level of orientation. It is this orientation that defines the initial modulus of the fibre.

Vectran®: A wholly aromatic polyester-based, liquid crystal polymer fibre manufactured by Hoechst Celanese. It was first produced for the US Navy for towing arrays from submarines. Vectran has a modulus comparable to Kevlar but due to its molecular composition has better flex and abrasion resistance, although its UV properties are worse. Vectran, unlike Spectra or Dyneema, does not creep. These characteristics make Vectran an interesting candidate as a performance fibre, although it is more

expensive than either Kevlar or Spectra. Vectran is uncommon as a laminate and can normally be found as a hybrid cloth with polyester.

Certran®: A high modulus polyethylene fibre, similar to Spectra, manufactured by Hoechst Celanese. This fibre shares the same resistance to flex fatigue and UV as Spectra so its applications in sailcloth are limited to secondary fibres and areas which can take advantage of its flex, chafe and UV resistance. It is rarely used in modern sails as the price of Certran limits its use to a small percentage of the market. Due to its limited availability and cost, production of Certran has been stopped.

Carbon Fibre: Carbon has only recently been accepted into offshore classes over the past couple of years, although the fibre has been under development for over fifty. Carbon was first used during the 2000 America's Cup with varying degrees of success. Due to the many different types of manufacturing processes there are various chemical types of carbon fibre available. Carbon is originally a very brittle, but strong fibre. Its primary application was in building applications such as boats. Here its brittleness isn't such a worry as the fibre is cured with resins to form an extremely strong hull. However, when carbon fibres were first introduced into sail materials, which are constantly being folded and creased, the brittle nature of the fibre led to many failures of the sail. A lower grade fibre is now used in sail materials, which still has an exceptionally high modulus and tenacity, but also has the lowest amount of stretch of any fibre and more importantly, has a good flex life. It is also completely resistant to UV degradation making it perfect for high end racing applications. Since Carbon has become a legal sail material in Offshore Classes, its cost has dropped to that of Kevlar as the development continues to improve the fibres properties. Carbon is being used in all methods of sail manufacture where in the 3DL and TapeDrive process it is being used alongside Kevlar in a hybrid form to create a super strong, low stretch sail.

Cuben Fibre: Firstly it should be pointed out that Cuben Fibre is only a trade name and a process for manufacturing sail material. It is not a specific cloth or contains any one fibre. The Cuben Fibre Corporation claims that its fibre/film content is very similar to other laminate cloths. The fibres may vary from spectra or dyneema to aramids such as Kevlar etc. The film is a polyester film called Mylar with another similar material called Tedlar on top of everything. As Cuben Fibre can be made out of many different materials it is hard to define exactly what type of cloth it is but it is essentially a very expensive laminate. The method used to produce the cloth makes it expensive seeing that it is virtually hand made. A combination of films and fibres are laid down by hand to form the essential sandwich of the laminate. This is all then bonded under extreme pressure in an autoclave to produce a very light cloth. The autoclave itself is only 30 feet long so therefore only roll lengths of this length can be produced. This and the complex nature of the manufacturing process make Cuben Fibre the most expensive and the most demanded sailcloth on the market.

SAIL CLOTH FIBER COMPARISON CHART					
SAIL CLOTH FIBER	Initial Modulus grams/denier	Tenacity grams/denier	Flex Life % lost after 60 bend cycles	UV-Resistance 50% strength loss (months)	Elongation at Break Percentage
PBO Zylon†	1830	44	27%	2-3 months	2.5%
High Tenacity Carbon Fiber	1350	60	22%	not effected	1.2 - 1.5%
Spectra® / Dyneema®	1250	33.5	no effect	6-7 months	5.0%
Kevlar® Edge*	956	29.4	22%	2-3 months	3.0%
Kevlar® 49*	945	23.9	25%	2-3 months	1.5%
Twaron® 2200 (HMT)*	810	23.5	25%	2-3 months	1.5%
Cetran®	650	15	no effect	6-7 months	4.0%
Technora® Black	540	28.3	7%	3-4 months	4.2%
Vectran®	510	23	15%	1-2 months	2.0%
PEN Fiber (Pentex®)	250	10.2	no effect	6 months	6.0%
High Tenacity Polyester	135	7.9	no effect	6 months	8.0%
Nylon®	45	9.5	no effect	3-4 months	13%

† UV-Resistance tested with Magna Shield cover
 * ASTM 885 (American Standard Testing Method #D885)

INITIAL MODULUS: A yarn's ability to resist stretch. Higher numbers indicate less stretch.
TENACITY: A yarn's initial breaking strength. Higher numbers indicate that greater load is needed to break the fiber.
FLEX LIFE: A measure for a yarn's ability to resist flexing & folding. Lower numbers indicate less loss after 60 cycles.
UV-RESISTANCE: Amount of time it takes for a yarn to lose 50% of its initial modulus. UV tests are normally conducted with artificial UV exposure.
ELONGATION: Elongation at break is a measure of a yarn's ability to resist "shock" loads.

Data Courtesy of Dimension Polyant Sailcloth

K.1.5 Methods of Sail manufacture

Traditionally, sails have been made out of cotton. As technology has crept into the sport, the method of producing sails and the materials used have moved along with this advance in technology.

Due to this, some classes have begun to restrict the method of sail construction. For example, the Finn has the following passage in their rules: “continuous layers or fibres crossing the seams are prohibited”. This eliminates 3DL and TapeDrive as a method of manufacture but not Genesis or the D4 process.

Below are described the different methods of making sails

Panelled sails are the most common and traditional method of constructing sails. They got their name because they are made up of numerous strips of sail material (panels). Modern materials have advanced methods but there are still two distinctive methods of producing panelled sails. Though the two methods are very different, they can both be constructed using both laminate and woven materials using any fibre. The main disadvantage of the panelled process is that the load concentrates around the seams causing stretching and distortion – often at different rates from panel to panel.

Crosscut Panel Layout: A sail where all panels are parallel to each other and perpendicular to the leech. The cross cut is used mostly in the construction of Dacron or polyester sails, although modern laminates are now being marketed to suit cross cut construction. It is a popular method as it is very simple, minimises cloth wastage and allows sail makers a better control over shape as there are broad shaped seams. As the

panels are perpendicular to the leech, the cloth needs to be of a fill-oriented variety. This is mainly because the highest loads in a sail are found along the leech and the tack of the sail. A highly orientated polyester cloth is best used for the cross cut layout.

Radial Panel layout: Radial sails are made with long, thin triangular panels or “gores”. These panels are aligned along the primary load paths of the sail by lining up the warp thread of the laminate. In order to match up the warp along the load paths more accurately the gores need to be very narrow. Wider gores are used in low load areas, allowing the cloth to be more economically used. As there are more panels, different weights of cloth can be used to accommodate the different loads in the sail. Heavier cloths would be used along the leech and the tack where a taffeta-coated cloth would be used along the foot to accommodate the chafing of the sail over the lifelines.

In the construction of the sail, the gores radiate out of the corners of the sail because loads start from a corner of the sail and then run in arcs through the sail. Joining both types of panel layouts is done in a variety of methods, the most traditional being stitching. Since the introduction of laminates, joining methods have developed to incorporate the new demands. Most laminate sails are now bonded using an adhesive. Where before a light adhesive was used to hold the sail temporarily together until it was sewn, modern adhesives are much stronger and are relied on to hold the sail together for the duration of the sails life. The downside to all types of methods is that the seams slip under the sustained load, which occurs in the sail. This causes the sail to distort and lose its preferred shape.

3DLtm is a very high tech process that is dominating the world of top-level racing. The sail starts off as a CAD design which is the sails flying shape or “mould”. This data is translated into information for an articulated mould that assumes the designed shape. A sheet of Mylar film is then laid over the mould and tensioned. An overhead arm carrying the sails fibres then crosses over the sail in a predetermined pattern that precisely matches the anticipated loads in the sail. Once the fibres have been laid a second sheet of film is laid over the top of the skin, where a vacuum is then placed onto the skin to compress the laminate into a single skin. The fibre-laying arm is then changed to a heating element, which then passes over the whole sail curing the final laminate to form a very strong bond between the two skins.

Tape Drivetm is a similar but less complicated process. Here, a skin is produced of light sail material, which is stuck together in a crosscut fashion. This skin takes the shape of the sail and is not designed to take much of the load. Tapes are then laid by hand onto the skin in a pre-designed pattern to take the load. Each tape has only one individual strand, which comes in a variety of fibres and weights. This process also allows the sail to have mixed fibres which form a hybrid sail. Tape Drive is different to all of the other processes as the load-bearing fibres are on the outside of the sail instead of being laminated into the sail or sail material. Tape Drive is sometimes referred to as a moulded sail as it involves a different method of construction to a conventional panelled sail. As with all the other processes, the combination of base material, tape material and tape alignment defines the finished product.

Genesis: This process is a combination of both panelled and moulded sail making. The sail is constructed up of panels which are joined together in a crosscut panel layout. However, each individual panel has its own fibre layout and is laminated individually. Once all of the panels have been constructed the panels are then joined together and are bonded into one piece to form the finished sail. Shape is not put into the panels but into the seams, very much the same way as a normal cross cut sail. However, this process

differs to both 3DL and the Tape Drive as the fibres stop at each panel. This creates the problems that occur within a panelled sail, which is the issue of seam slippage.

D4: D4 is the latest method of sail making construction to be introduced. D4 uses very much the same technology as Genesis except that the panels are larger. The panels are individually constructed in the same method as in Genesis and do not carry any of the sails shape. The sail is then joined together, bonded, to form the final sail. The shape is again put into the sail using the joining seams in the sail. As the sections are larger there are fewer seams, which means the chance of seam slippage and sail distortion is smaller. Although D4 is marketed as a moulded sail it is, like Genesis, essentially a panelled sail (with moulded sections). The same bonding and curing process that is described in the 3DL method is used for making the panels in Genesis and D4 panels.

With all of the moulded sails there are lots of choices of fibres and films that can be used to suit the customers' requirements from the sail.

K.1.6 Glossary (of Sail Material Terms)

Aspect Ratio The luff length divided by the foot length is the final aspect ratio of the sail. A tall, thin sail has a high aspect ratio.

Bias Diagonal at 45 degrees across the warp and the fill.

Count The number of yarns per inch in either the warp or the fill of the cloth.

Creep The amount a fibre gradually stretches under constant load.

Crimp The length added to a yarn when it is woven over-and-under a piece of fabric. A tight weave will have less crimp than a more open weave.

Denier The coding system for filament yarns and fibres. A low denier indicates a fine yarn where a high denier is a heavier, thicker yarn.

Elongation The difference a sample of fabric has stretched from its original form.

Fill The fibres running at right angles to the warp, usually across the cloth.

Flex Strength The ability of a fibre to resist flex movement and retain its original strength. Measured as a percentage of its original modulus.

Hand The softness or firmness of the fabric.

Modulus Is referred to as Modulus of Elasticity. This is the measure of stretch or elasticity of a fabric, where a high modulus is equivalent to low stretch.

Stretch Resistance The ability for a fabric to resist stretch over a period of time under sustained load.

Taffeta An unfinished fabric employed as a covering, usually in laminate sailcloth, often enhancing durability and abrasion resistance.

Tenacity The breaking strength of a yarn or fabric stated in force per unit of the cross-sectional area.

Tensile Strength The ability of a fibre, yarn or fabric to resist breaking under tension.

Threadline The direction of the yarns.

UV Resistance Measure of the effect of sunlight on cloth. UV Resistance is usually expressed in the time taken for a material exposed to sunlight to lose half of its breaking strength.

Warp The yarn or fibre running along the length of the fabric.

K.2 Sail dimensions measurement

ERS H.5.1 gives the conditions for sail measurement, specifying that sails shall:

- be dry
- not be attached to spars or rigging
- unless the **class rules** prescribe otherwise, have all battens removed
- have pockets of any type flattened out
- have just sufficient tension applied to remove wrinkles across the line of the measurement being taken, and
- have only one measurement taken at a time

There are cases where battens are permitted by the class rules to be in place during measurement: jibs with straight leeches and short battens like in the 420 & 470 Classes are one example, but it can also apply to mainsails as in the Finn Class.

The ERS method follows a logical step by step approach to sail measurement. There is no need to specify a single datum point as in spars and hulls, but 3 or 4 corner measurement points, for trilateral or quadrilateral sails respectively. These points are then used for sail edge length measurement, and to define other measurement points on the sail edges themselves. In addition, there are other measurements independent of those points, for items such as batten pockets or reinforcements, and these are taken directly on each item.

K.2.1 Corner measurement points (ERS G.4)

The clew point is the intersection of the foot and the leech, each extended as necessary. Placing and bending a batten along the edge can often help to give an extension line continuing a curve, in cases where the extension is not obvious because of a cut-out (Figure K.2.1.1a) or an abrupt change in the curve radius near the sail corner (Figure K.2.1.1b).

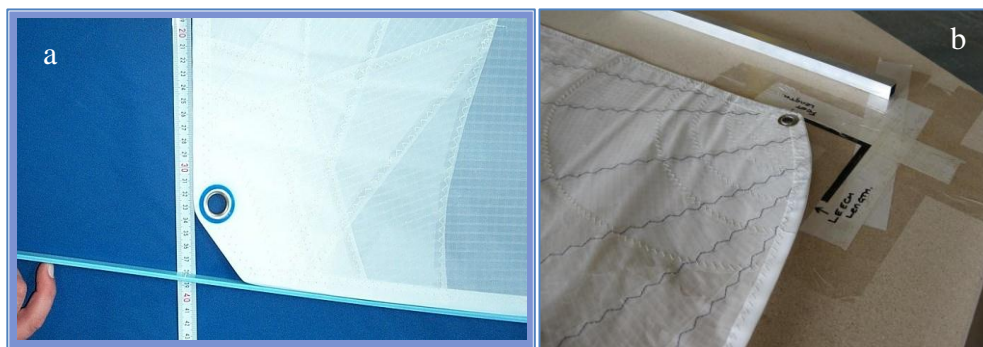

Figure K.2.1.1 *Clew point definition.*

Marking the extension lines on paper taped to the underside of the sail helps to retain the point during measurement (Figure K.2.1.2).

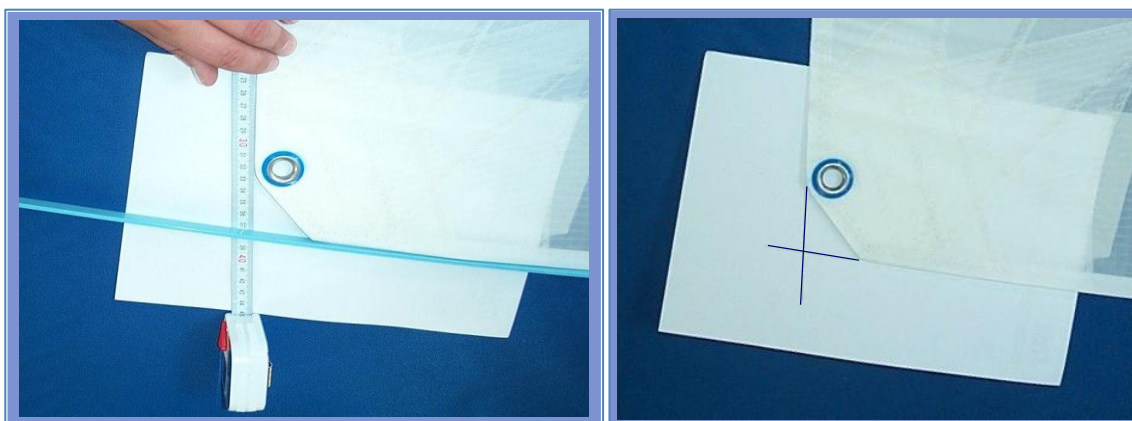

Figure K.2.1.2 Clew point marked on paper.

The tack point is the intersection of the foot and the luff, each extended as necessary, as in the case of the clew point (Figure K.2.1.3).



Figure K.2.1.3 Tack points.

In all cases, it is important to extend only the part of the sail edge close to the corner: using a very long batten in a small sail may lead the measurer to extend the straighter middle part of a jib foot and not the curved part near the corner: Figure 2.1.4.a gives such an example, on a sail that has a smoothly curved foot edge near the corner and a straight middle part, and only needs a short extension to account for the cut-out luff wire tabling (Figure 2.1.4 b).

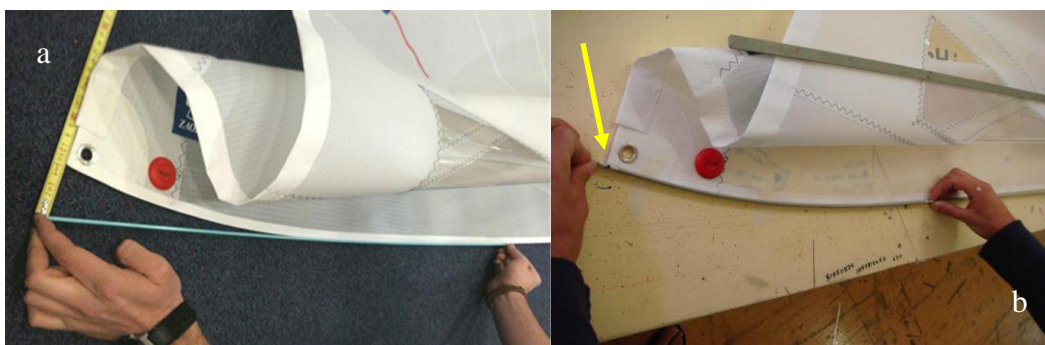

Figure K.2.1.4 a&b: Extending the foot edge with batten.

Measurers must always remember that the ERS **sail corner measurement point** definitions are not intended to introduce a sail edge shape restriction and do not require the part of a sail edge to be extended to have a specific shape. In the case of a **foot**, the

ERS provide the **foot irregularity** and **foot median** definitions that a class may use to control sail area and shape.

When the line of the extension of the edge is uncertain and not repeatable, leading to inconsistent measurement points, the measurement of the sail should be refused.

The head point on a mainsail is the intersection of the luff, extended as necessary, and the line through the highest point of the sail at 90° to the luff. In this case, any attachments are to be included (Figure K.2.1.5)

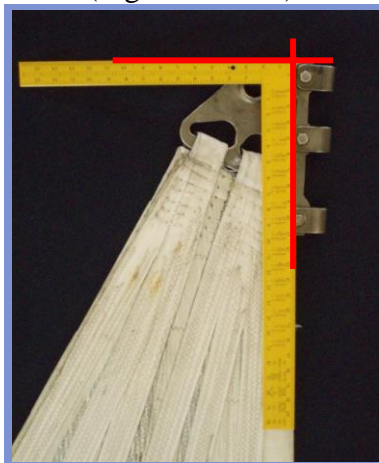

Figure K.2.1.5 *Mainsail head point.*

On headsails, the head point is the intersection of the luff, extended as necessary, and the line through the highest point of the sail at 90° to the luff but in this case excluding attachments (Figure K.2.1.6)

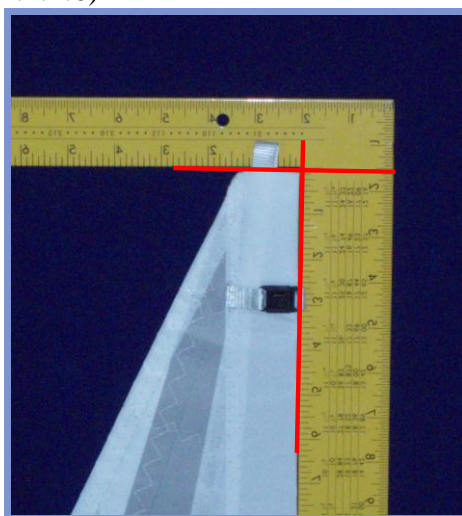

Figure K.2.1.6 *Headsail head point.*

On spinnakers, the head point is the intersection of the luff and leech, each extended as necessary, in the same way as for the clew and tack points.

K.2.2 Sail edge measurement points (ERS G.5)

The half leech point is found by folding the head point to the clew point (Figure K.2.2.1-1) and equally tensioning the two halves of the leech so formed (Figure K.2.2.1-2). The half leech point is the intersection of the fold and the leech (Figure K.2.2.1-3).

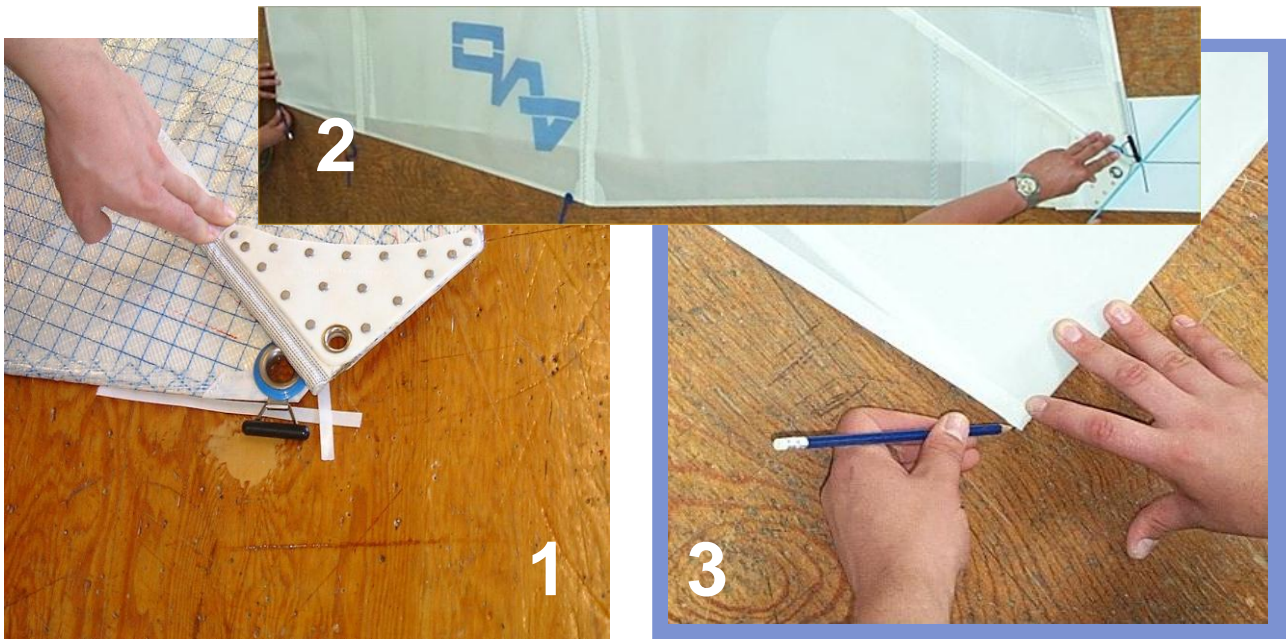

Figure K.2.2.1 *Half leech point.*

The quarter (Figure K.2.2.2) and three-quarter points are found similarly by folding the clew point and the head point respectively to the half leech point. The points are the respective intersections of the folds and the leech.



Figure K.2.2.2 *Quarter leech point.*

For upper point marking, the head of the sail should be flattened and tensioned to remove wrinkles, and then the specified distance measured with a tape from the head point to the leech and marked on the leech. A number of Classes are controlling their mainsail widths at one or more “upper points” and ignore the ERS half and quarter points. The relative merits of this system are described in K.2.9.

The same technique is used to find and mark measurement points on the luff, using the tack point instead of the clew, and also on the foot, where the mid foot point is found by folding the sail with the clew point on top of the tack point or in the case of spinnakers, one clew point to the other clew point (Figure K.2.2.3)



Figure K.2.2.3 *Spinnaker mid foot point.*

K.2.3 Primary sail dimensions (ERS G.7)

Having defined the various corner and edge measurement points, the next step is to measure primary dimensions such as lengths and widths. Sails are to be flattened as prescribed by ERS H.5.1 (Figures K.2.3.1 to K.2.3.3) by laying them out on a flat surface and then by folding or flaking them, and with just sufficient tension applied to remove wrinkles across the line of the measurement being taken (Figure K.2.3.4). The latter is especially important in spinnaker measurement, to avoid stretching the sail.

When checking sail leeches for not being convex it is vital to flake the sail, as shown in figure K.2.3.1 as this can change the leech from appearing convex to being concave. It is also important to flake the sail when measuring luff perpendiculars on full jibs see figure K.2.3.6.



Figures K.2.3.1 & K.2.3.2 *Leech flattening before and after flaking.*



Figure K.2.3.3 *Leech hollow before and after flaking.*

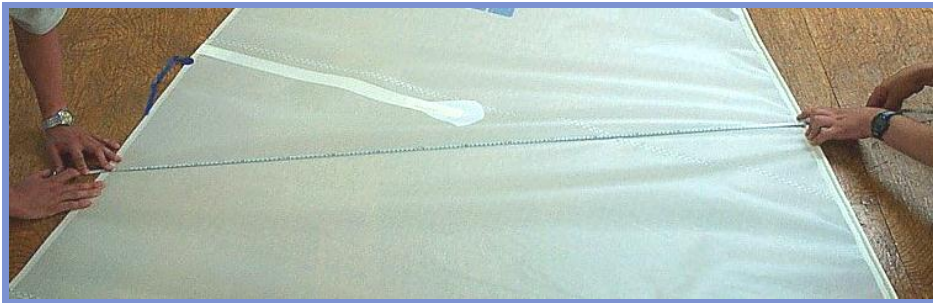

Figure K.2.3.4 *Proper tensioning of sail for wrinkle removal.*

All lengths shall be measured as the straight line distance as defined: for example, leech lengths between the head point and clew point (Figure 2.3.2 on a headsail), spinnaker foot median between head point and mid foot point (Figure K.2.3.7). Corner reinforcements which cannot be "straightened" at the head of the spinnaker may necessitate the taking of two part measurements to an intermediate point, with the sum of these giving the dimension of the defined measurement (spinnaker foot median, Figure K.2.3.5).

The luff perpendicular shall be measured as the shortest straight line distance swung across the sail by a tape from the clew point to the luff as appropriate, including bolt rope if any (Figure K.2.3.6).



Figure K.2.3.5

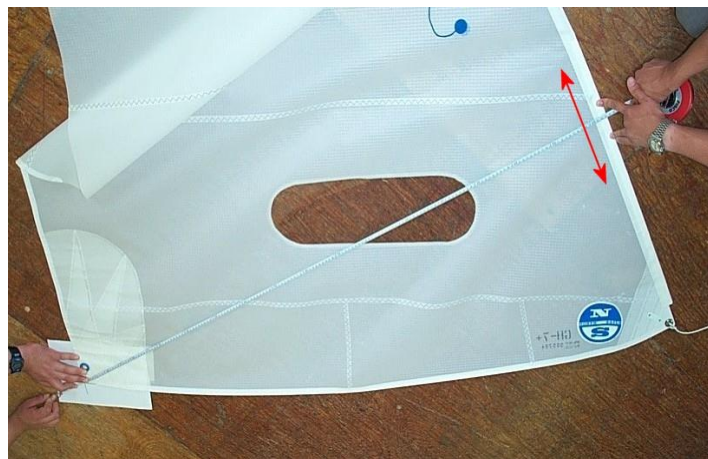

Figure K.2.3.6 *Luff perpendicular.*



Figure K.2.3.7 *Spinnaker foot median.*

Mainsail and headsail widths, except top width, shall be measured as the shortest straight line distance swung across the sail by a tape from the leech point to the luff including bolt rope if any (mainsail half width example in Figure K.2.3.8).



Figure K.2.3.8 *Mainsail half width.*

ERS H.5.2 states that when there is a sail edge hollow and a measurement point falls in the hollow;

- between adjacent batten pockets;
- between the aft head point and adjacent batten pocket;
- between the clew point and adjacent batten pocket
- between the tack point and adjacent batten pocket
- at an attachment;

the sail shall be flattened out in the area of the sail edge, the sail edge hollow shall be bridged by a straight line and the shortest distance “A” from the measurement point to the straight line shall be measured. This distance shall be added to the measurement being taken (Figure K.2.3.9).

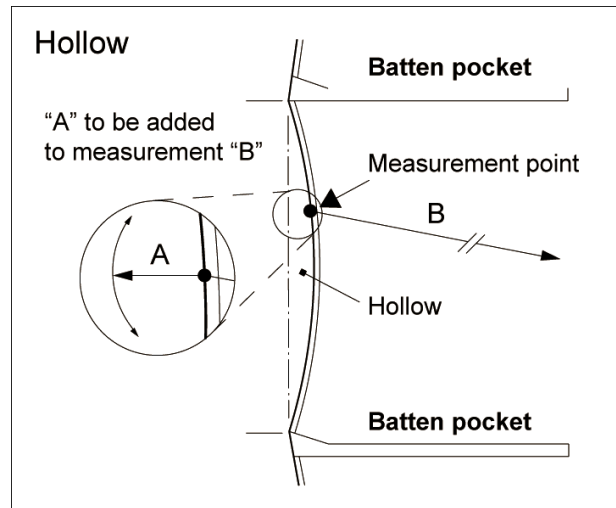
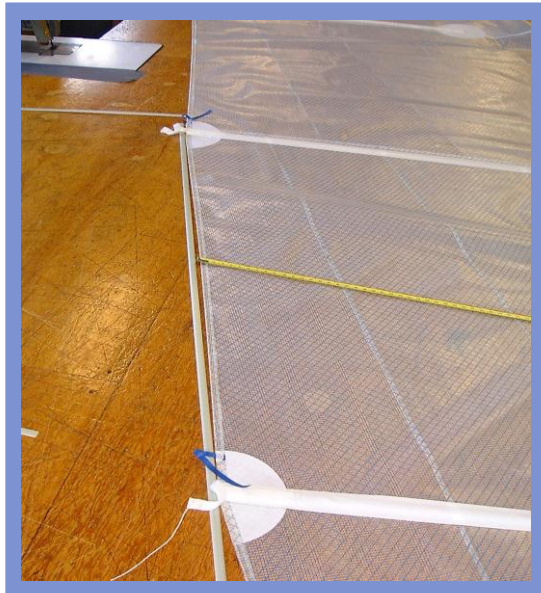

Figure K.2.3.9 *Bridging leech hollows.*

The spinnaker widths shall be measured as the straight line distance between the leech points as defined, for example the spinnaker half width in Figure K.2.3.10 is to be taken between the half luff point and the half leech point.



Figure K.2.3.10 *Spinnaker half width.*

K.2.4 Other Sail Dimensions (ERS G.8)

Other items to be measured include reinforcements, batten pockets, foot irregularity, seams and attachments.

Corner reinforcement size, whether primary or secondary, is measured from the corner measurement point, which may be outside the sail. The measurement is the greatest dimension from the corner measurement point to the outer edge of the reinforcement, and should be found by swinging an arc with the tape as illustrated in Figure K.2.4.1. Permitted tabling is not included in the measurement of reinforcement.

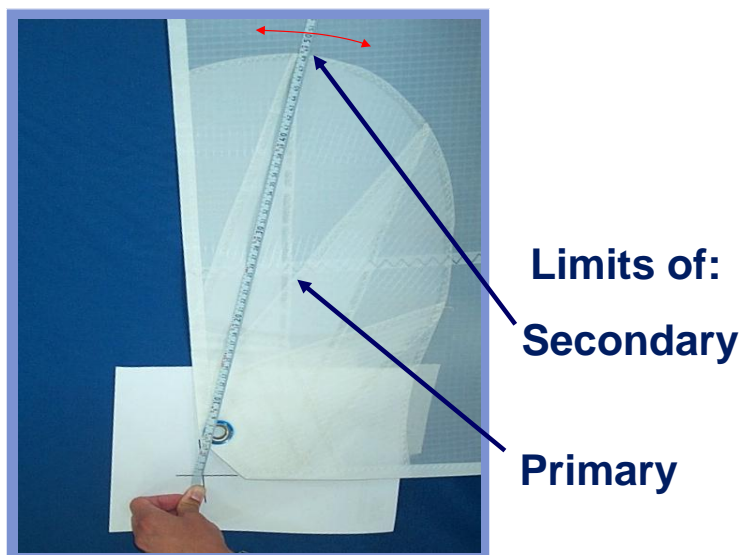

Figure K.2.4.1 *Corner reinforcement size.*

The measurement of any reinforcement, other than at one of the corners of the sail shall be taken to be the greatest dimension between any two points of the same reinforcement (Figure K.2.4.2 chafing patches, Figure K.2.4.3 batten pocket patches). This may not necessarily be continuous across the reinforcement.

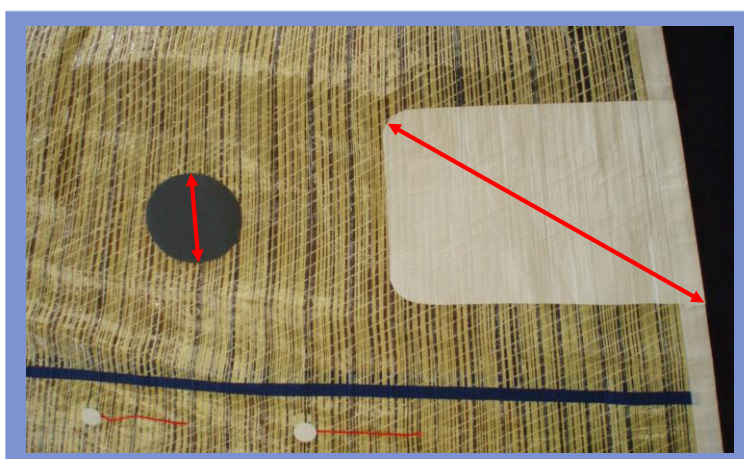

Figure K.2.4.2 *Chafing patch size.*



Figure K.2.4.3 *Batten pocket patch size.*

The inside and outside lengths of a batten pocket are measured ignoring the effect of any elastic or other batten retaining device.

The inside length is the greatest dimension measured parallel to the centreline of the pocket from the sail edge to the inside of the stitching, fold or similar at the inside end of the pocket. The outside length is the greatest dimension measured parallel to the centreline of the pocket, from the sail edge to the extreme end of the pocket material.

Local widening for batten insertion is not included in the measurement of either inside or outside batten pocket width.

The inside width is measured at 90° to the centreline of the pocket, between the inside of the stitching or similar on each side of the pocket. The outside width is measured at 90° to the centreline of the pocket, between the outside edges of the pocket material.

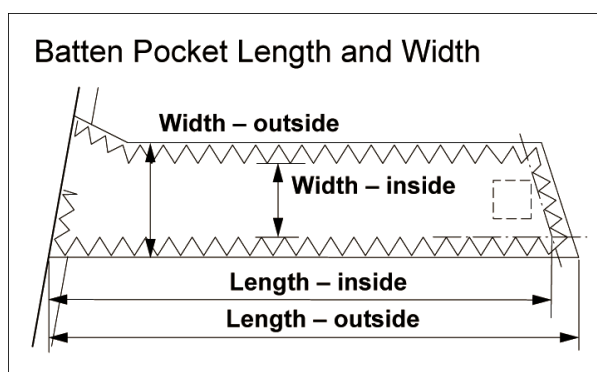

Figure K.2.4.4 *Batten pocket length and width measurement.*

To check the foot irregularity, with the sail flat in the area of the foot, the tack point should be folded over and run down the edge of the foot, and its extensions if necessary, until it reaches the clew point. During this procedure, the greatest dimensional difference between the two parts of the sail edge, measured at 90° to the edges, should be noted. The same procedure should be undertaken, folding over and running the clew point down the edge of the foot until it reaches the tack point. Again, the greatest dimensional difference between the sail edges should be noted. The foot irregularity is the greater of the two noted dimensions (figure 2.4.5).

Foot irregularity used together with a foot median limitation can help control the shape and size of the foot roach in cases where a deck sweeper headsail design is used by a class: appropriate foot irregularity values can prevent drastic changes in curvature along the foot, and the foot median controls total size of the roach.

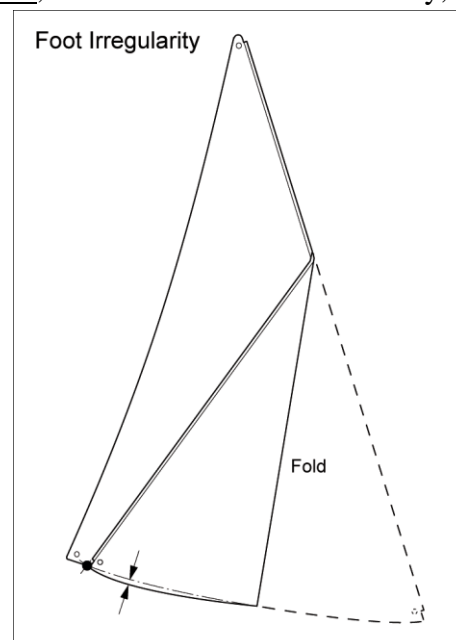

Figure K.2.4.5 *Foot irregularity.*

Attachment dimensions are measured depending on the position of the attachment itself: for example, for attachments at the head, length and width are measured as in figure F.2.4.6.

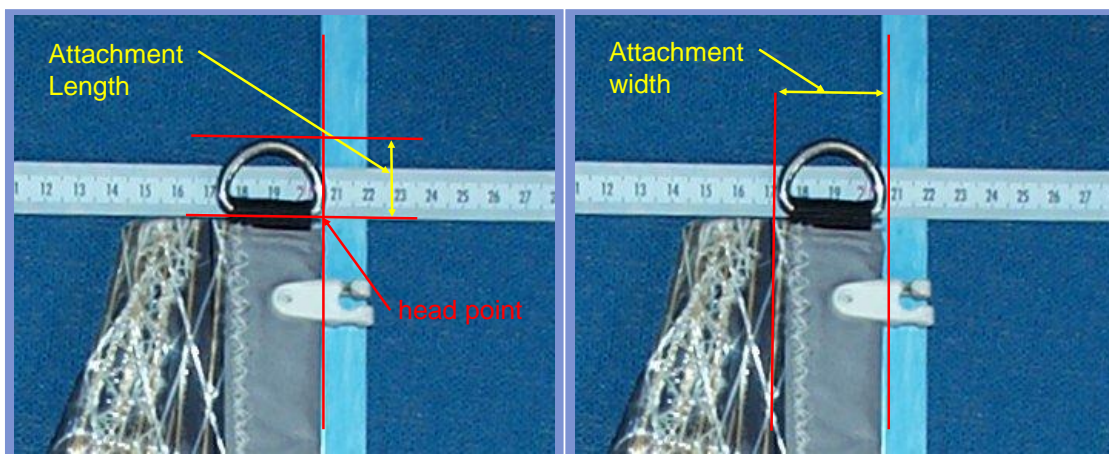

Figure K.2.4.6 Attachment at head: length and width measurement.

K.2.5 Additional Sail Controls

Additional sail controls include items such as the colour of the sail (Figure K.2.5.1), additional symbols like a women's rhombus (Figure K.2.5.2), the sail construction (e.g. number of panels) and the presence of valid class royalty tags (stickers, buttons etc., Figure K.2.5.3).

Where the class rules lay down a requirement for sail buttons or labels no sail shall be accepted by a measurer unless the button or label is securely attached to the sail. Buttons and labels are not supposed to be transferred from one sail to another and therefore the measurer, when satisfied that the sail complies with all the relevant rules, should sign or stamp across the button or label and onto the sail. Usually these items are numbered so it is a good idea to write down the number in the certification mark, provided it has space for notes.



Figure K.2.5.1



Figure K.2.5.2



Figure K.2.5.3

K.2.6 Identification on Sails

Measurement requirements for the size, shape and position etc. of class insignia, national letters and sail numbers are laid down in RRS 77& RRS Appendix G, and in most individual class rules. These shall be checked when required to be so by class rules or an MNA. A number of classes specify that sail numbers shall be sequential and not re issued and in such cases the legality of such sail numbers should be checked.

Where there are differences between the RRS and class rules, the class rules shall prevail. Where class rules invoke the RRS then, except when altered by class rules, the RRS shall be applied.

RRS Appendix G – 1.1 specifies that:

“Every boat of an ISAF International Class or Recognized Class shall carry on her mainsail and, as provided in rules G1.3 (d) and G1.3 (e) for letters and numbers only, on her spinnaker and headsail:

- (a) the insignia denoting her class;
- (b) at all international events, except when the boats are provided to all competitors, national letters denoting her national authority from the table below. For the purposes of this rule, international events are ISAF events, world and continental championships, and events described as international events in their notices of race and sailing instructions; and
- (c) a sail number of no more than four digits allotted by her national authority or, when so required by the class rules, by the international class association. The four-digit limitation does not apply to classes whose ISAF membership or recognition took effect before 1 April 1997. Alternatively, if permitted in the class rules, an owner may be allotted a personal sail number by the relevant issuing authority, which may be used on all his boats in that class.

Sails measured before 31 March 1999 shall comply with rule G1.1 or with the rules applicable at the time of measurement.”

RRS Appendix G - 1.2(a) requires, amongst other things, the national letters and sail numbers to be "clearly legible". Determination of this requirement will be relative and is not strictly a matter of measurement but at least it should be taken to mean legible to the RC and Jury under adverse situations. It also specifies that acceptable typefaces are those giving the same or better legibility than Helvetica (Figure K.2.6.1)

Several classes specify the colour of insignia, letters and numbers. Where this is not the case, the RRS Appendix G - 1.2(a) rule should be applied. This requires the national letters and sail numbers (but not the insignia) to be of the same colour.



Figure K.2.6.1 *Identification on Sails:*
Example of Helvetica typeface.

RRS Appendix G – 1.3 specifies the positioning of identification as follows:

- (a) Except as provided in rules G1.3 (d) and G1.3 (e), class insignia, national letters and sail numbers shall when possible be wholly above an arc whose centre is the head point and whose radius is 60% of the leech length. They shall be placed at different heights on the two sides of the sail, those on the starboard side being uppermost.
- (b) The class insignia shall be placed above the national letters. If the class insignia is of such a design that two of them coincide when placed back to back on both sides of the sail, they may be so placed.
- (c) National letters shall be placed above the sail number.
- (d) The national letters and sail number shall be displayed on the front side of a spinnaker but may be placed on both sides. They shall be displayed wholly below an arc whose centre is the head point and whose radius is 40% of the foot median and, when possible, wholly above an arc whose radius is 60% of the foot median.
- (e) The national letters and sail number shall be displayed on both sides of a headsail whose clew can extend behind the mast 30% or more of the mainsail foot length. They shall be displayed wholly below an arc whose centre is the head point and whose radius is half the luff length and, if possible, wholly above an arc whose radius is 75% of the luff length.

K.2.7 Advertising on Sails

The size and position of permitted advertising on sails is governed by ISAF Regulation 20, except at events at which the International Olympic Charter applies, either directly (e.g. Olympic Games) or indirectly by reference to it made in the charter of the relevant organization (e.g. Regional Games as provided for in ISAF Regulation 25).

Class rules and the rules of a Rating System may prohibit or limit the right to display Advertising on the boat. If the class rules or the rules of a System do not prohibit or limit

the right to display Advertising, it shall be permitted. This does not apply for Olympic Classes, which cannot prohibit or limit in any way the right to display advertising while racing.

Personal Advertising on sails shall be clearly separated from national letters and sail numbers and from Class insignia unless it is part thereof.

Event advertising on sails is permitted only on windsurfers, on each side of the sail, placed between the sail numbers and the boom (wishbone) and aft of the foot median line. Such advertising shall not exceed 0.4 m².

Sailmaker's marks are permitted at all times as follows:

- i) Boats: One sailmaker's mark, which may include the name or mark of the sailcloth manufacturer and the pattern or model of the sail, may be displayed on both sides of any sail and shall fit within a 150mm x 150mm square. On sails, other than spinnakers, no part of such mark shall be placed farther from the tack point than the greater of 300mm or 15% of the length of the foot.
- ii) Sailboards: One sailmaker's mark, which may include the name or mark of the sailcloth manufacturer and the pattern or model of the sail, may be displayed on both sides of the sail and shall fit within a 150mm x 150mm square. No part of such mark shall be placed farther from the tack point than 20% of the foot length of the sail, including the mast sleeve. The mark may alternatively be displayed on the lower half of the part of the sail above the wishbone (boom) but no part of it shall be farther than 500mm from the clew point.

K.2.8 Certification marks on Sails

When satisfied that a sail complies with all applicable rules, the official measurer can certify it by the attaching a certification mark. This is undertaken in different ways in different countries: certification marks usually take the form of a numbered sail button with the MNA logo (figure K.2.8.1), a sticker/label (figure K.2.8.2) or a stamp (figure K.2.8.3) with the details of the MNA and official measurer. In some cases the certification mark may be just a signature but classes should try to avoid this for their sails, as it is next to impossible to verify the identity -and the authority- of the person who signed the sail.

Buttons are small and don't have the details of the measurer. The serial number is known to the issuing MNA but for inspection purposes it is not easy to see who the measurer of the sails was.

Stamps need good quality ink, and this is not always easy to get. In any case ink will inevitably fade out after some time rendering the certification mark difficult to check or even invisible.

Good quality stickers, made of self-adhesive sail cloth material similar to the one used for sail numbers or sailmaker marks are probably the best solution. In fact they are used for the new ISAF IHC stickers (Figure K.2.8.4). For extra security, they may be sewn onto the sail.

Certification marks should always include the date because this is the only way to check if a sail is eligible for grandfathering in case of a specific class rule that applies after a certain date.



Figure K.2.8.1 Sail button



Figure K.2.8.2 Sail certification stickers

Certification marks should be at the tack of jibs and mainsails leaving the clew area for event limitation marks / stamps.



Figure K.2.8.3 Sail Stamp



Figure K.2.8.4 ISAF IHC sticker

K.2.9 Non-standard sail measurement examples

Although all new and many of the older classes have adopted the ERS for sail measurement, some classes are still using alternative non-ERS sail measurement protocols; some examples are described in this section.

Mainsail measurement rules

Mainsail widths are almost universally measured according to the ERS definitions, except from cases like the Optimist, where the “half width” is rather a half girth from middle of luff to middle of leech. However, the methods of defining the leech points, from which the width measurements are made, fall into two categories. The ERS uses fractions of the leech length halving and quartering the sail edge, so the recommended method is to find these points by “folding”. A number of classes including the Finn and the RC 44 (figure K.2.9.1), specify the leech points by “radial” distances from the head point. The ERS do define an upper point (and respective width) which is at a fixed radial distance from the head point, so classes such as the FD and Soling remain ERS compliant by using this point to avoid folding, however the SCR Soling rules also have a width measurement at a fixed distance from the mainsail clew.

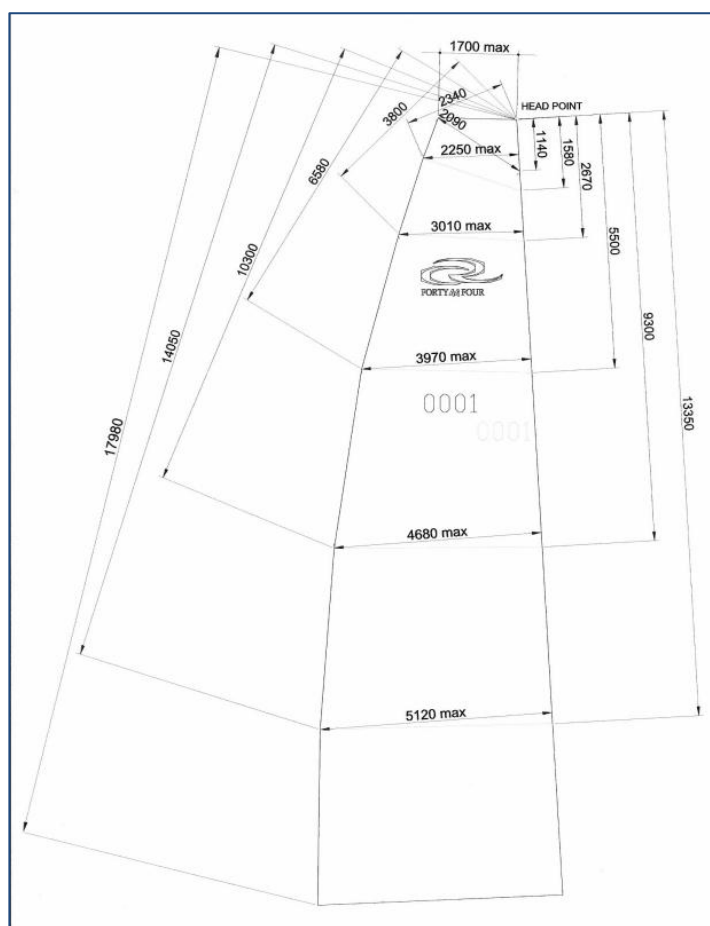

Figure K.2.9.1 RC 44 Mainsail plan.

A number of points should be kept in mind when comparing the folding and fixed radial methods of locating the leech points, especially for regatta inspection where time and training of volunteers are of the essence (see next section K.3):

- The mainsail head point is generally used as the starting point for mainsail inspection on tables. Arcs of the appropriate radius from the head point can then be quickly and accurately marked on the sail measurement table.
- For many classes the battens are either on or very close to the leech measurement points making it difficult to fold and accurately determine the measurement point, and impossible if the battens are not removed, such as for the Finn class which specifies sail measurement with the battens in the pockets.
- If the half leech point is in error, this error is then compounded when finding the three quarter and quarter points by successive folding. This can become an issue at the three quarter point where small errors can produce similar errors in the width measurement. Direct radial measurement is potentially more precise.
- Folding does take more time than direct radial measurement, especially if the three quarter and quarter points are required, but the sail then has to be unfolded and smoothed for the width measurement.
- For modern sails made of laminated sailcloth folding can damage the cloth unless significant care is taken.
- Folding very large and heavy sails (especially for offshore yachts) is not easy; however this is the method for rating systems like the ORCi or the IRC.
- The primary advantage of the fixed radial leech points is that the design of the head of the sail is independent of the leech length and thus this method of measurement produces a more one design sail. If a mainsail is specified by widths from the

fractional points as determined by folding, then as the leech is shortened the measurement points move up, as illustrated by the red outline in figure K.2.9.2, and the head of the sail becomes much larger. In contrast, if the leech points are specified by fixed radial measurements from the head point the sail design stays identical except for the reduction of the foot panel.

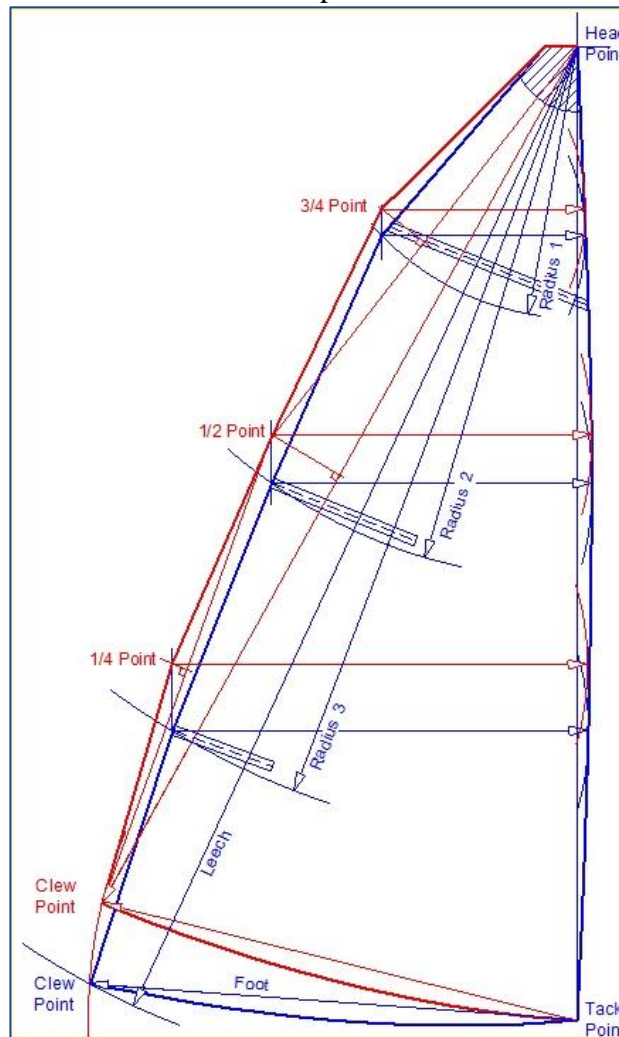

Figure K.2.9.2 A mainsail of maximum dimensions specified by fixed radial measurements to the fractional leech point, (blue), and a sail with reduced leech but identical widths now defined by folding (red).

The above having been said, many classes have successfully used folding to determine the leech measurement points, and there is no compelling reason for them to change.

Headsail measurement rules

Perhaps the simplest jib/Genoa measurement rules are those of the Flying Dutchman, which has none! For historical reasons the class specify the positions of the fairlead, tack and jib hoist height as shown in figure K.2.9.3, and allow any headsail which can be set within these points.

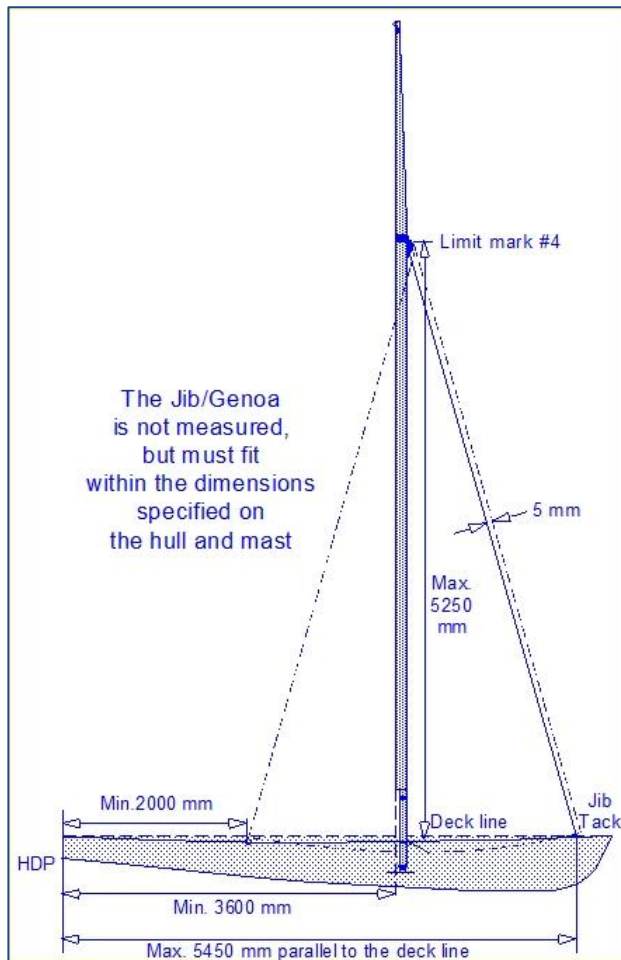

Figure K.2.9.3 The FD specifies hull and mast dimensions and leaves the jib/Genoa free

Figure K.2.9.4 outlines the differences between the ERS and Star Class headsail measurement as described in figure K.2.9.5:

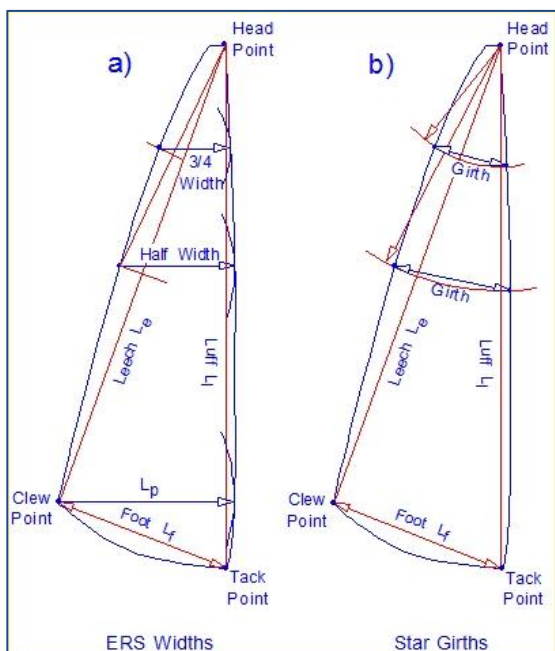

Figure K.2.9.4 ERS vs. Star measurement

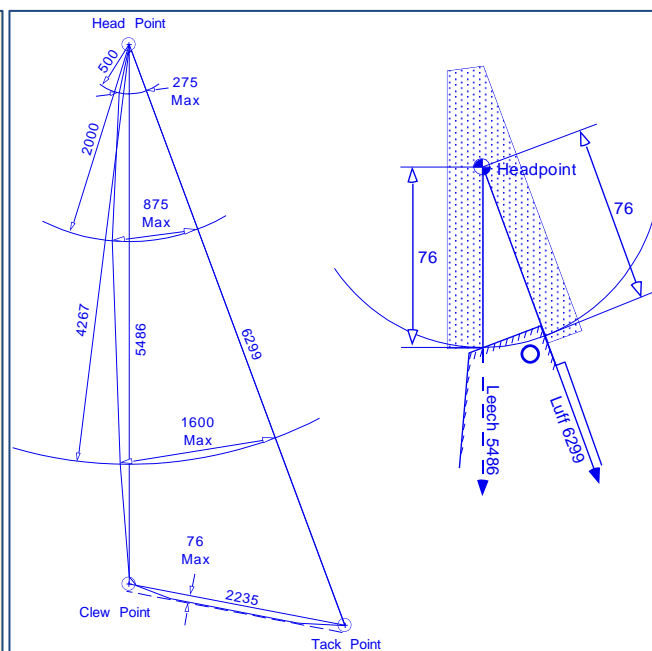

Figure K.2.9.5 The Star Jib rule

Although adoption of the ERS is under development, the current Star headsail rules specify a basic triangle as follows:

Maximum dimensions: *Luff* 6299
 Leech 5486
 Foot 2235
 Reinforcement radius 343
 Advertisement radius 337

Leech, roach, and draft shall be governed by measurements taken across the jib from points 500, 2000 and 4267 mm down leech and luff from the top of the measurement triangle. These cross measurements shall not exceed 275 mm, 875 mm and 1600 mm respectively. Leech and foot curve must not have concavities except that the leech may be hollow between battens. This hollow shall not exceed 15 mm. Headboards are not allowed. Clew boards shall be permitted only within a distance of 76 from the apex of the clew.

For measurement all the corners of the jib must simultaneously fall within a triangle of the above dimensions, and no portion of the sail shall fall outside of the triangle for at least 76mm from any corner of the triangle. Foot roach shall not fall outside the measurement triangle more than 76mm at any point. The centre of the grommet or thimble to which the halyard attaches shall not be farther than 38mm from the luff of the jib.

The head of the sail is positioned as shown in figure K.2.9.5 and the tack and clew must then fall within the specified triangle. However, at distances greater than 76 mm from the corner points sail edges may be outside the triangle and the width of the sail is controlled by the three “Star width” measurements, i.e. between points on the luff and leech at fixed radial distances from the head point, which is the apex of the triangle and not the ERS head point. The foot may extend outside the triangle but only by a maximum of 76 mm. This measurement system avoids the difficulties of precisely determining the corner points and makes regatta inspection very quick.

The Star Class controls the foot roach by limiting the extension of the foot below the line from the tack to the clew, but the 505 Class is taking another approach described below:

No part of the foot shall lie outside a measurement taken in the following way:

Lay out the headsail on a flat surface.

Fold the tack onto the clew and smooth the headsail to find the "intersection point" where the luff is intersected by the fold from the centre of the foot.

The measurement is the distance taken from the "intersection point" to the tack and the clew. No part of the foot shall lie at a greater radius from the "intersection point" with all wrinkles removed from the sail on the line of measurement.

It is a simple and effective control of both the roach and curvature of the jib foot, see figure K.2.9.6.

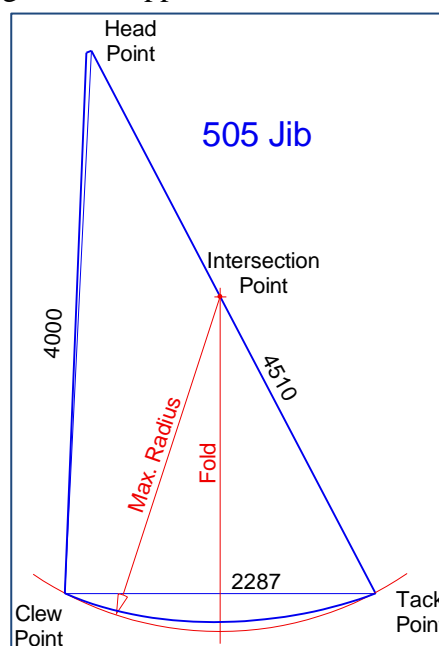

Figure K.2.9.6 *The 505 jib foot roach rule. The intersection point is equidistant from the tack and the clew, and the rule prevents sharp foot curvature changes near the tack and clew.*

K.3 Inspection of Sails

Event inspection of sails should be carried out under cover in good conditions of light, without wind or draughts and ideally, should be carried out on tables. These should be about 90 to 100cm high with a single flat working surface, although separate tables with their legs taped together will often suffice (Figures K.3.1 and K.3.2). Measuring on tables eliminates the need to bend down and to kneel and thus minimises the fatigue associated with sail measurement. If tables are not available then a gymnasium or dance floor is a good measuring surface.



Figure K.3.1 *Sail measurement table*



Figure K.3.2 *Sail measurement table*

Sail inspection should be undertaken using templates and measuring battens for small and medium size sails. Large sails should be measured with steel tapes, with the same techniques as used for normal certification measurement outlined in K.2. In most cases, large sails have to be inspected on the floor because of sheer size that prohibits the use of purpose built tables.

K.3.1 Sail Table Preparation

Some Classes have ready-made Mylar or similar area check templates. The use of a Mylar sail template has the advantages of portability, consistency of measurement from event to event; ease of training volunteers and of providing a clean surface which can quickly be setup in the event of emergency measurement. They can be laid flat on the measuring surface, taped or pinned down and checked against the class rules for accuracy. If ready-made templates are not available, they can be created directly on the measuring surface. In that case, inspectors must ensure that they are allowed to write and put tape on top of the sail table and that the surface is stable. The Flying Dutchman class has a trailer, for transporting templates and measuring equipment, which on arrival folds out to become a sail measuring table.

Tables should have a reasonably flat clean surface, preferably melamine coated. Their size depends on their use: If only one table is available, then it should be large enough to accommodate the largest sail of the inventory either laid flat on top or, in case of a spinnaker, to match the longest dimension of the sail.

To have the best possible arrangement of the various marks on the table, a set of sails should be placed on the table to find the optimum position and above all to ensure that all sails will fit inside the table when placed on the marks! The mainsail head and clew areas and all three headsail corner areas have to be marked on the table, giving the approximate positions of the sails when placed for inspection. For the spinnaker, all measurement

marks may be put in one line, near the edge of the table that is at least as long as the longest distance measurement specified in the class rules (usually that is the foot median). It is also important to check that it is possible to reach all parts of the sails when standing around the table edges: if not, assistants will be forced to get on top of the tables to reach a particular point and thus increase the time needed to inspect a sail.

Marks should be arranged in such a way that the sails will be laid down with the side for limitation stamping on top. For racing in trapezoid courses, limitation stamps are easier to see at the finish line if put on port tack clews.

If using one table for all sails (mainsail plus headsail -and spinnaker), colour-coded marks for each type of sail will help the assistants recognize and pick the correct marks for each sail.

If the number of entries and thus the total number of sails to be inspected is considerable, and the sails are measured in the standard ERS way with half, quarter etc. leech points, an “automated” sail table with a grid system (Figure K.3.1.1) can help because it saves folding time to find leech points. For events with fewer entries or with ample time such as an Olympic regatta, grids are not necessary. Grids are not needed when the sails are measured with leech points at fixed radial distances from the head point (ERS upper point style, e.g. Finn Class).

“Automated” Sail table example

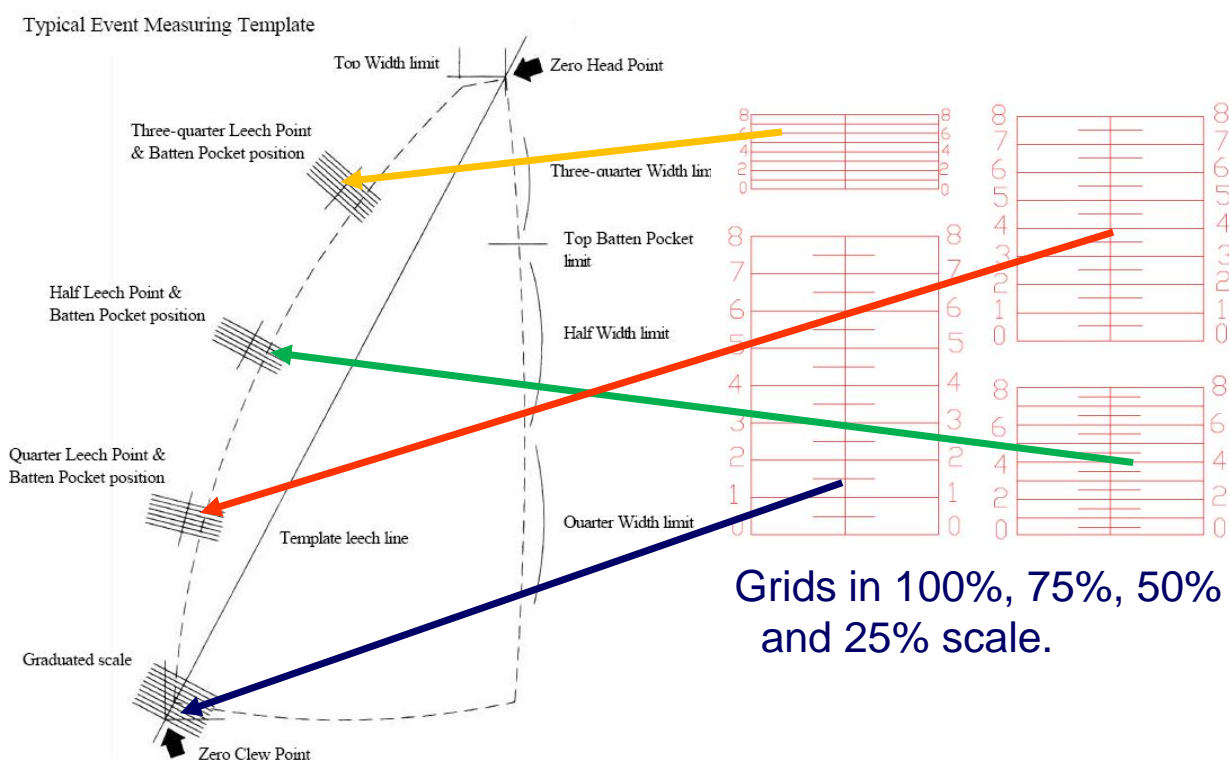

Figure K.3.1.1 “Automated” Sail table.

To set up a mainsail inspection table properly, it is important to start by laying a mainsail on the surface first, to decide on a position for the head point that keeps the clew point and the leech (when flaked) inside the table. The head point is the datum point for leech length measurement and also for the definition of the intermediate leech measurement points (half, quarter, three quarter and/or upper points) when the grid system is used instead of folding the sail as in certification measurement.

Once the head point and clew area have been decided as above, the head point is marked and a reference line is drawn from the head point to the clew, at least near the head, clew and around the mid-point of the maximum leech length distance (figure K.3.1.2). Points and lines should be made using thin pencil or marker pens, and the line is easier and more accurate to draw using a laser beam pointer and a batten.

In addition to the datum (head point), limit marks for the top width and a square to help set the mainsail properly have to be drawn. The best solution is to use a rotating template that a top width gauge, with the pivot at the head point, fixed on the table with a small screw (Figure K.3.1.3). While the fixed square drawn on the table must be made at the proper angle to keep the sail leech in line and flat when flaked, the rotating template will turn automatically to align the sail properly.

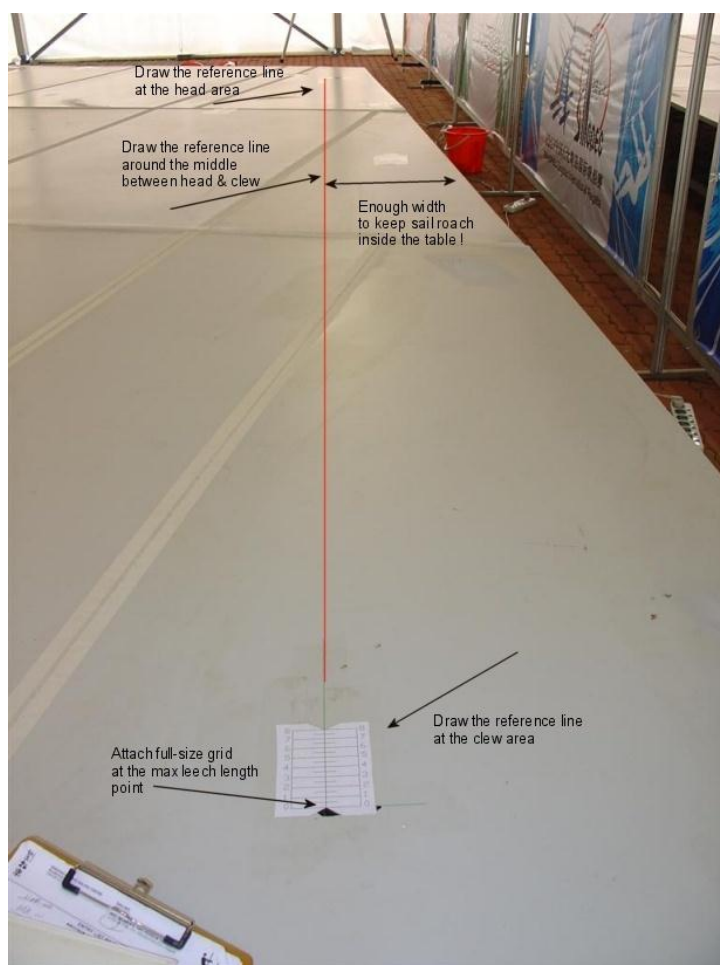

Figure K.3.1.2 *Leech length scale*

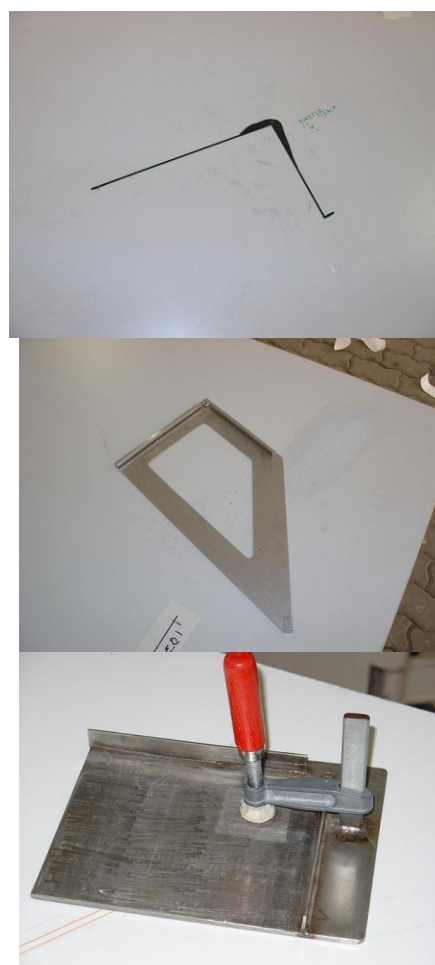

Figure K.3.1.3 *Head point jig*

For a non-grid table, only the maximum leech length point has to be marked on the reference line. In addition, if “upper point” style measurement points are defined in the class rules, short arcs with the defined radius should be drawn from the datum. When the sail is positioned on the table, these arcs will indicate the upper point positions on the leech.

If the grid system is to be used, then a set of grids have to be made, either drawn by hand directly on the table or printed on paper or transparency using a CAD program. In addition, a number of measurements have to be made on a number of sails, to find the amount of roach at each measurement point. That can be done centrally by the class so these numbers are given, or, as a last resort, a number of sails including those models found most often in the fleet, should be laid on the table to determine the variations of

the roach. These numbers will indicate the approximate position of the grids regarding the reference line for the half leech point, and then from the lines connecting the 50% scale grid to the head and clew points.

The 100% scale grid (Figure K.3.1.1) is positioned with its end at the maximum leech length point. Then, the exact middle point of the line between head and clew points is found, and then offset by the amount given as explained in the previous paragraph. This new offset “mid-point” is then joined with “new” reference lines from head and clew points as in Figure K.3.1.4: the offsets indicated there are valid only for a particular class and not standard numbers! The 50% grid is positioned at the offset mid-point, and the process is repeated for the two “new” reference lines, to find their middle points, which when offset, will give the positions of the quarter and three quarter (Figure K.3.1.5) grids.

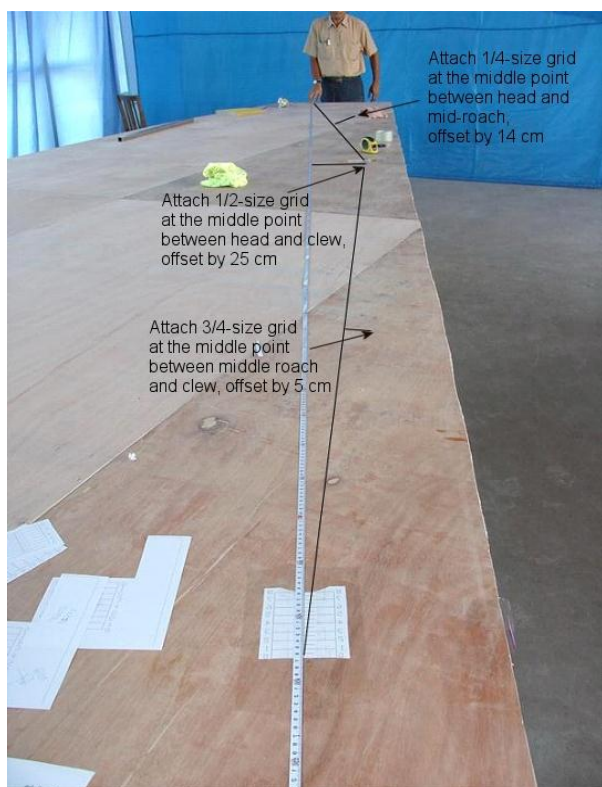

Figure K.3.1.4 *Leech point scales*

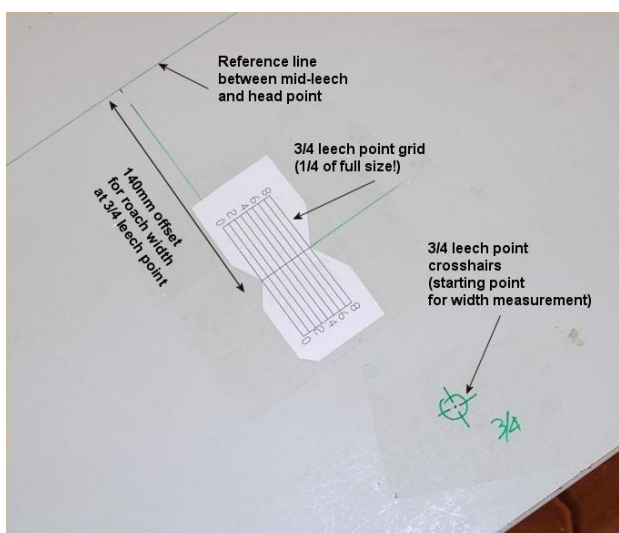

Figure K.3.1.5 *Three quarter point scale & width datum reference mark*

Having the half leech offset point as close to the actual sails leech, minimizes the (small) error that is introduced by the angle difference between the two “new” reference lines and the actual lines connecting the head, half leech and clew points on the sails. A small error is also introduced if the sail under inspection has a shorter leech than the maximum. In general, the error is small at the three quarter point, and given the scale of the grid, negligible. But in any case, when sails are found to be close to the limits, the position of the leech measurement point should be verified by folding.

The final step is to mark datum points for the sail widths, near the leech measurement points (Figure K.3.1.5), and their associated short arcs which define the width limits (Figure K.3.1.6). The other marks that may be needed are those for the batten pocket positions as in Figure K.3.1.6 for the inboard end of a full length top batten. All other items may be checked using measurement battens/rods or templates for numbers etc. It is

also helpful to attach a copy of the sail rules or a large sail plan diagram on a table corner for quick reference (Figure K.3.1.7).

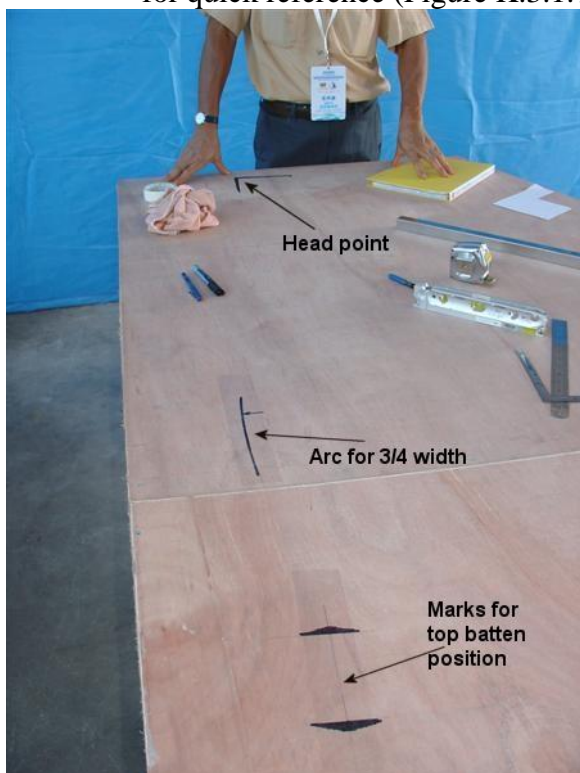

Figure K.3.1.6 Other measurement marks

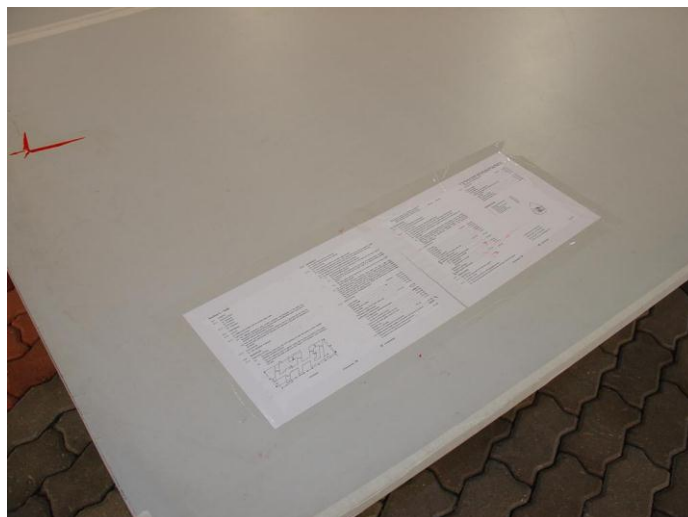

Figure K.3.1.7 Class Sail measurement rules

Headsails are easier to setup, as the head point is the datum for luff, leech and foot median lengths, so these should be marked with reference lines as in the case of the mainsail and maximum leech length. In addition, the foot length may be controlled with another reference line, and usually there is no need for a grid system: a jib foot may be folded easily to find the mid foot point.

Spinnakers may be checked using a grid system to find the leech measurement points, but everything may be done using a single reference line. The head point is again the datum and from that point a reference line is drawn down to the maximum foot median length. Then, the maximum leech length point is marked along with its half and $\frac{3}{4}$ points depending on class rules. The 100%, 50% and 25% scale grids are to be positioned at these points. Using the same datum point, the upper point, the limit for the foot median, and the various widths are marked on the line (Figure K.3.1.8). In this example, spinnaker marks are in red, headsail marks are blue and the mainsail marks (figure K.3.1.6) are black. All marks should be covered with transparent tape for protection.

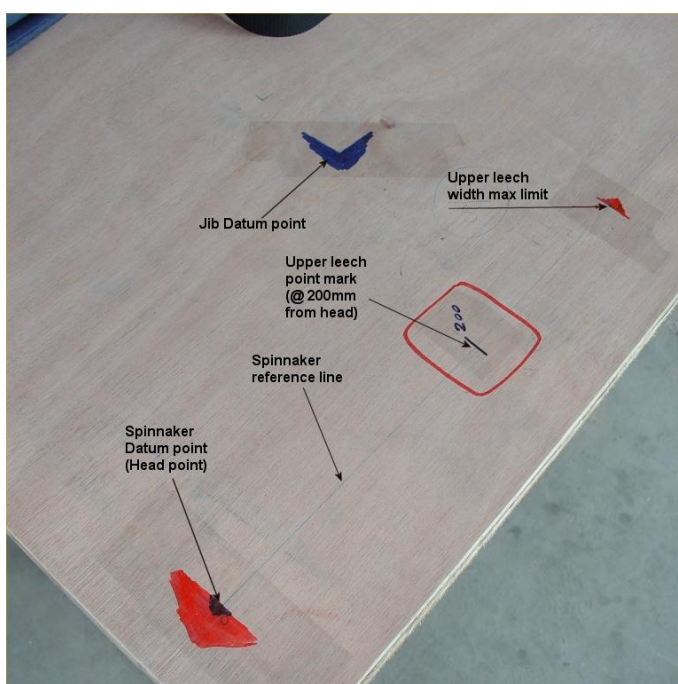

Figure K.3.1.8 Spinnaker measurement marks

K.3.2 Sail Table Application

Mainsails should be laid flat and flaked (Figure K.3.2.1) on the measuring template so that the head point is on the template's zero head point (Figure K.3.2.2) and the clew point is on the reference leech line in the area of the clew. Use the normal sail measurement batten to determine corner points if necessary. If there is a grid scale, the measurer should check the graduation upon which the clew point rests and mark the leech points on the sail at the corresponding leech graduations (marking the sail at the same numbers on all grids as the number the clew point rests on). Upper points should be marked on the sail directly from the table marks (Figure K.3.2.3).

Sail widths should be checked with the leech measurement point held at the respective datum point and the luff rotated (yellow arrow in Figure K.3.2.4). The limit which is indicated by the thin black line should be visible: if not, the sail should be checked with a tape measure.

Headsails are to be checked in the same way as above, but taking one measurement at a time. Spinnakers have to be laid on the table first with their leech and luff on the reference line, to mark all points, and then turned 90° to check widths on the same line. If the rules specify a foot median, the mid foot point may be found by folding.

Other measurements such as batten pockets, reinforcements, windows, sailmaker marks and sail numbers may be checked with measurement battens or special templates (Figure K.3.2.5).



Figure K.3.2.1 *Sail flaked on table*



Figure K.3.2.2 *Head positioned on jig*



Figure K.3.2.3 *Radial distance leech point mark*

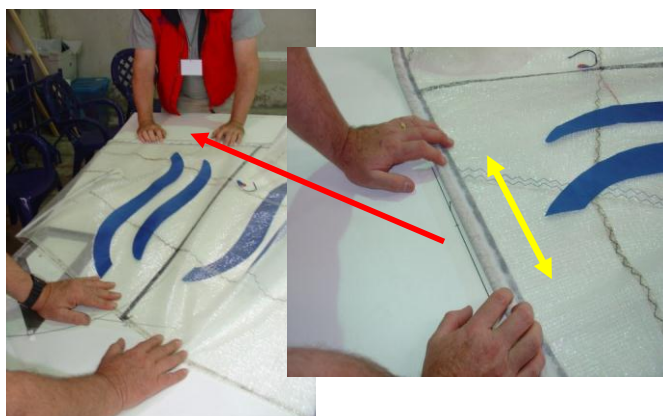

Figure K.3.2.4 *Sail width measurement*

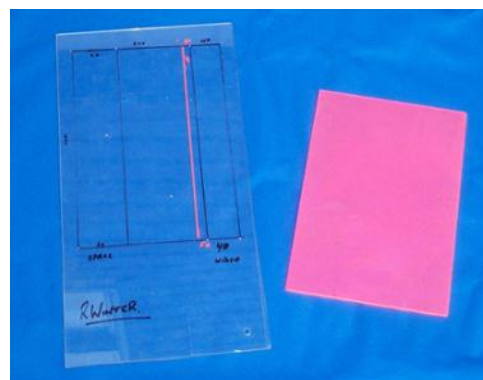

Figure K.3.2.5 *Sail number template*

K.4 Sail Area Measurement

K.4.1 General

There are only a few classes which require sail area to be found in a manner other than by a simple formula indicated in the class rules. These classes include the International Moth, A-Cat, C Class Catamaran, 10 square Metre division of multihulls and some other classes. For these classes the ISAF Sail Area Measurement Instructions apply.

K.4.2 Sail Area measurement instructions

The Sail Area Measurement Instructions have developed over a number of years with various editions being published from time to time. Accordingly, before proceeding to measure a sail the class rules should be examined to see which set of Measurement Instructions is to be used. If no indication is given, the current edition is the one to be applied.

The current Sail Area Measurement Instructions are quoted here below.

K.4.2.1 Preliminary remarks

The intention is to establish a reliable and simple method of measuring the whole driving area of the sail plan, including the spars, foils and flaps (for wing sails).

It is not possible to frame methods to deal with every eventuality and therefore in the case of unique or difficult shape of rig, the measurer may need to use his judgement in dividing the rig for measurement in order to calculate the area accurately. Combined rigs such as a soft trailing edge on a heavily shaped wing spar or a rig where the camber and shape is produced by tensioning when it is on the boat may be more conveniently and equitably measured in an “assembled for sailing” condition, rather than in component parts. In this case the measurer shall record the method used.

Elements of the sail plan which are vertical, or nearly so, when the boat is not heeled shall be measured. Elements of the sail plan which are horizontal or nearly so, when the boat is not heeled, such as fences and end plates, are not measured provided that:

- (a) The surfaces of such elements are not able to make an angle, measured at right angles to the fore and aft axis of the boat, greater than 10° to the horizontal when the boat is not heeled, and,
- (b) The total area of their surfaces does not exceed ten per cent of the measured sail area excluding such surfaces.

For the purpose of measurement of sail area the term “sail” shall be deemed to be that part of a soft sail outside the spars and includes the headboard, tabling and battens which extend beyond the edge of the sail. It shall not include cringles which are wholly outside the sail or bolt or foot rope which are inside the spars.

The area of any hole in the sail, the maximum dimension of which does not exceed 50 mm, shall not be deducted from the measured area.

K.4.2.2 Spars and Wing Sails

- (a) The guiding principle is the first sentence of K.4.2.1. Except as provided in d) below, the area of that part of any spar (including the luff spar of a headsail) or wing sail which projects above the sheerline, shall be measured.
- (b) Devices of fairings added to a spar or wing sail shall be measured as part of that spar or wing sail.
- (c) If the mast, spar, flap, or sail is of constant section throughout its length then the area shall be its length multiplied by the mean half girth.

If the mast, spar or sail is not of constant section, and its profile forms a fair curve or curves, it shall be divided into a suitable number of equal lengths and Simpson's Rule used to calculate the area, using the half girth measurements (see (e)) as offsets

$$\text{Simpson's Rule is: Area} = L (a + 4b + 2c + 4d + 2e \dots \dots \dots 2x + 4y + z) / 3$$

Where L is the uniform distance between offsets and a, b, c, d, e... x, y, and z are offsets.

Note: there has to be an odd number of offsets.

- (d) If the mast, spar or sail is not of constant section and its profile is not a fair curve, it shall be considered as a number of trapeziums and the half-girth measurements shall be found at the end of each. The sum of the areas of all the trapeziums is then the area of the mast, spar or sail.
- (e) The girth measurement shall be taken as the distance from the centreline round the surface of the spar or wing sail to the same point on the centreline. The resultant dimension shall be divided by two to give the half girth measurement.

An articulated wing-sail, such as that shown in Figure K.4.2.2.1, shall be measured as described above except that the skin girth shall be taken over all the sections when they are in the position which gives the greatest girth.

Note: the greatest girth may occur when the sail is at maximum camber, Figure K.4.2.2.2.

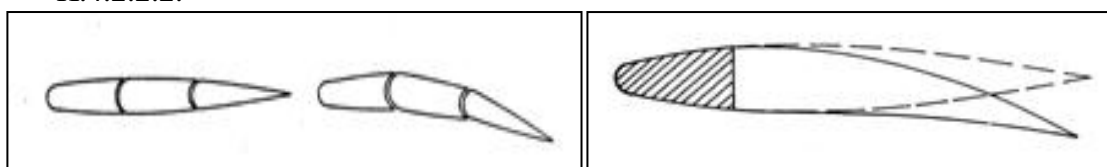

Figure K.4.2.2.1

Figure K.4.2.2.2

If, with the adjacent sections of an articulated sail in any position, the leading edge of one section is always recessed into the aft side of another, the sail shall be measured as in the above paragraph. For the purpose of this clause a fairing permanently attached to the sail shall be considered to be part of the sail.

A spar which supports the rig on which no sail is set directly, (e.g. a bipod straddling the hull, a structure fore and aft to support a main staysail or boom from which a loose footed sail is set) shall not be included in the measured sail area provided the maximum vertical or fore and aft dimension of the spar does not exceed one and a half times the maximum horizontal or transverse dimension.

The measured area of a boom shall be taken as its overall length multiplied by its mean depth in the vertical plane.

K.4.2.3 Soft sails set on Spars

When the sail is set on spars and between measurement bands the distance between the bands is used to obtain the primary dimensions of the main triangle.

Area Using Measurement Bands (limit marks)

- (a) With battens set in their pockets the sail shall be pegged out on a flat surface with just sufficient tension to remove waves or wrinkles from the edge rounds and to spread the sail, as far as possible, substantially flat. Once the sail has been pegged out in this way all the required measurements shall be taken and no alterations to the tensions shall be made.
- (b) Needles shall be fixed at the head and clew, making allowance for that part of the sail inside the spars so that the distance between the needles is the length of the leech. A third needle shall be fixed at a point so that it is the distance between the measurement bands on the mast from the head needle and also the distance of the boom measurement band from the mast from the clew needle. If the boom is shorter than the foot of the sail or if there is no boom the length of the foot shall be that

found by measurement with the sail set on the mast. A thin line shall be stretched round these needles to define the main triangle, Figure K.4.2.3.1

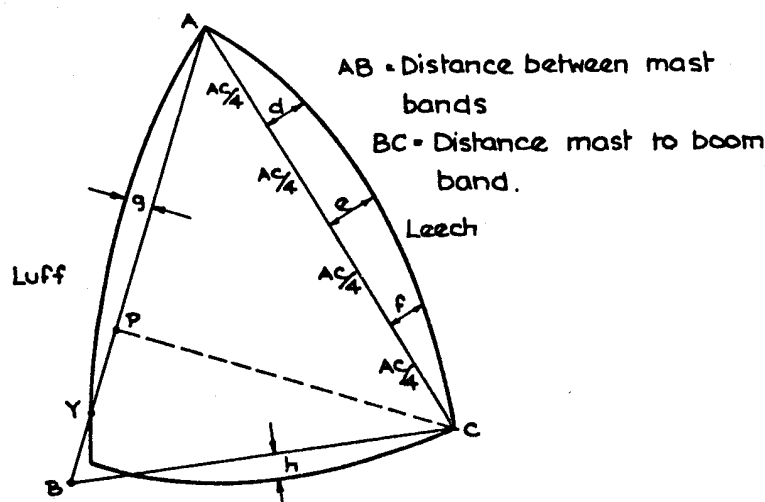

Figure K.4.2.3.1

The area of the main triangle shall be calculated from one of the following formulae or by a scale drawing.

(1) $\text{Area} = [(s \cdot (s-a) \cdot (s-b) \cdot (s-c)]^{0.5}$

Where $s = (a+b+c) / 2$

And $a = \text{length of luff}$

$b = \text{length of leech}$

$c = \text{length of foot}$

(2) $\text{Area} = (AB \cdot CP) / 2$ where CP is the minimum distance from C to the thread from A to B.

The area of the luff round shall be calculated and added to or subtracted from the area of the main triangle. If the curve is fair and continuous its area shall be taken as two thirds of the product of the chord length and the maximum perpendicular offset to the chord.

The area of the luff round in Figure K.4.2.3.1 is: $2 \cdot g \cdot (AY) / 3$.

The offset to the chord shall be taken as the maximum distance between the point on the sail corresponding with the aft edge of the mast, and the thread defining the main triangle.

The area of the leech round shall be found as follows:

(a) where the leech is a continuous fair curve from point A to point C in Figure K.4.2.3.1 the area is taken as: $AC \cdot (1.16 \cdot d + e + 1.16 \cdot f) / 4$.

Where: AC is the leech length indicated in Figure K.4.2.3.1; d, e and f are the perpendicular offsets between the points on the thread from A to C 1/4, 1/2 and 3/4 of the distance between the leech measurement points A and C and the edge of the sail. For the purposes of the measurement of the offsets, any hollows in the leech shall be bridged.

(b) where the leech is not a fair curve front point A to point C in Figure K.4.2.3.1 the area of the leech round shall be found by dividing the area into trapeziums, triangles and segments and measuring each. For the purpose of this instruction the

area of a segment shall be taken as two thirds of the product of the chord of the round and the maximum perpendicular offset to the chord.

The area of the foot round, if the sail can be pegged out substantially flat, shall be measured in the same manner as the luff round.

Where the foot has a “shelf” or a substantial amount of shape so that when the foot is extended there is loose or bulging material above it; then the area of the “flow” of the bulging material shall be determined as follows (see also Figure K.4.2.3.2 below):

A measurement shall be taken from the straight line joining the tack to the clew, in the way of the greatest fullness, to an arbitrary point where the sail does lie flat.

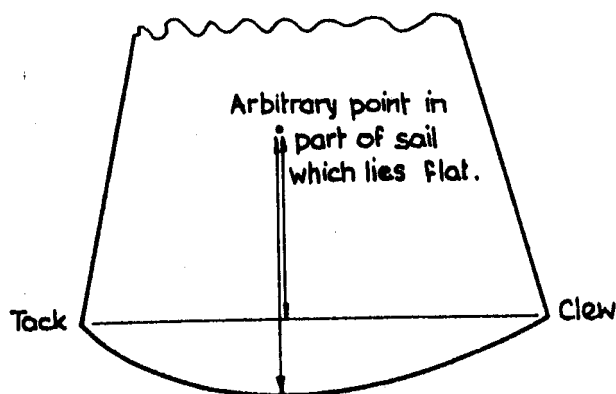

Figure K.4.2.3.2

A second measurement is then taken from the arbitrary point of greatest fullness following the folds or bulges or material.

The difference between the two measurements represents the offset of the rounded foot. The area of the foot round is taken as two thirds of the length between the tack and clew multiplied by the offset.

The area of the shape BYTX in Figure K.4.2.3.1 is not deducted from the area of the main triangle.

Area where there are no Measurement Bands (limit marks) on Spars

- (a) With the battens set in their pockets the sail shall be pegged out on a flat surface with just sufficient tension to remove waves or wrinkles from the edges and to spread the sail, as far as possible, substantially flat.
- (b) Needles shall be fixed at the head, tack and clew. A thin fine or thread shall be stretched tight between head, tack and clew to define the main triangle.
- (c) The area of the main triangle shall be calculated in the manner indicated in the previous section.
- (d) The area of the luff, leech and foot rounds shall be found in accordance with the instructions above.

K.4.2.4 Soft sails not set on Spars

- (a) A soft sail which is not set on a spar, such as a headsail, set on a stay or flying, shall be measured in accordance with the instructions above, except that if the leech

has an offset not exceeding 5 per cent of the leech length and is a fair curve, the area of the leech round shall be measured in accordance with K.4.2.3

- (b) If the luff of the sail is wired, sufficient tension shall be applied to remove bends or kinks in the wire.

K.4.2.5 Sails of unusual shape

The foregoing instructions assume that the sails are essentially triangular.

If a quadrilateral or multilateral sail is to be measured, the sail is to be divided into suitable triangles whose area can be measured and added. The areas of the luff, foot and leech rounds shall also be added, or subtracted as the case may be. The measurer shall record the method he has used to assess the area of the sail.

K.4.2.6 Spinnakers

The area of the spinnaker shall be taken as:

$$(SF \cdot SL) / 2 + 2 \cdot (SMG - SF / 2) \cdot SL / 3$$

where:

SF Width of foot; measured round the edge of the sail between the lowest point on the leeches.

SL Leech length, measured round the edge of the sail from the highest point on the sail at the head to the lowest point of the sail on the leech. If the two are not equal, SL shall be the mean of the two leech lengths.

SMG Width at half height; shall be taken as twice the distance between the mid-point of the leeches and the nearest point on the centrefold. The mid-point of the leech shall be determined by measuring round the edge of the sail half the length of the leech from the head.

K.4.3 Recording Measurements and Calculations

Because of the various ways in which a sail can be divided up for measurement, the measurer is required to state clearly the method he has used and show his calculations to support the answer he has obtained.

K.4.4 Test Case: Moth Sail Measurement

ISAF Rules for Sail Calculation

This method is valid for sails measured until 31.12.2004. After that date only the triangulation method may be used.

If a sail does not have a triangular shape including a smooth curve for the leech, the triangulation has to be used also because the formula for the leech does not cover unusual leech curves.

The twine should be stretched around these points (A, B and

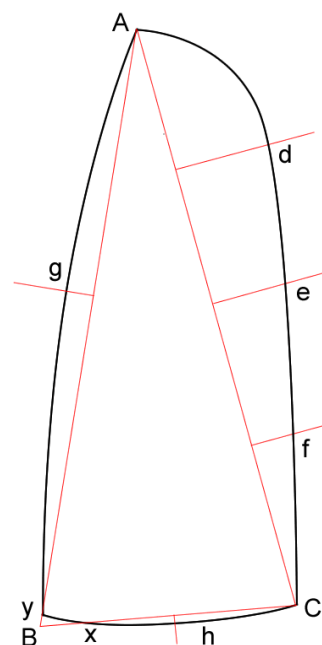

C) and tensioned until they revert to the same position once 'twanged'. Foot, luff and leech rounds should then be secured by bulldog clips fastened to short skewers, to prevent any transfer of areas.

Here follows an example using hypothetical measurements, of how to measure the sail using the ISAF-Rule method:

- AB has been measured from the spar as 5.185m twine set to this dimension.
- BC (say 2.000 m) is determined by measuring the foot length from Point C to the tack of the sail.
- Look along the luff to where the twine intersects the inside of the bolt rope or luff on a pocket luff sail at point (X).
- Take measurement AX (say 4.900m).
- Measure the maximum perpendicular offset (g) to the inside of the bolt rope or luff on a pocket luff sail at this point, using a tee square and small tape (say g = 0.150m).
- Similarly find where the twine cuts the foot of the sail at Y and measure CY (say 1.900m). Measure the maximum perpendicular offset (h) along CY (all as described for the luff round) (say h = 0.080m). Where the foot has a shelf or a substantial amount of shape so that when the foot is extended there is loosed or bulging material above it, a measurement shall be taken from the straight line joining the tack to the clew, in the way of the greatest fullness, to an arbitrary point where the sail does lie flat. A second measurement is then taken from the arbitrary point of greatest fullness following the folds or bulges or material. The difference between the two measurements represents the offset of the rounded foot.
- Next measure AC (say 5.200m).
- Divide this by four to give you the measuring intervals (e.g. $5.200 / 4 = 1.300\text{m}$), measuring stations are therefore at 1.300m, 2.600m and 3.900m from either A or C.
- Mark with a cross on the sail where each one of these stations occurs (on the line of the stretched twine) and using the twine as a base line project perpendicular offsets to the leech at each station and mark where this crosses the leech.
- Measure each offset with a square in turn d, e, f. (say 0.600, 0.500, 0.400). Your measuring should now be complete assuming the sail does not exceed 8.00m^2 , but you are advised to leave it pegged out until the area has been verified.
- The main triangle ABC is calculated using the half circumference $S = (AB+BC+AC) / 2$ with the formula: $\text{Area} = \sqrt{[S (S-AB) (S-BC) (S-AC)]}$
[in the example: $S = 6.193 \text{ m}$ and $\text{Area} = 5.095 \text{ m}^2$]
- The foot area is calculated by: $\text{Area} = 2/3 \text{ BC} * \text{h}$ [in the example 0.101 m^2]
- The luff area is calculated similar: $\text{Area} = 2/3 \text{ AY} * \text{g}$ [in the example 0.490 m^2]
- The leech area is calculated by: $\text{Area} = \text{AC}/4 * (1.16\text{d} + \text{e} + 1.16\text{f})$ [in the example 2.158 m^2]
- The total area is summarized by main triangle, foot area, leech area and luff area [in the example 7.84 m^2]
- All calculations have to be carried out to the 3rd decimal, which is rounded between 4 and 5
- The final result will be rounded down to 2 decimals.

Triangulation Method

Any sail measured after 31.12.2004 has to be measured using the triangulation. Also sails with unusual shapes, which are measured before 1.1.2005, have to be measured by triangulation.

For the triangulation the sail has to be divided into a number of suitable triangles. Any arrangement of the triangles on the flattened sail is possible. For a common moth sail the subdivision according to the diagram is recommended, because a computer spreadsheet is available to calculate the area of the triangles.

Here follows an example using hypothetical measurements, of how to measure the sail using the addition of triangle areas method:

- Determine head point “A”, tack point “B” and clew point “C” as described above. (The tack point “B” is **not** identical with the Point “B” used in the ISAF method. It is the real tack point as described in the diagram above.)
- Mark the sail with crosses at both ends of the intersection centreline batten / sail. At the luff use either the inner side of the luff rope or prolong the centreline of the batten to the forward edge of the sail, if it is around the mast.
- The area between the battens (BC is treated as batten) is divided into two triangles by a diagonal, which always starts at luff segment top and ends at leech segment bottom.
- Each quadrilateral consists of the bottom “c”, the 2 sides (luff “c” and leech “d”) and the diagonal “b”. The top is used as bottom for the upper quadrilateral.
- The top of the sail has only 3 lines, because the leech segment is the diagonal [b].
- Measure all distances “a” along the luff curve, all diagonals “b”, all battens “c” and all leeches segments “d”. At the top of the sail the leech segment “d” is omitted, because the diagonal represents that part of the leech.
- Measure the foot offset “h” as biggest perpendicular offset of the foot curve from the line BC if applicable.
- Put all values into the spreadsheet and choose the additional calculation options for luff round or foot round sails.
- For the manual calculation the formula for the main triangle (ISAF-rule) can be used, using the distances a, b and **lower** c for the first triangle and the distances b, **upper** c and d for the second triangle.
- Example using the rows 10 and 9 for the lowest quadrilateral:
 $S = 1/2 * (a_{10} + b_{10} + c_{10})$ and $A1(10) = \text{Square root} [S * (S - a_{10}) * (S - b_{10}) * (S - c_{10})]$ for the first triangle and
 $S = 1/2 * (b_{10} + c_9 + d_{10})$ and $A2(10) = \text{Square root} [S * (S - b_{10}) * (S - c_9) * (S - d_{10})]$
- The foot area is calculated in the same manner as in the ISAF rule: $\text{Area} = 2/3 BC * h$

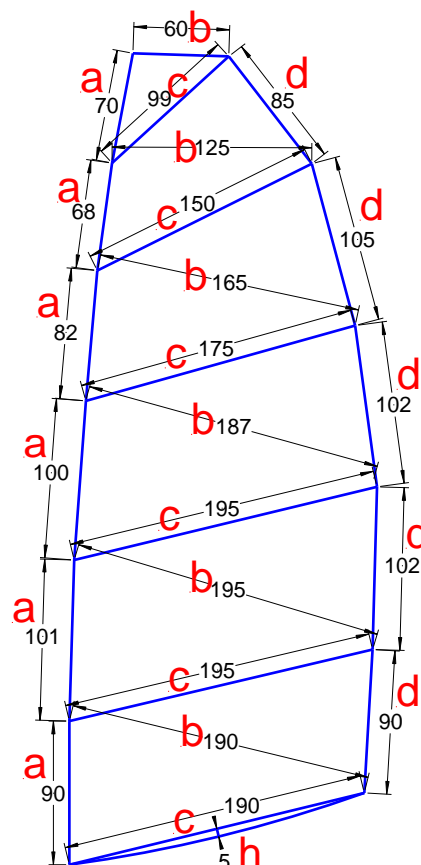

- If the sail encloses the mast, a value of 0.05 * the sum of all segments “a” has to be subtracted.
- If the sail encloses the boom, a value of 0.09 * the lowest segment “c” has to be subtracted.
- The sum of all triangles and the foot area (subtracted by the luff pocket and the boom pocket if applicable) is the sail area, rounded mathematically to 2 digits.

Numerical example using the spreadsheet:

Triangulation	Area:	7.68	m ²		Version	4				
Luff round ->	x	0.256	Measurements in meters!							
Foot round ->		0.000	h	0.050	Foot area 0.063					
		Luff	Diagonal	Batten	Leech					
	No.	a	b	c	d	S1	A1	S2	A2	
Top	1					0.000	0.000			
	2					0.000	0.000	0.000	0.000	
	3					0.000	0.000	0.000	0.000	
	4					0.000	0.000	0.000	0.000	
	5	0.700	0.600	0.990		1.145	0.207	0.000	0.000	
	6	0.680	1.250	1.500	0.850	1.715	0.421	1.545	0.419	
	7	0.820	1.650	1.750	1.050	2.110	0.671	2.100	0.772	
	8	1.000	1.870	1.950	1.020	2.410	0.919	2.320	0.880	
	9	1.010	1.950	1.950	1.020	2.455	0.951	2.460	0.960	
Bottom	10	0.900	1.900	1.900	0.900	2.350	0.831	2.375	0.841	
	Luff ->	5.110	Foot							

When measuring a sail using either the ISAF-Rule or the addition of triangle areas, the IMCA sail area calculation Excel spreadsheet will assist.

With the exception of the area reduction allowed by the rules for sails that enclose the mast or boom, small areas where there is no sail material present near the tack, head or clew should not be subtracted from the total sail area. An example of this would be where the luff pocket ends before the tack point.

When the sail area has been calculated as complying then the sail should be signed and dated in indelible ink near the tack.

If a sail calculates to 8.004m², please remember that this does not exceed 8.00m² when rounded to two places of decimals at the final total area. Always observe that 5 rounds up and 4 rounds down when applied to the trailing decimal number.

If a sail is oversized, once measured, it is the responsibility of the owner to determine how to make it measure within the 8.00m² line. This is most commonly done by trimming the foot of the sail.



INTERNATIONAL MEASURERS' MANUAL

SECTION L

Equipment Inspection

L	Equipment Inspection	
L.1	Introduction	L 2
L.2	Fundamental issues	L 2
L.2.1	Single Class versus Multi-Class events	L 2
L.2.2	Inspection Levels	L 3
L.2.3	Facilities and resources	L 4
L.3	General Guidelines	L 5
L.4	Equipment Inspector's Responsibilities	L 6
L.5	Measurement team Management	L 9
L.6	Inspection methods and tools	L 9
L.7	Special Inspection issues	L 10
L.7.1	Personal / Portable Equipment	L 10
L.7.2	Crew weight	L 11
L.7.2.1	Class Rules Approaches	L 12
L.7.2.2	Event Inspection of Crew Weight	L 14
L.7.3	Wet clothing	L 17
L.8	Equipment Inspection Procedure Examples	L 18
L.8.1	Measurement Preparation & Outline of Stations: OPTIMIST Class	L 18
L.8.2	Measurement Regulations: 470 Class	L 23
L.8.3	Laser Class Inspection Guidelines	L 26

L.1 Introduction

Equipment inspection is defined in the ERS as control carried out at an event as required by the notice of race and the sailing instructions. Also known as event inspection or regatta measurement, it is a formal procedure to check compliance with the class rules, ranging from checking certain items only, like the weight of boats or sail measurements, to almost complete measurement of all competing boats. In major events like World or Continental Championships and certainly at the Olympic Games, this task should be done by a team led and managed by one or more International Measurers.

It should be remembered that regatta inspection is undertaken to check that the boat is class-legal in at least some respects and does not guarantee that the boat is completely class legal. Usually a full measurement cannot be undertaken because of the various constraints in time and personnel; however, this in no way relieves the owner or competitor from their responsibility to sail a boat complying with all its class rules. There should be no confusion between regatta inspection and certification control: in the first case the measurer/inspector is appointed and obtains his authority from the Race Committee of the specific event, in the second case the measurer has a contract either with the builder or with the owner of the boat and obtains his authority from the MNA of the owner.

Being more of a check than a measurement, the actual measurement data usually do not need to be known or recorded, and procedures, such as the use of jigs or templates which reduce the measurement time required can be adopted.

L.2 Fundamental issues

A number of factors affect the preparation and planning of equipment inspection at an event. They may be summarized as follows:

- Number of Classes competing, and the size of the fleets
- Desired level of inspections
- Availability of facilities, personnel and resources

L.2.1 Single Class versus Multi-Class events

A single Class event is the most common scenario that an International Measurer will face in his career, and this usually refers to major events such as World or Continental Championships. In such cases, it is possible to concentrate all available resources to perform inspections on as many items as possible and in more depth. Ideally, an International Measurer of the particular Class should be appointed to lead the measurement team. A number of International classes require their chief measurer to be the regatta inspector for their World Championships. Lower level events also fall into this category, but the inspectors may be non-IMs.

Multi-Class events have different requirements in the resources and experience levels of the appointed inspector(s). In this case the available resources have to be allocated such as to fulfil the essential needs of each participating class and may require simplified inspections. Major National events and ISAF Grade 1 events are prime examples, and at least for the latter, an IM related to one or more of the participating Classes should be appointed to lead the measurement team.

For equipment inspection purposes, Olympic Games and Combined World Championships should be treated as a group of Single-Class events. These events also have a Chief Measurer appointed, but he is an overall manager, depending on Class IMs to lead the individual Class measurement teams. In those cases, the Measurement Committee is also independent of the Race Committee in matters such as class rule infringement reports and subsequent protests.

L.2.2 Inspection Levels

There can be no fixed rule about the required level of inspection at an event. Above all, this depends on both the level of the event –higher level events require more detailed inspections- and the nature of participating Class: measurement-controlled classes require different controls to those for manufacturer-controlled classes. In addition, one can choose to have pre-race or post-race inspections, or both. Certain items such as boat weight are better controlled before racing starts: it is impossible to accurately weigh a wet boat after racing on a cold day and spinnakers are notorious for stretching on heavy air days or if involved in a capsized. On the other hand, “use of equipment” rules and wet clothing rules can be checked after a race without trouble. It must be emphasized that non compliance during pre race inspection can be rectified with no penalty, but infringements found in any post race inspection, which is usually limited to a sample of only a few boats, will lead to disqualification. Thus post race inspection alone has been found to not be either fair or efficient, as it does not give the competitor the opportunity to correct unforeseen errors in their equipment.

Prior to racing, and in the case of a series this should be taken to mean the first race of the series, an inspector's prime responsibility is to achieve a state where all equipment complies with the rules. In line with this responsibility, if an inspector establishes non-compliance then he should require correction. It is only after an inspector has done this and the defect is not corrected that he should report the matter to the race committee. In other words, prior to racing the inspector should actively endeavour to achieve rule compliance, but be conciliatory, with the interests of the competitors in mind.

After racing has started, an inspector's prime responsibility is to judge compliance as required to do so by the race committee, through the Sailing Instructions, or by the protest committee as a result of a protest. When an inspector is given the authority through Sailing Instructions to undertake spot checks, care should be taken in the choice of the items to be checked. The choice of boats to be checked is often made by the race officer rather than the equipment inspector. It should be borne in mind that there are no alternative penalties for the infringement of an equipment rule. Non-compliance with even a minor, non-performance or non-safety related measurement rule is likely to lead to disqualification.

As a recommendation, there may be 5 levels of inspection as follows, and they may be adapted to suit local conditions, personnel, event specific requirements and the nature of each Class:

LEVEL 1 - (National qualification events)	Only Measurement Certificate and form + Safety equipment
LEVEL 2 - (National Championships)	Measurement Certificate and form + Corrector weights + Sails + Safety equipment
LEVEL 3 - (National Championship of Olympic Classes or International Events)	Measurement Certificate and form +Sails + Weight and Corrector Weights + Safety equipment + Marks on spars
LEVEL 4 - (International Qualifying Events, Continental & World Championships)	Measurement Certificate and form + Sails + Weight + Corrector Weights + Marks on Spars + selected items + Safety equipment
LEVEL 5 - (Olympic Regatta)	Measurement Certificate and form + Almost full Measurement + Safety equipment + Olympic requirements

In addition, at all levels there should be limitation marking of equipment whose replacement during the event is limited and controlled by class rules.

Level 4 inspections are more or less standardized for each Class, and if the appointed inspector is a Class IM, they are more likely to be performed in the same way from one event to the next.

L.2.3 Facilities and resources

The facilities required to undertake a programme of inspections at a championship will depend on the work which is to be carried out. It is very rare that all the facilities needed are available so the measurers will have to adapt their work or methods to take into account what is available.

Wherever possible all measurements should be performed in facilities with a solid floor, under cover and in any case out of the wind. Ideally there should be enough space to do all the controls in one place connected to the boat park and having separate entry and exit points that can be closed to keep wind out. In a hot climate venue, it may be necessary to have an air-conditioning system. Usually, this doesn't apply in cases of large boats, where the only chance for hull inspection may be before they are launched for the event, and the boat inspection can only happen at the launching crane area.

Hull measurement can be carried out in any building with suitable access, or in a large tent. Whatever is used it should have a fairly level floor, particularly if the boats are to be moved. Weighing machines, if of the platform scale type, require a firm foundation. If of the hanging type, they require some overhead structure able to take the loads with a high safety factor.

Sail measurement, ideally should be carried out on tables about 85-90 cm high. These tables have to be specially made to suit the particular class and consequently are not always available. In addition, for bigger boats it may be impractical or even impossible to make such tables. Therefore sometimes the sails may have to be measured on the floor. If so, the floor should preferably be of wood or some other smooth and dust free surface. The use of a Mylar template for sail inspection has the advantages that it can be quickly rolled out on tables or the floor, provides a clean surface, and consistent sail inspection from regatta to regatta. It is especially useful for mid regatta inspection when measurement facilities have often been disassembled. As a last resort, an empty parking space may be used instead, provided it is not used by cars during the inspection period.

If the inspection programme is to include hull measurement, centre of gravity or weight distribution tests, weighing, rudder and centreboard measurement, spar measurement and sail measurement, it is clearly impractical for all the work to be carried out by only one or two measurers. So, in those cases it is necessary to use non-qualified assistants. This is acceptable, provided the assistants are adequately instructed on how to undertake the measurement, what to expect to find, and to report any discrepancies to a qualified measurer to make any final decisions. Some operations also require the boat to be moved -for instance weighing- and it is very helpful if there are people available to assist with this work. It is essential however that the owner or his representative take full responsibility before a boat is moved or lifted.

The last parameter to take into account is the time actually allocated for regatta inspections: this is always decided in advance and usually before the number of boats to be inspected is known.

From the above, it follows that the actual inspection process is a compromise, based on what is desired and what can be accomplished with the available resources: having less time or fewer assistants than the ideal will inevitably lead to fewer items to inspect, and if there is no space protected from the elements, it will be impossible to measure hull weight accurately and therefore this control, or radius of gyration measurements should not even be attempted.

L.3 General Guidelines

The following is a set of guidelines that may help when preparing and organizing inspections, especially at the higher levels (4 & 5 as in L.2.2).

- **Production line method (Measurement stations).** Since the time available for measurement is invariably short it may be necessary to adopt a production line method of carrying out the work with one measurer (with enough assistants) running one measurement station where for instance, the hull templates would be applied. The boat is then passed on to the next station and so on. If the boats are being moved from one station to another, the distance which they have to be moved should be kept as short as possible, as this is less tiring for those involved in moving the boat, and results in less time being wasted. A flow from entrance to exit not requiring boats to back up is strongly to be desired. For large fleets it may be possible to have parallel production lines, which may share some stations.

It may also be possible to control some of the items concurrently, but that depends on how the Class rules are written: as an example, if the hull weight is specified, it may be controlled at the same time as the rig or the appendages are checked at their assigned station. But if the boat weight is to be controlled, then one has to wait until these components have been completely checked before putting them back on the hull to measure the boat weight.

- **Timetable.** This depends on the available (allocated) time, the number of participating boats and the desired level of inspection. Many regatta inspectors divide the allocated time into blocks and allocate these to each competitor, others allow the competitors to sign up for the time block they prefer, while a third option, which has the greatest flexibility, is to allow competitors to sign up in an order and to keep them informed about your progress and their position in that order.
- **Number of Qualified Measurers + assistants.** This has to be agreed beforehand with the Organizing Authority (OA) and is obviously related to the level of inspection desired. Given the fact that inspection may include fundamental measurement, and that this will be inevitable in case a part does not comply with the rules when controlled using go/no go gauges, there must be at least one qualified official measurer.
- **Special inspection forms** using the yes/no system instead of the actual measured values. There may be separate sheets for each item, such as sails, mast, hull, safety equipment etc. with clear identification on each sheet. A binder, with transparent pockets for the sheets for each boat facilitates the organization of the paperwork.
- **Jigs, templates, measuring rods etc.** should be used wherever possible; measurement tapes etc. should be avoided as much as possible because they require trained people to handle them properly, in contrast with a go/no go gauge.
- **Sail measurement** should be performed on tables except when the size of the sails prohibits that option.
- **Special equipment** should be brought in by the Class or IM (swing test apparatus, hull templates etc.). A variety of scales for hull weight, crew weight, mast weight, tip

weight, anchors etc. and corrector weights are required and are best supplied by the measurer but may be provided by the OA. They must be calibrated on site and of the right span and resolution for their purpose.

- **Measurer's boat** (when needed for post-race on the water checks) should be requested from the OA in advance. By the time of the event all available powerboats are allocated and it is very difficult to find additional ones. A RIB is strongly recommended as most competitors will not allow other types near them on the water. In some cases it may be possible to share a boat with the judges, command being transferred to the inspector after boats have crossed the finish line and are being inspected.
- **General plan** for the actual inspection process (timetables, items to be inspected, and requirements regarding area, tables and equipment to be provided by the OA etc.) should be developed by each Class for their major events, to ensure uniformity in methods and procedures. A list of these required facilities, equipment and volunteers should be sent to the OA a few months before the event. Several classes have developed excellent guides that may be found in most cases on their websites. One of the tasks an IM is expected to carry out is to check and try alternative methods in order to improve the inspection process for his class, share experiences and knowledge with the other IMs of his class, and make suggestions for improvement in class rules.

In addition to the general guidelines, a person in charge of a multi-class event inspection should consider the following:

- “Important” items (so more likely to need checking) vary from one class to another
- The advice of each Class Chief Measurer, who is a recognized expert and should be able to offer proper guidance on what to look for, should be taken into consideration when planning the inspection system.
- The number of items to inspect depends heavily on available resources: manpower, facilities, current measurement issues of each class and of course the allocated time: In the case of problems, one has to reduce the total number of inspected items, or the number of boats that will be inspected, or the desired level of inspection.

L.4 Equipment Inspector's Responsibilities

Before accepting a measurement committee appointment, one has to ensure that

- One has no conflict of interest. The ISAF ROC is the body that decides in case of doubt
- One can commit for the whole duration of the event
- For a Multi-Class event, one feels one can manage all the classes!

One has to decline the invitation if there is any problem!

Having accepted the appointment, one has to:

- Obtain and review the draft versions of the NoR, sailing and measurement instructions, approving and finalizing those parts that affect inspection.
- Contact the relevant Class Chief Measurer, to make sure he has the latest information on the Class inspection procedures, current class rules and all other relevant documents. In addition, one must ensure that one's toolkit includes all the required tools and equipment; it is highly unlikely that all the required items will be found at

the venue: chances are that either the quality will be below standard or many things will be missing. It is too late to find this out on arrival.

- Normally the OA appoints a measurement coordinator, who should be contacted to be given guidance and instructions for the necessary preparations.

Pre-event Responsibilities of the Event Chief Measurer (Inspector)

- Review all documents and send the final versions to the OA
- Liaise with OA on logistics:
 - Housing
 - Transportation
 - Equipment provided by OA and Class
 - Measurement facilities (ashore and on-water)
 - Manpower requirements
 - Measurement (Inspection) team arrangements

Everything that will be needed must be specifically asked for in advance, and a chief measurer (inspector) must make sure that the available facilities (as proposed by the OA) meet the class/his requirements; if necessary he should ask for photos, plans etc. or even a site visit well in advance of the event.

Planning considerations

The number of days allocated for inspection and the number of participating boats gives an indication of the average inspection time per boat. For that, one needs to take into account realistic start and finish times, and also time for lunch breaks. The beginning of the first day is almost always slow, so allowance should be made for this as well.

If the average time calculated as above is not satisfactory for the desired level of inspections, then the inspection level should be lowered for the whole fleet. It is also possible to keep the desired level for part of the fleet –especially if there is a way to rank the boats- and lower it for the rest, even to level 1 if necessary.

Slot allocation varies between classes, with systems ranging from open timetables where individual teams can choose the slot they prefer (Finn, 470 etc), to fixed ones that specify exactly the order of inspection. The latter method works well in classes like the 420, where national teams are managed by a team leader or head coach, and thus complete national teams are inspected as a group. The team leader or coach is instructed on what to prepare and what to avoid during the inspection of the first boat and then he can go and prepare the rest of the team boats.

Manpower requirements depend on the number of items to be controlled and on the way these controls will be performed during each time slot: items that can be checked in parallel obviously require different teams. As an example, a dinghy class inspection includes sail, rig, appendage and hull inspections. The available time per boat is 10 minutes, so for that time frame all stations should run in parallel. If the same class is to be inspected at the Olympic level, the time slot can be 45 minutes and in that case rig and appendage stations may be run in sequence by the same team, because the hull station will take at least 35-40 minutes to finish hull shape measurement, before requesting the rig and appendages to perform boat weighing. A crucial part of boat weighing is the

inspection for extraneous items and water, as well as careful lifting and arranging of the hull (plus rig), so adequate time and volunteers should be assigned to this station.

Normally, a sail station is handled by two persons, one of which should be a trained measurer. The same is true for rig stations, while a dinghy appendage station may be manned by only one person.

The hull station usually handles weight control, but may also include hull shape, weight distribution and appendages (for keelboats), so the number of people varies, but usually there must be at least two persons assigned. In addition, it is highly recommended to have a dedicated secretary to handle and collect all relevant papers (measurement and inspection forms, certificates etc.).

The chief measurer (inspector) should avoid direct involvement with any measurements as much as possible, concentrating instead on controlling the team and checking cases that require expert judgement. He will also perform all fundamental measurement in cases where equipment fails the go/no go gauge inspection.

It is advisable to use the most experienced local inspector for “pre-inspection” of the boats, to ensure that boats entering the measurement area are ready for inspection: hulls and equipment dry and with no extra items, all papers present and in order, various parts of equipment in the as required condition (e.g. sails out of spars, appendages separated from hull etc.). This operation is critical in avoiding unnecessary delays when boats arrive in an unprepared state.

At the Venue

An event chief measurer (inspector) should always plan to arrive early, having at least one day set for preparations before the first day of inspections. This is absolutely necessary when doing level 4 or 5 inspections.

Once there, he should:

- Meet the local measurer/coordinator as soon as possible.
- Ensure that the facilities and equipment the OA provides are what he had requested. Finalize the arrangement of the measurement stations in the best possible way.
- Unpack all equipment and start preparing the tables, templates etc. Check that the scales are working and that they are certified and calibrated.
- Check that the sail stamp and ink, and the equipment stickers cannot be easily removed and will survive the whole regatta.
- Visit the club offices, checking that they have printed the required forms and other documents. He should also check that there is a measurement notice board very close to the inspection area, for all relevant information to competitors including the inspection timetable.

By mid-afternoon, everything should be in place; then,

- The assistants should arrive, to have their station assignments and to receive specific instructions on their job.
- To train the team, one or more of the local team boats should be taken through the inspection process.
- All tables, templates etc. should be tested carefully before the actual inspection day comes: any errors found will be rectified before they cause any harm. Training the team in the afternoon before the first inspection day is always a good idea!

- Measurement team training should go on for as long as needed. If the process must be repeated the next morning, it will certainly delay the whole inspection procedure.

L.5 Measurement team Management

Unlike Juries, Measurement teams almost always include people with little or no measurement /inspection experience. To manage the team properly, the chief measurer must always keep that in mind: specifically, he must be patient, and explain clearly what he wants from them; he must let them understand that he is the only authority in the team, and that he calls the shots. Mistakes are likely to happen, but he must keep his composure at all times and behave as an ISAF Race Official.

In addition, the chief measurer should allocate the team members to each station: to do that efficiently he should ask about their preferences, but also consider their individual abilities / experience. For example sail, spar and hull weight stations are each manned by two persons, so he should take care to combine one experienced member with another of less experience, but not to put two members of low experience together.

Unlike Judges and Race Officers, Inspectors are in direct contact with all competitors and their coaches. In all cases, the whole measurement team should be friendly, fair and impartial (this includes giving the right appearance, when for example competitors from the local Clubs are to be inspected by assistants who may be their friends).

The chief measurer should be willing to answer any questions and certainly to explain his decisions. Especially when dealing with “difficult” competitors or coaches, he should be patient but firm, avoiding arguments and personal confrontations; the object is to keep calm, civil, be prepared and explain as best as he can. It is very important to show that the chief measurer knows his job and the rules and that he only wants to provide a level playing field.

On the water, the Measurer’s boat should be visible, always staying close to the fleet before the start and between races: a competitor may need to show damaged equipment to get authorization for replacement. All moves of the boat should be planned ahead, avoiding at all costs competing boats. At the finish, it is vital to pick a spot that will give easy access to finished boats without obstructing the RC or Media boats. An inspector should not interact with any competitors unless he is actually inspecting their boat, or requested to assist as a rescue boat. As in the case of Judges, there should be two inspectors on each measurer’s boat, so that there is always a witness and a driver to control the powerboat while one inspector is checking things inside a competitor’s boat.

Finally a chief measurer should be keeping notes for further analysis: when something goes wrong, one has to find the reasons behind that, before reaching a solution for next time. If a particular class rule is not clear or not easy to apply, or a new development in equipment exploits the rules, then the class authority must be informed.

L.6 Inspection methods and tools

While hull and in many cases hull appendage inspection methods are not that different from normal certification control (sections H and I) except for the need to record actual values in the latter case, rigs and sails are inspected in a more efficient manner by using methods described in the respective sections J and K.

L.7 Special Inspection issues

L.7.1 Personal / Portable Equipment

Personal Flotation Devices

Sailing instructions usually state that wet suits will not be considered to be adequate personal buoyancy and therefore competitors have to have approved Personal flotation devices (PFDs).

Requirements and standards vary from one country to another and therefore it is not possible to give firm statements on what may be accepted. However, if personal buoyancy is required then it must be an item of equipment which has been made as a Personal flotation device. Personal buoyancy shall comply with the specific class rules. Where not specified in class rules, personal buoyancy compliance with ISO 12402-5 (level 50) which has replaced CEN 393, or any other equivalent standard may be accepted. Inflatable buoyancy aids are only permitted if the Class Rules specify them.

The equipment inspector should not accept a PFD if it is damaged in any way which can affect its performance or which would allow it to come off the wearer, or move, thus reducing its effectiveness. In any case, an equipment inspector should not improvise trying to “test” a PFD. There are specific tests (ISO 12402-9) that are beyond the scope of an event inspection, therefore the inspector should limit himself to checking the label/markings and visual inspection for modifications by the owner.

Trapeze Harness

There are often two requirements for a trapeze harness or hiking aid: maximum weight and positive buoyancy.

Ballasting the harness with lead or other material in order to bring it up to the maximum weight is not permitted. To check for positive buoyancy the harness should be immersed in water. As no time for floating is specified it is sometimes asked how long the harness shall be able to float. The requirement is that it shall not sink.

Some modern trapeze harnesses are combined with a PFD which has the buoyancy on the back, so an unconscious wearer would end up face down. The legality of such combination devices should be checked with the class.

Anchor

Unless the Sailing Instructions, National Authority prescription, or the class rules prescribe otherwise, the racing rules require a boat to carry an anchor and chain or line when racing.

If an anchor is required, the class rules normally specify the minimum weight of the anchor and the length of line required.

If an anchor is slightly underweight it is normally accepted that its weight can be increased by attaching additional weight. If this is done the weight has to be added in such a way that it is permanently fixed (glued with resin) and furthermore does not impair the anchor's efficiency. An anchor should be able to hold the boat, which effectively means it has to be either a commercially available anchor or to be similar in its design.

The anchor line has to be used only as the anchor line and shall not be used as spinnaker sheets etc. as well.

The stowage of the anchor is sometimes considered in the class rules but, if it is not, the measurer should check to see that it is not stowed in one of the buoyancy tanks. Buoyancy tanks are part of the safety equipment and should not have to be opened at any time while the boat is sailing.

Paddle

If a paddle is required to be carried it shall be capable of performing its function satisfactorily. A paddle may be dismantled for stowage provided it is made especially to do so and is adequately strong. The minimum length of the paddle is taken as the overall length, and not the length of each part. Some classes specify the weight of the paddles.

Bucket

One or more buckets or self-bailer may be prescribed by the class rules to bail water from the cockpit, while remaining tied to the boat by a line.

Hand pump

If a hand pump is required by the class rules it should be capable of pumping water from the bottom of the bilges to the outside of the deck.

Bow Numbers and sponsor advertising

In the event that the OA requires bow numbers and regatta sponsor advertising, the OA often requests the measurement team to supervise the placement of these items on the bow of the boat. It is useful to have rags/paper towels and acetone for removing wax, and a template (easily made of cardboard) for placement of the bow numbers and sponsor advertisements.

Regatta Control Stamps, Stickers and Forms

Accurate records, namely complete sets of regatta control forms for each boat, with identification numbers for each piece of equipment are essential, and teams should not be allowed to leave the measurement area without signing their form that all regatta stamps and stickers are in place on their equipment. This is essential proof if a boat is later found with equipment with no sticker.

L.7.2 Crew weight

The RRS have always, except perhaps in this era of canting keels, prohibited movable ballast except for the crew. Sailing upwind in heavy winds it is clear that extra weight on the rail or on a trapeze is very advantageous, while in drifting conditions downwind it is a liability. So there is a compromise and for many dinghy classes the relatively narrow range of competitive crew weight has led to self-regulation, and is one reason for having both the Laser and Finn in the Olympics as the light and heavyweight men's single handed classes. However in general, for displacement classes it is advantageous to have a heavier crew, and many classes have introduced crew weight restriction rules. Perhaps the best known example of a heavy crew's advantage was Dennis Conner's 830 pounds (377 kg) team at the Etchells Worlds in Freemantle in 1990; they were first at the

weather mark in every race. The Soling middlemen and Star class crews were often chosen for their weight as well as skill prior to the class adopting a weight rule.

L.7.2.1 **Class Rules Approaches**

The weight control rules and procedures should ideally ensure that all competing crews are below the prescribed weight limit while racing, without encouraging behavior which could have adverse health effects or discourage participation due to a too onerous procedure. Lack of participants or attendance at the social events has a serious effect on sponsors who are now so essential to regattas! Any threat of post-race control severely inhibits the sailor's intake of fluids during the racing and thus many classes only allow pre-race controls to be implemented.

Different classes have adopted different rules and procedures for implementing control of crew weight and the following are some typical examples:

Weighing all competitors only once prior to racing:

Melges 32 Class Rules

C.7.1. The minimum number of crew is 5.

C.7.2. The total crew weight on board while racing shall not exceed 629kgs.

This weight shall be taken with the crew dressed in normal underclothes only. Crews shall only be weighed during the registration period prior to racing. Re-weighing shall only take place if a valid protest shows that the pre-race weights were false.

C.7.3. Competitors shall not wear or carry clothing or equipment for the purpose of increasing their weight.

This type of rule has the disadvantage of encouraging crash dieting prior to the weigh-in and then binging before racing, both behaviors being very unhealthy. Furthermore, this allows heavy crews to then sail while over the weight limit, while naturally light crews cannot bulk up to the same extent, thus defeating the purpose of the rule.

This particular rule is interesting in that it explicitly states that the crew SHALL NOT EXCEED 629kg while racing, but prohibits the measurer from enforcing it. It also seems to require the measurement to be made with crews in their underclothes as the word shall is used. Logically the rule should require "The total crew weight at control and when dressed in at least normal underclothes shall not exceed 629kgs".

The 2010 Melges 32 World Championship allowed for crew weight to be measured as far as nine days before the first race, allowing teams with the opportunity to increase their crew weight before racing began. With the goal of the team to be 60-70 lbs over while racing, one team gave members a "target weight" which was typically 3-15 lbs below their normal weight. However, based on the rule, as long as the crew weight information was accurately recorded, and the scale equipment was not found to be faulty, the time of weigh in was the ONLY time a crew had to weigh no more than 629kg. On the surface this practice of sailing over the class crew weight maximum would seem unethical but the class rules do not seem to regard this practice illegal, although it contravenes RRS 2 and Section C of the rules that state "It is the Owners responsibility to see that his boat complies with the class rules and relevant RRS at all times".

The Dragon Class rule is similar:

Dragon Class Rule

13.10 There shall not be more than 4 persons on board while racing. A boat shall compete with the same number of crew throughout an event.

13.20 The use of any apparatus or contrivance (other than fixed hand holds on the inside face of the cockpit coaming) the purpose of which is to support or assist in supporting a member of the crew outboard or partially outboard is prohibited. When hiking no part of the crew's body between the middle of the thigh and feet shall be outboard of the sheerline.

13.30 Except when excluded by the Sailing Instructions, the total weight of the crew shall not exceed 285 kg. The weight shall be taken with the crew wearing lightweight clothing. If a crew has been officially weighed in immediately previous to the regatta, re-weighing during the regatta shall not take place unless there is a change of crew.

However, this rule appears to leave it open to the Organizers whether to weigh before the regatta or during the regatta, only specifying that re-weighing during the regatta shall not take place if there has been a weighing immediately previous to the regatta. It is again interesting that re-weighing to provide evidence for a protest is prohibited.

The Star class also recommends weighing at registration but does allow weighing during or after the event at the discretion of the organizing authority provided the competitors have been informed of this. The Star Class generally elects to use a "weight at any time" rule that ensures the helm and crew stay below the required weight for the duration of the event. Due to the crew having a greater effect than the helmsman the crew's weight is multiplied by a factor of 1.5 in the Star class rule. In the unlikely event of the skipper being significantly heavier than the crew they would be prohibited from changing places while racing? The range of Star sailors weights are far wider than any other Olympic class and this is one of the reasons that sailors can come from just about any other Olympic class and compete in the Star.

Star Class Rule

31.1.3 For Gold, Silver, And Blue events, Fleet Qualifications, the Olympic Regatta, all respective Olympic Trial Regattas and all International Sailing Federation Grade One Ranking Regattas, the total crew weight is limited according to the following formula:

S=Skipper's weight, C=Crew's weight in kilograms:

$$C = ([100 - S] / 1.5) + 100 \qquad \text{i.e. } 1.5C + S = 250 \text{ kg}$$

Weighing before the event is required. Weighing during or after the event is optional at the discretion of the organizing authority as posted in the Notice of Race and Sailing Instructions. Crews found to be in violation of the rule shall be subject to disqualification from any race sailed on the day of the violation.

The Etchells class system:

Etchells Class Rule

7.1 Crew — There shall be three or four persons on board when racing and their total combined weight as measured wearing light clothing shall be no more than 285kg. For any sanctioned event a boat shall sail with the same crew throughout.

7.2 Wet Clothing — The total weight of clothing and equipment worn or carried by a competitor shall not be capable of exceeding 10 kilograms when weighed as provided in

RRS Appendix H. This amends RRS 43.1(b) for the IECA. [Note: The 10kg includes footwear and other clothing below the knee.]

Although this rule does not explicitly specify the procedure for implementing it the current practice is to have pre regatta weighing of all competitors, and then a reweighing the whole fleet before racing mid-week or weigh a (semi) random sample of 15% of competitors, who are chosen by the jury every morning prior to racing, with no post-race crew weight check (the percentage can be at the discretion of the class or the race organizers). Semi random means a truly random sample with, however, the possibility of including potential medal winners if they have not been subject to previous random checks. Selected crews being notified by posting a notice and being given a 1-hour time window in which they must present themselves for weight check. Crews may present themselves more than once during this 1-hour period. This procedure strongly encourages crew to be under the weight limit while being much less onerous and requiring less time and effort to implement than a daily weighing.

Weighing all competitors every morning within a specified time period prior to racing, with no post-race crew weight check was used by the Yngling for the Olympics and is perhaps the fairest system. However, this requires significant resources and for large fleets becomes impractical and a significant burden for the competitors. Note that the crew weight control procedure is not specified in the Yngling class rule, so it must be clearly stated in the NoR and SIs as was done for the 2004 Olympics

Crew weight equalization as illustrated by the 49er Class which eventually abandoned them.

C.6 Crew Weight Equalization

(a) The crew weight shall be determined at registration as the combined weight of the crew members wearing shirts and shorts, swimwear, or the equivalent. The crew members and the clothes shall be dry when weighing.

(b) The hull shall carry crew corrector weights and have its wing widths adjusted as follows:

<i>Crew weight</i>	<i>Corrector weight</i>	<i>Wing width per side</i>
<i>148 kg</i>	<i>5.0 kg</i>	<i>maximum</i>
<i>148 to < 160 kg</i>	<i>2.5 kg</i>	<i>50 mm</i>
<i>> 160 kg</i>	<i>nil</i>	<i>100 mm</i>

(c) Official crew corrector weights shall be attached to the rudder gantry.

Although this type of rule is based on physical principles and in theory allows sailors with a wide variety of weights to compete on a level playing field in raked or winged boats, the effort to implement it has proved not to be worth the theoretical gain, and most sailors prefer to race equal boats.

L.7.2.2 Event Inspection of Crew Weight

The following are recommended at regattas where crew weight control is part of regatta inspection:

It is clear from the above examples that most class rules do not specify the procedure for implementation of their crew weight rules and therefore the first duty of a regatta inspector is to contact the class and organizing authority and negotiate an agreed

procedure, which should then be announced in the NoR and SIs. The NoR should clearly specify the place and time period(s) for crews to present themselves for weighing as well as when and when competitors are liable for weight checks. Crew weight protest procedures should also be prescribed.

There are classes where making weight means weighing more, not less. The Lido 14 class, most beach catamaran classes and the new AC 45 have minimum crew weight rules.

The only crew weighing procedures that provide reliable adherence to the rule are; a daily weigh in, or random weighing of crews as they step ashore after a day's racing. No negotiation, simple exclusion. Soft rule enforcement leads to bad events and bad feeling among competitors.

The ultimate choice of procedure needs to reflect the attitude of the class and the nature of the event.

For those classes which allow only one weighing is recommended that all competitors should be weighed mid event rather than at registration. This limits any dieting and at least ensures that all competitors meet the weight limit on that day. Procedures for any further checking should be agreed with the RC and posted.

The possibility of giving any crew that wishes to, the opportunity to weigh in the morning prior to racing and thus protecting them against protest for that day should be considered.

A competent measurer, who understands the serious implications of a crew being overweight, should be appointed to perform the crew weighing, and in the case of women's events it may be preferable if this measurer is a woman. If possible a second measurer should be present to witness the weighing and check the record keeping.

It is common practice to use inexpensive "bathroom" scales for weighing crews, and this is only acceptable if the calibration has been checked, the resolution is ± 100 g, and a standard weight of typically 70-80 kg is available to confirm the calibration and reproducibility on a daily basis. For calibration inexpensive 20 kg bar bell weights can be obtained at most fitness centers but must then be weighed using a certified scale.

At some regattas scales have been made available to competitors prior to racing in order that they can check their wet clothing weight, and such opportunities may now be used for crew weight check. Many teams have their own scales and check before a regatta but these scales may not be in calibration. If scales are made available then the official scales should be used, under measurer supervision, in order to ensure correct results. Such data have in the past been presented in protest hearings.

The weigh station should include a desk and power for a laptop, for record keeping.

The weight station should be in an enclosed draught free room (not a tent), for privacy, and to restrict the entry of unauthorized spectators. In view of the fact that competitors may wish to present themselves in minimal clothing a changing room in the vicinity of the weigh station would be an added convenience.

The crew weight control, which can lead to a DNS for a crew in contention, can be of significant interest to the press, other competitors and teams and should not become a

spectator sport. Only other members of the crew, the measurers and possibly a team manager should be allowed to be present.

Unless otherwise specified the clothing worn by the competitors may, at the discretion of the competitor, be as minimal as is consistent with propriety.

Although the class rules only specify the total crew weight and it is slightly more precise to weigh all crew members together this is generally impractical, so individual weights are measured then added and recorded. As crews often do not present themselves together they must be clearly identified and should sign a paper record agreeing to the time, date and recorded weight.

It is convenient to use a spreadsheet for recording crew weights, flag any total crew weight that is illegal and keep track of daily variations. However, there should also be a paper record of the data.

Lists of all crew members for each boat should be made available and their eligibility to race posted. However, all individual weights should remain confidential.

Any crew member not presenting themselves within the prescribed time period should be reported to the RC.

In the event that the total crew weight is found to be higher than the maximum allowed the skipper/team manager should immediately but confidentially be informed. The whole crew should then be given the opportunity for a second weighing, but only one, before the end of the weight measurement period. It is recommended that a member of the RC or of the Jury be invited to be present for this second weighing.

In the event that the illegal weight is confirmed this should be reported to the RC, who will then deal with it in accord with the procedure for measurement infringements.

Although it is generally regarded as a cheap shot to protest on a measurement rule such as crew weight, such protests if any have to be lodged during the normal protest time. A crew's weight can be changed fairly quickly if it is known that it is under protest, however, any weight checks should only be performed at the request of the jury.

Scale Resolution limitations

Most Class crew weight rules state the maximum crew weight only to the nearest kg, e.g. 205 kg, and this is somewhat ambiguous as it could imply that the rounded off weights add to the given maximum, or that the actual value must be below this maximum as measured to high resolution, i.e. 205.000 kg. Digital scales only record the measured quantity to within ± 0.5 of the LSB, or in some cases where the LSB is only 0 or 5, to ± 2.5 , so the latter should be avoided.

When using a scale with a LSB of 0.1 kg the weight of a competitor is only known to within ± 50 gm. For example a crew of actual weight 72.049, 83.049 and 50.042 kg would be recorded as $72.0+83.0+50.0=205.0$ kg and so just legal, but would actually weigh 205.14 kg and thus be illegal (as determined by a scale with a LSB of 0.01 kg). If the crew all stood on such a 0.1 kg LSB scale together they would also be illegal, as it would read 205.1 kg! Thus the result depends on the resolution of the scale!

This assumes that the scale calibration is perfect, but it could also be off by 0.5 LSB. For example when the 70.00 kg check weight is put on the scale the calibration is such that it

should have read 69.951 kg but rounds to 70.0 kg, and so looks correct. However, it actually reads 49 gm low so someone who weighs 70.048 kg would also give a reading of 70.0 kg. Thus the example crew could actually weigh up to 205.3 kg if the scale calibration is off by the maximum amount

Such small differences will have no effect on the racing and are smaller than the daily crew weight changes, but can cause problems in the jury room unless these limitations of digital scales are understood. In order to avoid problems in the jury room the interpretation of the rule, and the resolution of the scale to be used, should be clarified before the regatta.

L.7.3 Wet clothing

The wet clothing control, which is implemented after racing, (in according to RRS appendix H) should (even if carried out using the same facilities and by the same measurement team) be a completely separate procedure from the crew weight control. It should not produce any evidence on which a crew weight protest could be launched. The selection of crews for post-race wet clothing check should be totally independent of that for pre-race crew weight check, even if this sometimes leads to the same crew being selected for both checks.

Points to bear in mind are similar to those for crew weight with the following added:

- It is vitally important to follow selected competitors in from the race course to ensure that they do not jettison or exchange clothing. Top Olympic sailors have been known to capsize on the way in! No unsupervised contact with coaches etc. should be allowed prior to control.
- Wet clothing controls, which take place after racing, can lead to disqualification. It is therefore essential that the weighing is accurate and precise.
- Scales of resolution $\pm 10\text{g}$ are recommended.
- The scale should be water resistant and have a separate display so the results can be kept confidential.
- It is strongly recommended that a certified 10 kg weight is available to confirm the accuracy of the scale, either daily before weighing and/or after a weighing that may lead to a protest. Such confirmation of the accuracy is essential for the jury.
- The procedures to be used for wet clothing control are specified in Appendix H and should be precisely implemented.
- The competitor is allowed to arrange the clothing on the rack but it is recommended that only the measurer is allowed to subsequently ensure correct draining.
- A stop watch is sufficient to time the 60 s draining period but the lifting tackle should be such that the clothing can be rapidly lifted at the start.
- The scale should be continuously read so that the weight at 60 s can be precisely recorded.
- The facilities for the weighing should provide for the data to be kept confidential. This can become a major problem if a Gold medal is on the line (Finns in 1984) as press and TV will make efforts to record the procedure.
- Changing rooms providing privacy for undressing should be in the near vicinity.
- A large bath or container for dunking the clothing as well as a hose and water supply must be available.
- Only the competitor, a team manager and the measurers, preferably two, should be allowed to be present.

- It should be noted that RRS H2 allows the competitor three weighing attempts but does not allow the measurer to require a third weighing if he judges the second one to be in error!

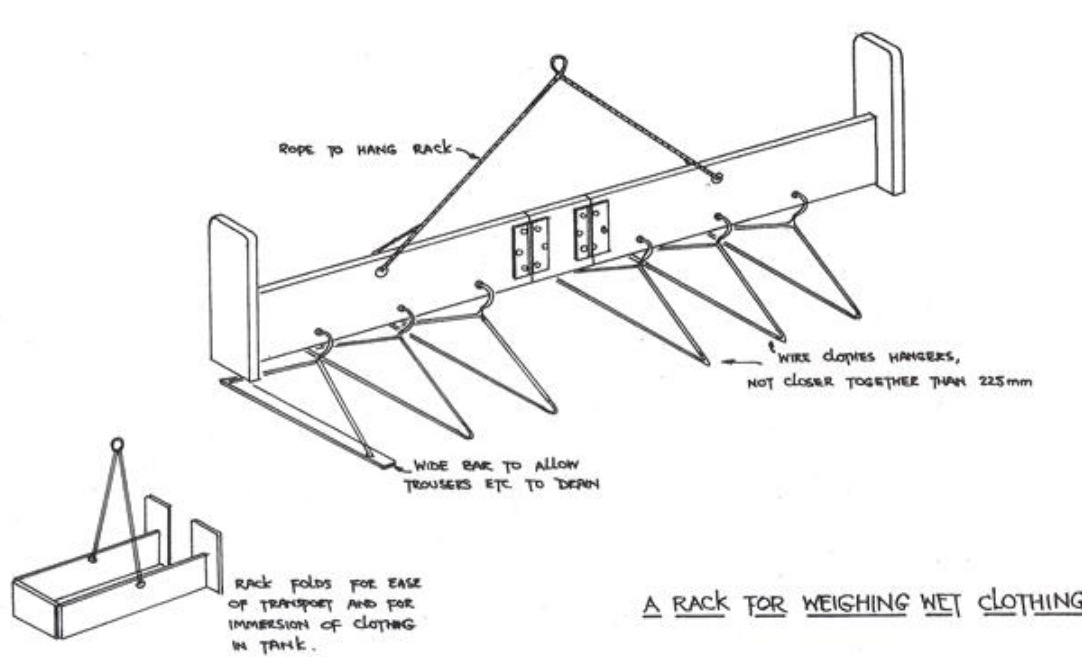

L.8 Equipment Inspection Procedure Examples

Over the years, Classes have developed their own systems to manage event inspections at their major events. In some cases, there are highly detailed documents that outline the procedures and the required facilities and resources, and also special instructions meant for the competitors to help them prepare their equipment for inspection. Some examples of such documents are presented in this chapter and they are meant solely for information.

L.8.1 Measurement Preparation & Outline of Stations: OPTIMIST Class

Basics

The Measurement Area must be close to the boats parking area and the perimeter must be free of cars, vans and trolleys in order to allow a good access to it. It is especially important that the circulation of cars with trolleys do not cross the perimeter in order to avoid problems with the flow of the teams to be measured. It has to be possible to restrict access to the Area to only those to be measured, by means of doors or fences; as well as the organization of flow channels of boats on the perimeter.

The Measurement Area must be indoors with a surface of not less than 200 m². The entry and exit of the Area should be on opposite sides of the hall in order to allow a proper flow of the team and equipment to be checked. This small detail is fundamental for a fast and well-controlled process. Inside the Area, there should be two lines of measurement control: one for the charter boats (fast way) and another for the rest of the boats.

It should be possible to securely close the Area during lunch time and also at night. Electric Light and power for scales and computers will be needed.

During the races (once inspection is finished), the Area can be used for other purposes, but at least 60m² must remain available for the Measurement Committee in order to perform the post-race controls (weight of boat, measure replacement sails, etc.).

The Measurement Committee shall have a rubber boat. The suitable size of it is 6m length and 40Hp with a central helm in order to allow a safer control but also the towing of competitors for control ashore. The boat shall have a small mast for the Measurement flag and also a proper anchoring system and be capable of acting as a rescue boat in emergencies.

Control of Equipment: Stamps and Stickers

The stamp for the sail must be of a size between 5x5 and 10x10cm approx., shall include the Championship logo and/or the words "Measurement Control". If the stamp is small, is better not to use too many letters on it. As waterproof ink dries fast altering the shape of the stamp, it is necessary to have at least 3 stamps.

The ink to be used for the sail and at the markers must be waterproof and must be tested before the event.

Waterproof markers shall be Staedtler Lumocolor F or similar. As the spars are usually black, there's a need for waterproof markers with white, silver or golden ink.

The plastic stickers shall be 6x3cm size including the logo of the Championship and/or the words "Measurement Control" over transparent background in order to allow a visible signature under the sticker. The number of stickers needed per boat is 6. If the number the entries are 250, there's a need of 1500 stickers so the recommendation is to prepare about 2000 of them in order to avoid problems.

Measurement Stations:

Code letters and colours of each station have been taken according to those used on former World Championships. The helpers describe below must be competent and available during all measurement days. In case of illness, injury or not full-day availability there must be additional helpers which must be trained before starting measurement. The person in charge of each station shall be able to communicate in fluent English.

Station A: Measurement Secretariat. Check-In

Function: Receive, check and classify the documentation shown by the Team Leader one hour before the measurement of his or her Team starts. The person in charge must be fluent in English and if possible in other languages (French, Spanish, German, etc...). Once verified the documentation, the measurement forms for the Championship must be fill in (include on them the National Code and Sail Numbers) which will be used on the other stations. Statistics of the used equipment shall be produced on that station (Access or Excel File including Sail Number, manufacturer of hull, sail, spars and foils)

Staff:

1 Responsible shall be experienced on the measurement procedures, but also with the documentation of the Optimist Class. It is suitable to have a peaceful and nice person on that job because it will have to deal with the team Leaders.

1 Helper: it will help the Responsible and be in charge of the entry to the Measurement Hall (check if the boats and equipment were dry or not, buoyancy bags inflated but out of the straps, mainsheet removed from blocks, towing line, foils and spars out from covers, etc..)

Total: 2

Equipment:

- One table-desk with 2 chairs.
- 2 chairs for the Team Representatives (Coach and Team-leader).
- 50 Folders or similar
- Measurement Forms (approx. 275 sets)
- One Board (cork or similar)
- Pens, pencils, paper, stapler, etc.

Station B: Hull Weight. Green Measurement Form

Function: Check mould numbers, sail number on the mast thwart and ISAF Building Fee sticker (which must be the same than those stated at the green form by the Measurement Secretariat). Check that the hull complies with the weighing specifications (dry, no lines, buoyancy bags out of the straps, etc...) and weight them. Check the accuracy of the scales. It is important to place that station on a levelled concrete (not over wood or grass floors) and protected from the wind.

Staff:

1 Responsible

1 Helper

Total: 2

Equipment:

1 table with 2 chairs

1 Digital scales for 35Kg. Also suitable digital scales for 50Kg with a resolution of 50g.

1 Certified Weight of 35Kg

1 Master list with all the controlled boats including weights and correctors if needed.

Wooden pieces of 300, 200, 100 & 50 g (up to 10 or 15Kg).

Pens, waterproof markers, paper, etc.

Station C: Hull Control. Green Measurement Form.

Function: Check the items previously defined by the IODA T.C. A random measurement control of boats will be made, which may include: hull shape and materials, positioning of fittings, etc. Place the control sticker and signature on the mast thwart

Staff:

2 Responsible which will be members of the T.C. (bottom and deck)

2 Helpers

Total: 4

Equipment:

- 1 IOD'95 Measurement Bar, IODA templates for IOD'95
- 1 Table with 2 chairs.

- 1 Metal detector.
- 4 Wrestles with foam. Approx. height: 700mm.
- Pens, pencils and paper.
- Waterproof markers.

Station D: Spars Control. Yellow Measurement Form.

Function: Check mast, boom and sprit. Verify that each piece has the sail number but also the serial number. Check the measurement bands at the mast and boom, which shall be permanently fixed.. Check the positioning of holes and fittings and also the length of the sprit. Place the control sticker at each piece

Staff:

1 Responsible

1 Helper

Total: 2

Equipment:

- 1 table (3x1 meters) for the measurement templates
- 2 chairs.
- 2 wrestles or a small table to place there the equipment before measurement.
- 1 Punch for metal
- 1 Teflon hammer.
- Pens, pencils and paper
- Waterproof markers

Station F: Sails Control. Red Measurement Form.

Function: It is the most complicated station due to the number of items to be controlled. For that reason the station is divided in 2 areas (2 sail measurement tables). It is important to fill in the form the sail button number of the sail. Check material of the sail and reinforcements, length of leech, luff, foot, diagonals, concavities and convexities at the leech, sail width, sail measurement band, foot mid-point, etc. Check positioning and dimensions of Class Logo, Batten pockets, reinforcements, sail numbers, etc.

Staff:

2 Responsible which must be experienced on Optimist Sails measurement

2 Helpers

Total: 4

It is very important a good coordination between the responsible and the helpers at that station in order to allow a fast and accurate measurement process.

Equipment:

- 2 Tables of 3.5 X 2.5 meters, which must be completely flat and smooth (like melamine). If possible, the table should be made with one single board with reinforcements underneath. Height of the tables 90cm
- 2 Sail Measurement Templates (shall be ordered at the IODA Secretariat)
- 1 table with 3 chairs.
- 1 Micrometre.

- 2 Flex meters (tape measure) class II of at least 3 meters length (Stanley or similar)
- 2 or 3 Official stamps of the Championship (between 5 x 5 y 10 x 10 cm. approx.).
- Waterproof ink for cloth (like STK Berolin R9 or similar)
- 3 Pads for ink.
- Waterproof markers
- Pens, pencils and paper

Station F: Foils Control. Blue Measurement Form

Function: Check the shape of foils using the templates. Check the materials, positioning of fittings of the rudder and centre of gravity of the Daggerboard. Verify the weight of foils, serial numbers and manufacturers. Place the stickers on checked equipment.

Staff:

1 Responsible

1 Helper

Total: 2

- Equipment:
- 3 tables of 1.5 x 1 meters.
- 2 chairs.
- 1 Daggerboard Measurement Template.
- 1 Rudder Measurement Template.
- 1 Digital scales for 2 Kg. Also suitable, digital scales for 5kg with a precision of +/- 10gr.
- Pens, pencils and paper.
- Waterproof markers.

Station G: Check-Out. Orange Measurement Form.

Function: Check the colour forms previously filled in at each station. When everything is found to be correct, then issue the “Regatta Measurement Approval” which will allow the competitor to participate at the event with the equipment checked by the M.C. When one or more items are found to be not OK, re-measurement will be needed. When possible, re-measurement time will be at the end of the day, or in periods with not heavy load of work. Once finished the measurement, all forms must remain on the Check-out station organized by Teams and in folders. A good co-ordination between Check-in and Check-out is needed

Staff:

1 Responsible

1 Helper

Total: 2

Equipment:

- 1 Table with 3 chairs.
- Forms: Regatta Measurement Certificate
- Re-measurement Schedule
- Pen, pencil, paper

- 1 Master list (which shall include the names of the Teams and competitors that did finish the Measurement).

OTHER NEEDS:

- Radio and/or phone for communications with the Race Office, Race Committee Boat, International Jury.
- Photocopier when the Race Office is not nearby
- T-shirts and/or caps to identify the measurement committee members
- Refrigerator with water and other soft beverages.
- Wastepaper baskets
- Acetone and cloth
- 1 Table of 2x2 meters outside the hall for repairs.
- Transparent tape (scotch tape)

L.8.2 Measurement Regulations: 470 Class

L.8.2.1 General requirements

All boats (including their spars, sails and equipment) entered for the Championship shall be inspected in accordance with the Class Rules and any special rules contained in these Measurement Regulations, the Notice of Race, and the Sailing Instructions. Pre-race measurement inspections as defined in 1.2 here below, and measurement inspections at random during the Championship, shall be organized.

Pre-race measurement inspections shall include, at least:

- full inspections (as defined in section 2) of boats used by crews within the Top 30 of the ISAF Men's ranking list or within the Top 20 of the ISAF Women's ranking list,
- full inspections (as defined in section 2) of 10 other boats per category, chosen at random by the Regatta Chief Measurer,
- for other boats, inspections limited to the weight of the complete boat (Class Rule C.6.1), to the conformance of the hull and sails to the measurement certificate and Class Rules B.4.2, C.17.3, C.17.4, D.1.4, G.2.2 and G.3.1 (identification marks on hull and sails), to Class Rules C.12.3(a)(2)&(12) and C.13.3(a)(5)&(6) (stoppers and limit marks on spars), and to specific inspections requested by crews for their own boats.

The International 470 Class Association, with the agreement of the Organizing Authority, may decide on a case-by-case basis to apply full pre-race measurement inspections as defined in section 2 to all boats.

In accordance with R.R.S. 78, competitors are responsible for maintaining their boat in accordance with the Class Rules (for the purpose of R.R.S. 78, competitors are considered to be the owners).

L.8.2.2 Pre-race measurement inspections

The boats shall be presented for measurement inspections with the full equipment as scheduled by the Measurement Committee. Locations and schedule for measurement inspections are posted on the official measurement notice board.

Each boat shall be presented for measurement inspections as follows:

- the mast shall be down and the boat shall be accompanied by mast, boom, spinnaker pole, one set of sails, rudder, tiller, centreboard and all other equipment required on board by the Class Rules for the purpose of weighing,
- the mast shall be complete with the spreaders in position and with the standing rigging taught and secured at the lower measurement band. Halyards shall be in the sailing position. The mast head wind indicator, if any, shall be removed,
- the hull shall be empty, in dry condition, all hatches and covers removed for inspection,
- the hull shall carry the identification marks required by the Class Rules,
- hull, sails, spars and equipment shall carry all the measurement marks, bands, stickers and labels prescribed in the Class Rules.

According to the Class Rules, the number of sails, spars and foils which may be approved during measurement inspections shall not exceed:

1 mainsail, 1 jib, 1 spinnaker,

1 mast, 1 boom, 1 spinnaker pole,

1 centerboard, 1 rudder.

Sails without the sail button required by Class Rule B.4.2, or without a sail number or the 470 emblem, will not be inspected. As specified in the Class Rules, all sails supplied by competitors shall have been certified in accordance with the Class Rules before being presented for measurement inspection.

Each boat shall be presented for measurement inspection with her Measurement Certificate including the completed Measurement Form. These may be retained by the Regatta Chief Measurer for the duration of the event. If the completed Measurement Form is a photocopy, its authenticity shall be confirmed with an original stamp and signature from the issuing authority.

Any item which is not in dry condition satisfactory to the Regatta Chief Measurer to be correctly inspected, and any item which is not found in compliance with the Class Rules during inspections, shall be presented again later on to the Measurement Committee, at the Regatta Chief Measurer's disposal, and as long as it is not satisfactory.

The weight of clothing and equipment worn by a competitor may be self-checked using the official equipment, during the time scheduled on the official notice board.

Only the team manager or his delegate and the boat's crew are allowed to be present during the boat's measurement inspection. At least one of these persons shall be present and shall be authorized to remedy any deviation from the rules or to withdraw the boat from the event.

Unless authorized by the Regatta Chief Measurer, repairs or alterations to boats, equipment or sails shall not be made in the measurement inspection areas.

All pieces of the boat's equipment subject to inspection are marked with an official measurement inspection mark or sail stamp (waterproof ink), preferably on the port side. Some items may receive two inspection marks, one in a readily visible position when afloat, and a second in a position protected from wear and tear (after the items have been

marked, the sticker/stamp may be signed and numbered by the Measurer and the number recorded on the Regatta Measurement Inspection Form to prevent exchange of equipment from one boat to another one). After the items have been marked, the crew leader of each boat is required to sign the Regatta Measurement Inspection Form declaring that all inspected pieces of equipment have been properly marked and that none of the marked pieces of equipment will be changed without the prior approval of the Regatta Chief Measurer. Any such piece of equipment not so marked shall not be used. If through wear and tear, a mark starts to become obliterated, the fact shall be reported to the Measurement Committee in order that the mark may be replaced.

L.8.2.3 Pre-race measurement inspection proceedings

Team managers or competitors shall apply for the allocation of a measurement time slot to the Chief Measurer. It is recommended to post on the official measurement notice board at 1400 hrs of the day before the first day of pre-race measurement inspections a time table over the two days (Junior Championships) or three days (World and European Championships) for pre-race measurement inspections, with free slots in sufficient number that competitors may choose and book by writing their sail number on the list (each boat inspection should last around 10 minutes). Boats and equipment as indicated above shall be presented at the designated time.

The Regatta Measurement Inspection Form (on which date and time allocated for measurement inspection may be added) shall be collected by the representative of the entered boat at the Race Office.

The representative of the boat shall be at the measurement inspection area with boat, sails, spars and equipment and with the Measurement Certificate, the Measurement Form and the Regatta Measurement Inspection Form at the designated time.

At each measurement inspection station the representative of the boat shall present the Regatta Measurement Inspection Form to be filled in each time an inspection has been passed.

L.8.2.4 Changes to inspected boats and equipment

After boats, spars, sails and equipment have passed through pre-race measurement inspections and been stamped, they shall not be removed from the regatta area without the written permission of the Regatta Chief Measurer.

Alterations: after boats have completed pre-race measurement inspections, no alteration shall be made except for the normal designed adjustment of fittings and equipment.

Repairs: any competitor wishing to make repairs to his boat, her sails or equipment, after she has passed through pre-race measurement inspections shall make an application to the Regatta Chief Measurer. If permission is granted, the concerned competitor shall arrange a time for such repairs to be approved by the Measurement Committee.

Replacements: any application for a replacement of boat, sails, spars or equipment to be used shall be submitted to the Regatta Chief Measurer. Approval can only be given when it can be satisfactorily demonstrated that the sails, spars or equipment are severely damaged, were not deliberately mistreated, and cannot be repaired satisfactorily. New pieces of equipment shall be inspected by the Measurement Committee before use. However, when a piece of equipment is lost or damaged immediately prior to a race and is replaced or repaired, the competitor shall notify the Race Committee prior to the start of the race, and then make an application to the Regatta Chief Measurer as described here

above as soon as he arrives ashore after the race has finished, and within the protest time limit.

L.8.2.5 Measurement inspections during the Championship

Any boat, her spars, sails, equipment and crew's clothing and equipment may be inspected at any time during the regatta by the Measurement Committee, and any deviation reported by the Race Committee to the International Jury, on Regatta Chief Measurer request.

After each race competitors (selected at random by the Measurement Committee or chosen by the Race Committee or the International Jury) may be informed by a member of the Measurement Committee that they have been elected for measurement inspection on the water or ashore (special pre-assigned area for such inspections may be defined). If the latter, the boats shall be inspected as soon as possible after coming back ashore.

At least one representative of the crew is required to be present during the entire inspection period of the boat. When the Measurement Committee representative is not convinced that the boat would exceed in a dry condition the minimum weight required by Class Rules due to the weight reached in a wet condition during inspection, he may impound the boat for weighing the following morning before race.

When a measurement varies from that prescribed by the Class Rules, or when the Measurement Committee representative has reason to believe that a piece of equipment has been altered, repaired or replaced without prior approval, the Race Committee, on Regatta Chief Measurer request, reports the matter to the International Jury for hearing and decision.

L.8.3 Laser Class Inspection Guidelines

Equipment list

The following equipment is required to carry out a quick and effective inspection check of a laser, either rigged or unrigged:

- Notepad, inspection forms, folders.
- measurement stamp / waterproof ink / stamp pad (2 minimum and one with the logo of the event used only to stamp the sails), permanent markers, paint markers (useful for coloured spars and distinctive from usual markers), pens and pencils
- steel measuring tape
- ILCA template: rudder angle, centreboard and rudder thickness, sail numbers template + electrical tape to be used to correct rudder angle
- Measurement jigs for spars and battens.
- copy of measurement and inspection guide
- copy of laser class rules (handbook of the year which also contains the bye laws)
- Plastic tape, 1 large table (2 x 3 metres) + 1 smaller one. (the tape can be used to mark out batten length templates on the table. the tables are useful for sail folding and for the rudder pin to reduce the angle of 78 degrees)
- Tent (ideally measurement at major events should take place under cover to protect from rain and sun.)

Personnel and Roles

Chief Measurer:

- Oversees the measurement team.
- Does the paper work with the help of a secretary.
- Interprets the rules when required.
- Makes the final decision over to waive a piece of failed equipment.

4 – 5 person minimum assistants team if less than 200 and double if you have 400 sailors.

Spars; Sail and boards; Hull and control lines

- For running a national championship it is worthwhile to organize an assistant chief measurer who knows as much about measuring as you. Everyone deserves a break away from the inspection area and it also gives you the opportunity to discuss a point of contention if the Laser Class Chief measurer cannot be contacted.
- If you expect more than 50 – 60 boats per day of inspection, plan on having 2 inspection teams, both with a full set of jigs and templates and additional set of stamps and stamp pads. From a competitor's point of view, spending 3 hours in a queue to be inspected is very annoying. It should take 5 minutes to completely inspect a Laser.
- Give a number to each sailor starting at 1; use that number on all identified equipment you will stamp and sign. This number can also be used by the organisers for numbering trolleys, meal ticket, etc.

Measurement Location

Ideally an undercover area should be used, where both the measuring teams and those waiting to be measured are under cover. Boats should be able to approach from one direction and then continue to move off without interfering with boats already in line. An undercover car park, walkways beside the club or the undercover boat storage area can all be considered as good locations.

Handling Paper Work

It is suggested that each competitor is assigned an inspection sheet (see the Laser Championship Measurement and Inspection Form), prior to the regatta the competitors name and sail number are recorded on the sheet and the sheets are filed alphabetically or national letter if it is an international event. When a competitor is about to be measured, the form is retrieved marked off and re-filed.

When a competitor does a late entry, a new sheet can be started and then filed in the correct location.

The regatta chairman should be made aware of all boats with advertising particularly if there is a potential conflict with official sponsors of the regatta. (check any conflict with ISAF advertising regulations)

The person entering the competitors' data should be made aware of all requests to sail with alternate sail numbers, so that any potential problems with missing bow numbers, does not result in a boat not being able to be identified.

Non-compliant Equipment

Depending on the level of the championship you have to use your discretion or not. It is not the same approach for a local event than a national event, a regional or world event. Although equipment that technically fails equipment inspection should be corrected or should not be used in competition, sometimes a value judgement can be made which allows competitors to compete with this equipment and this could apply at local event. One example is a person showing up in an old boat, likely to be a local who is unlikely to be competitive, with a boom that has fittings that have been moved because of corrosion and are no longer in the correct position. A bit of discretion may save you from being more unpopular than required.

When it comes to using your discretion, the most important consideration is whether the competitor will gain an advantage from using equipment that is illegal, over other competitors. If they gain an advantage the equipment should not be passed. An example is with sail numbers, if a competitor sail numbers are not within the prescribed tolerance, the measurer should ask themselves, is the sail number clearly visible and roughly in the right place? Yes, pass it. No, the competitor has deliberately moved the numbers, as close to possible to each other and the leach of the sail, so they cannot be detected over the starting line, it fails and the numbers should be moved. Once again, this should apply to local events and make it educational and understandable to the sailor that he must fix it if he goes to a national regatta and for the next regatta.

If you do fail some equipment, make suggestions to the competitor on their best option on how to fix it. In some cases it may be an idea for you to fix it for the competitor.

If a piece of equipment is waived through, the competitor should have the problem clearly explained to them. They then should be informed how to correct the problem and that piece of equipment should be corrected before the next regatta they attend. Ideally in a case like this, they should just go and correct, before using the equipment in the regatta they are being measured for. You can apply this to local events only.

Notes on the Measurement and Inspection Form

All items on the measurement and inspection form should be checked. However, the number of inspection personnel and number of competitors may restrict you to a more “lesser” check. ILCA strongly recommend doing as complete a check as possible.

Cheating is an issue that the ILCA takes very seriously. Not everything a competitor does to their boat should be considered cheating, but competitors may do certain changes to their boat, without knowing it's illegal. In case of serious cheating, please explain it on the measurer report form you will address to the ILCA chief Measurer



INTERNATIONAL MEASURERS' MANUAL

SECTION M

Measurement Protests

M	Measurement Protests	
M.1	Introduction	M 2
M.2	Right to Protest	M 2
M.3	Relevant Rules and other Documents	M 2
M.3.1	RR 78	M 2
M.3.2	RR 64.3	M 3
M.3.3	RR 43	M 5
M.3.4	RR 69 Gross Misconduct	M 5
M.3.5	Class Rules and ERS	M 5
M.3.6	Notice of Race and Sailing Instructions	M 6
M.4	Other issues	M 6
M.4.1	Acceptance of a Measurement Protest	M 6
M.4.2	Protest Committee's Responsibility	M 7
M.4.3	Expert Witnesses and Evidence	M 7
M.4.4	Damaged Equipment	M 7
M.4.5	Re-measurement	M 7
M.4.6	Appeals	M 8

M.1 Introduction

Measurement protests are in most cases initiated as a result of post-race inspections. They are often the cause of much anxiety and emotion because of the inference that the owner or person in charge has knowledge, or should have had knowledge of the rules breach.

Measurers acting as inspectors should be aware that when making a report to the race committee, there will be no alternative other than to protest the boat. A measurer should bear this in mind and may consider discussing the matter informally with the chairman of the protest committee before making a formal report, particularly if the deficiencies are in respect of many boats. Also the equipment inspector should know that unless the Notice of Race or Sailing Instructions permit alternative penalties, even a simple class rule breach will mean disqualification.

The entire process of a measurement protest is controlled by only a few basic rules. Competitors, race and protest committees, and measurers/inspectors are all required to abide by these rules.

M.2 Right to Protest

A Measurer / Equipment Inspector may discover issues on a boat that appear to breach the rules. Before the racing starts normally he will request the boat crew to correct any such situations. However after racing starts he has different responsibilities as a member of the Race Committee. His role changes so that he initiates the process for some Race Committee protests. Measurement protests can be initiated by another boat or by the Race Committee, (normally based upon a report from an equipment inspector / measurer) under rule 60.1, 60.2 and 78.3, or by the protest committee. The rules do not give a Class Association, National Authority or the event equipment inspector or measurer the right to protest on their own. Being an International Measurer makes no difference here! And obviously, an event inspector has no right to disqualify a boat or rescind its entry.

Usually, when an Equipment Inspector makes a report to the race committee, the RC chairman will delegate him the task of preparing the protest; therefore it is essential that he understands the relevant parts of the RRS as, in the event of a measurement protest, the procedures given in the RRS must be followed correctly. RRS 61 deals with the requirements so a protest can be considered valid. Typically, the Race Officer will represent the Race Committee as a party to the hearing, and call the equipment inspector as a witness during the hearing. In some cases the Race Officer might ask the inspector to represent the Race Committee during the hearing; therefore he needs to know how to behave and how to support his case in front of the Jury.

M.3 Relevant Rules and other Documents

M.3.1 RR 78

RRS 78 states that:

78.1 A boat's owner and any other person in charge shall ensure that the boat is maintained to comply with her class rules and that her measurement or rating certificate, if any, remains valid. This means that it will always be the owner's responsibility, or person in charge, to keep the boat compliant.

78.2 When a rule requires a certificate to be produced or its existence verified before a boat races, and this cannot be done, the boat may race provided that the race committee receives a statement signed by the person in charge that the boat has a valid certificate. If the certificate is not produced or verified before the end of the event, the boat shall be disqualified from all races of the event.

Many classes reduce the time limit to present the certificate in order to avoid having to deal with this at the end of the Championship. When done, it is clearly stated in the Notice of race or in the Equipment Inspection Instructions.

78.3 When a measurer for an event decides that a boat or personal equipment does not comply with the class rules, he shall report the matter in writing to the race committee, which shall protest the boat.

Where a measurer makes a report to the race committee in accordance with the requirements of RRS 78.3, such report should be in writing, giving details of the sail number and plaque number, name and owner of the boat in question, together with details of the class rule or rules and interpretations considered defective, at what time these were noted as being defective, what action if any has been undertaken by the owner or representative and whether or not, in the opinion of the measurer, the defect was in existence before and/or after a race.

M.3.2 RR 64.3

64.3 Decisions on Protests Concerning Class Rules

- (a) When the protest committee finds that deviations in excess of tolerances specified in the class rules were caused by damage or normal wear and do not improve the performance of the boat, it shall not penalize her. However, the boat shall not race again until the deviations have been corrected, except when the protest committee decides there is or has been no reasonable opportunity to do so.
- (b) When the protest committee is in doubt about the meaning of a class rule, it shall refer its questions, together with the relevant facts, to an authority responsible for interpreting the rule. In making its decision, the committee shall be bound by the reply of the authority.
- (c) When a boat disqualified under a class rule states in writing that she intends to appeal, she may compete in subsequent races without changes to the boat, but shall be disqualified if she fails to appeal or the appeal is decided against her.
- (d) Measurement costs arising from a protest involving a class rule shall be paid by the unsuccessful party unless the protest committee decides otherwise.

This rule specifically permits a yacht time to put right any damage or wear and tear which has caused her not to comply with her class rules, provided that her performance is not improved as a result of this.

It is a matter of judgement whether performance will have been improved but, for instance, a dinghy would normally not be disqualified if, through being dragged up a slipway, part of her keel band had a cross section less than that required by her class rules.

Likewise a protest committee would not be expected to disqualify a boat whose buoyancy equipment had been rendered ineffective by a collision for which she was not responsible.

It is the responsibility of the Measurer/Equipment Inspector to prepare the material required for the Protest Committee to make a sound judgement. The information must meet the requirements of RRS 61.2 and initially be complete enough to fulfil the requirement of describing the incident sufficiently to meet the requirements of rules 61.2 (a) & (b). This report should record only the facts - i.e. the measurements or details of the shape of the item concerned and, if requested, the wording of the class rules. For example it could be as simple as “Boat X was inspected at the conclusion of race #5 at 4pm and the spinnaker pole was found to be 5mm longer than allowed by the class rules”.

A measurer/inspector should not try to explain to the Jury the meaning or interpretation of either class or racing rules.

The measurer/equipment inspector will then have to be prepared to show to the protest committee how the measurement was taken, why it was not within tolerances and what the relevant class rules are. It should also be noted that convention and precedent only exist in cases of the class rules, the Equipment Rules of Sailing and official rule interpretation by the authorised authority or racing rule appeal cases. The fact that something was permitted at the last major event of the class does not mean that it should be considered as a precedent for future events.

After listening to all of the available evidence, if the protest committee decides there is no reasonable doubt about the interpretation of the measurement rule, then it must decide the case. The protest committee must do this, even if the decision does not meet with the approval of the measurer who made the report or the authority responsible for interpreting the class measurement rule.

If the protest committee is still in doubt about the interpretation of a measurement rule, then rule 64.3(b) requires that the protest committee refer the questions, and relevant facts to an authority responsible for interpreting the rule. This authority will usually be the ISAF, a Class Association’s technical committee, a National Authority or a rating authority. Normally this authority is not the equipment inspector, but sometimes the equipment inspector happens to be also the chairman of the class technical committee. Once the protest committee refers the question, it is bound by the measurement authority’s reply.

Additionally if an International jury is appointed, 70.5 states that there shall be no appeal from an International Jury. Rule 64.3(c), which allows a boat to race until she appeals the decision of the protest committee, then becomes moot.

In almost all cases the protest committee should be able to decide the protest using the process outlined in rule 64.3. Evidence concerning the accuracy of the measurement and the interpretation of the rule is presented by the competitor and the equipment inspector or measurer.

M.3.3 RR 43

RRS 43 COMPETITOR CLOTHING AND EQUIPMENT

43.1

- (a) Competitors shall not wear or carry clothing or equipment for the purpose of increasing their weight.
- (b) Furthermore, a competitor's clothing and equipment shall not weigh more than 8 kilograms, excluding a hiking or trapeze harness and clothing (including footwear) worn only below the knee. Class rules or sailing instructions may specify a lower weight or a higher weight up to 10 kilograms. Class rules may include footwear and other clothing worn below the knee within that weight. A hiking or trapeze harness shall have positive buoyancy and shall not weigh more than 2 kilograms, except that class rules may specify a higher weight up to 4 kilograms. Weights shall be determined as required by Appendix H.
- (c) When a measurer in charge of weighing clothing and equipment believes a competitor may have broken rule 43.1(a) or 43.1(b) he shall report the matter in writing to the race committee, which shall protest the boat of the competitor.

43.2 Rule 43.1(b) does not apply to boats required to be equipped with lifelines.

When checking for clothing and equipment according to Appendix H inspectors should be aware that if a sailor is found to have a piece of equipment for the sole purpose of increasing their weight, for example a lead belt, it will be a gross breach of RRS 2 and then require a report to the race committee. The protest committee or international jury might then decide to initiate action under RRS 69.

M.3.4 RR 69 Gross Misconduct

Action or the promotion of action under RRS 69 is a very serious matter and should only be entered into after due consideration of all the factors involved in the alleged gross misconduct. To date there have only been two types of incidents where such action has been undertaken involving measurement or a measurer.

The first was where an equipment inspector, whilst carrying out his duties, was verbally abused by a competitor. In such a case only the measurer can judge the degree of abuse and whether or not this warrants promotion of action under this rule.

The second was where there was an undisputed case of either measurement cheating or fraudulent certification marking. In such cases, provided that there is no doubt whatsoever, the measurer should not hesitate to make a report to the race committee that could prompt the protest committee or international jury to initiate action under RRS 69.

In any case when filling out a report to the race committee that involves cheating or verbal abuse the measurer or equipment inspector should always list RRS 2 among the rules breached.

M.3.5 Class Rules and ERS

Class rules spell out the details of how a boat must measure and/or rate. They usually include administrative provisions, owners' responsibilities, etc., in addition to the details about measurement. Almost no set of rules is perfect, and class rules are no exception. It is these imperfections that lead to some measurement problems. There may be loopholes

that permit a skilled owner or designer to stay within the wording of the rule and gain an advantage. Some class rules indicate that perceived loopholes shall be considered to not be loopholes. However it is often the case that rules are clear and through simple error or a desire to build to the maximum tolerance allowed that mistakes are made and violations occur.

Although the rule and measurement procedures appear complex, a protest committee can usually understand them with a little effort and some informed assistance from an expert witness, usually a measurer or class rule administrator.

Class association measurement and championship rules govern a class. The definition of rules in the RRS also state that rating or handicap rules are “class rules”. Remember that these rules do not empower a class association to disqualify or otherwise penalise boats during an event. Such action can only be taken by the protest committee or international jury.

The ISAF Equipment Rules of Sailing is sometimes a valuable tool to settle questions about measurement procedures as are Class documents.

M.3.6 Notice of Race and Sailing Instructions

Sailing instructions may include provisions for the handling of measurement questions. They often include everything from pre-race procedures and measurement checks to alternative penalties (other than DSQ).

If the race organisers intend to take an active role in checking measurement and enforcing compliance it is important that any special rules and procedures be written in the Sailing Instructions (and Notice of Race if necessary). Such advance planning could eliminate problems that might develop later and save the protest committee time in clearly identifying the race organisers’ authority and role in measurement questions.

The appointed chief measurer (regatta inspector) should work closely with the Organizing Authority to ensure this is done well in advance.

M.4 Other issues

M.4.1 Acceptance of a Measurement Protest

The protest committee must first determine whether the protest is valid; the requirements of rule 61 must be met.

- Rule 61.2(a) states you need to identify the protestor and protestee.
- Rule 61.2(b) states that the incident, including where and when it occurred has to be described, so for a measurer or an equipment inspector it is imperative to describe this as objectively as possible in his report to the Race Committee.
- Rule 61.2(c) requires the protestor to identify the rule believed to have been broken. A protest stating only that, “the boat doesn't measure”, or that, “she is too fast for her rating”, should normally be rejected, because it does not meet the requirements of rule 61.2(c). Stating the broken rule but not describing the incident does not meet the requirements of rule 61.2(b) making the protest invalid.

M.4.2 Protest Committee's Responsibility

When a protest has been lodged under rule 78 and in accordance with the requirements of rule 61, rule 64.3 becomes operative and controlling. The protest committee may not automatically hand the matter to someone else. It must hold a hearing, find the facts, determine whether it can interpret the rules, and if so, decide the question. Unless it is unable to interpret or apply the rules, it must decide the protest without referring the question to a qualified authority.

Rule 63.6 requires that the protest committee take evidence from the parties and such other evidence as it thinks necessary. The rules expect the protest committee to obtain the evidence it needs to decide the protest.

M.4.3 Expert Witnesses and Evidence

In many instances the measurer acts on behalf of the Race Committee as the protestor, in addition he is also the expert witness. Only in an unusual situation will the protest committee be required to call another expert witness in order to resolve a measurement protest. If an additional expert witness is required it is usually essential to have someone who is thoroughly familiar with the class rules and procedures to assist the protest committee as an expert witness. Class Measurers can be helpful, and boat designers can be expert witnesses when there is no conflict of interest. Remember that witnesses, no matter how expert, are just witnesses. The protest committee makes the final decision.

M.4.4 Damaged Equipment

A competitor will sometimes request permission from a protest committee to use an alternative sail or other piece of equipment when one that was previously measured and limitation marked has been damaged -especially when Class Rules limit the number of sails etc. that may be used during an event. The measurer may be asked to give evidence as to whether or not, in his opinion, the extent and cause of the damage justifies a replacement. In such a case the measurer may decline to give evidence respectfully pointing out that the cause and extent of damage to the sail and its possible future use is not a matter dealt with by class rules or measurement but a matter for subjective consideration.

M.4.5 Re-measurement

When an equipment inspector or a measurer is available, and the protest alleges complex infringements, the protest committee may wish to order measurement checks or even re-measurement. This is within its power and its obligation to 'take such other evidence' as it needs to make a decision.

Nothing in the rules gives the owner of one boat an absolute right to demand that another boat be re-measured. The decision to order or request re-measurement is a matter for the protest committee alone (or the organizing authority if the Sailing Instructions give it that power). Note however, that the losing party may have to pay for re-measurement and any measurement costs.

A boat disqualified under a measurement rule may continue to compete in subsequent races without making changes to the boat, provided that she states in writing that she intends to appeal, provided an appeal has not been denied (rule 70.5). If she fails to appeal or the appeal is decided against her, she will be disqualified from all races.

M.4.6 Appeals

The right of appeal is dealt with by RRS 70. This permits a race committee to appeal the decision of a jury provided that the race committee was a party to the protest. This would be the case if action had been taken under RRS 78.3 and the protest hearing was not undertaken by the race committee itself. An equipment inspector/measurer and a Class Association have no right of appeal..



INTERNATIONAL MEASURERS' MANUAL

SECTION Z

Glossary, Conversion Factors & Material Data

Z	Glossary, Conversion Factors and Material Data	
Z.1	Glossary and Abbreviations	Z 2
Z.2	Conversion Factors	Z 13
Z.3	Mass Density of Some Substances (t/m ³)	Z 14

Z.1 Glossary and Abbreviations

For the definitions see also “The Sailing Dictionary”, Joachim Schult, Ed. Adlard Coles Nautical, London)

	English	Français	Italiano	Español	Deutsch	Português
101	Abaft	sur l'arrière	A poppavia	A popa	achterlich	A popa
102	Abeam	par le travers	Al traverso	Por el través	querab	Pelo través
103	Accuracy	Exactitude		Exactitud		presisão
104	Afloat	à flot	Galleggiante	A flote	schwimmend	A flutuar
105	Alloy	alliage	Lega	Aleación	Legierung	
106	Amidships	au milieu (du bateau)	A mezza nave	Crujía	mittschiffs	
107	Anchor	ancre	Ancora	Ancla	Anker	Âncora
108	Aspect Ratio	proportion	Ratio atteso	Ratio esperado	Seitenverhältnis, Streckung	
109	Astern	à l'arrière, en poupe	Addietro, a poppa, di poppa	A popa, de popa	achtern	À popa
110	Athwart	par le travers, en travers	Al traverso	transversalmente	dwars	Ao largo
111	Athwartships	en travers	Per madiere, da banda a banda	Transversalmente al barco	querschiffs	Trnasversalment e
201	Backstay	pataras, galhauban	Paterazzo	Estay de popa, backestay	Achterstag	Estai de popa
202	Bailer	écope	Gottazza	achicador	Lenzer	
203	Ballast	lest	Zavorra	Lastre	Ballast	Lastro
204	Barber hauler	rattrape	Barber	Barber	Beiholer	Barber
205	Batten	latte, balestron	Stecca	Sable	Latten	Régua
206	Beam	barrot	Baglio	Bao	Breite	
207	Bearing	relèvement, palier, coussinet	Rilevamento, Cuscinetto, Supporto	Demora	Peilung	
208	Beating	louvoyage	Navigare sui bordi	ciñendo	kreuzen	À bolina
209	Bermudian	bermudien	Bermudiano	Bermudiano	Bermuda Tackelung, Hochtakelung	Bermudiano
210	Beveling	équerrage	Smussatura, ugnatura	biselando	Schmiege	
211	Big boy (bloopers)	big boy, spinnaker asymétrique	Big boy (tipo di spinnaker)	Big boy	BigBoy, Lee Spinnaker	
212	Bilge	bouchain	Lombolo, sentina	Pantoque, Sentina	Bilge	
213	Bilge keel	quille de bouchain	Chiglia di rollio	Quilla abatible o de balance	Kimmkiel	Quilha de balanço
214	Block	poulie	Bozzello	Motón, polea	Block	Moitão
215	Block binding	estrope de poulie	Stropo per fissare il bozzello	Cinta fijada a polea		
216	Boat	bateau, canot, embarcation	Imbarcazione, barca, canotto, battello, lancia	barco	Boot	Barco
217	Bobstay	sous-barbe	Briglia, briglia del bompreso	Barbiquejo	Wasserstag	
218	Bolt	cheville, boulon	Bullone, perno. Chiavarda	Bulon , pasador	Bolzen	Passador
219	Bolt rope	ralingue	Ralinga	Relinga	Liektau	
220	Boom	bôme, gui	Boma	Botavara	Baum	Retranca
221	Boom strap	ferrure d'écoute de bôme	Stropo del boma	Aclaje de la botavara	Baumgei, Niederholer	

	English	Français	Italiano	Español	Deutsch	Português
222	Boom vang	hale bas de bôme	Paranco del boma	Trapa o contra	Niederholer	burro
223	Bow	proue, avant	Prora, prua	Proa	Bug	Proa
224	Bow rope	amarre	Cavo di prora	Cabo de proa	Bugtau	Cabo de proa
225	Bowsprit	beaupré	Bompreso	Bauprès	Bugspriet	
226	Brace	étrésillon,étrier, bras	Braccio (manovra corrente)	braza	Achterholer	
227	Breakwater	brise-lames	Para onde	Rompeolas o tajamar	Wellenbrecher	Quebra-mar
228	Bridge	pont, passerelle, château	Ponte, passerella, plancia, cassero	Pasarela, Puente	Bruecke	
229	Bridle	patte d'oie	Branca, patta d'oca, briglia	Cable de amarre	Spreiztrosse	
230	Bucket	baille, seau, bidon	Bugliolo	Cubo		
231	Bulb	bulbe	Bulbo	bulbo	Wulst	
232	Bulb-keel	bulb keel	Chiglia a bulbo	Quilla de bulbo	Wulstkiel	
233	Bulkhead	cloison	Paratia	mamparo	Schott	
234	Bullseye	hublot	Mândola, oblò	Ojo de buey		
235	Bulwarks	bastinguage, pavois	Murata, impavesata, battagliaiola, parapetto	amurada	Bollwerk	
236	Bumpkin	queue de mallet	Gruetta, buttafuori	Servioleta		
237	Buoyancy	flottabilité	Galleggiabilità, spinta di galleggiamento	flotabilidad	Auftrieb	Flutuabilidade
238	Buoyancy aid	engins de flottabilité	Salvagente	Ayuda a la flotabilidad	Schwimmhilfe	colete salva-vidas
239	Buoyancy center	centre de carène	Centro di carena, di spinta, di volume	Centro de flotabilidad	Auftriebsschwerpunkt	Centro de flutuabilidade
240	Buoy rope	orin	Cavo di boa	Cabo de baliza	Bojenleine	Cabo de baliza
241	Burgee	guidon, fanion (de club) triangulaire	Guidone	Gallardete	Doppelstander	Galhardete
252	Bustle			skeg	Eselsruecken,Skeg	
301	Cable	cable, grelin	Cavo, catena, gomina	cable	Kette	
302	Camber	bouge	Bolzone	camber	Woelbung	
303	Cam cleat	taquet coinreur	Galloccia	Mordaza	Kammklemme	Mordedor
304	Cap shrouds	hauban de fleche	Sartia	Obenques altos	Verdeckstuetzen	
305	Car	curseur	Carrello	carro	Schlitten	Carrinho
306	Cast iron	fonte (d'acier)	Gettata, fusione di acciaio	fundicion	Gusseisen	
307	Cat	capon	Capone	cat	Kat	
308	Catamaran	catamaran	Catamarano	catamaran	Katamaran	
309	Catenary	caténaire	Catenaria	catenaria		
310	Centreboard	dérive	Deriva	Orza levadiza	Schwert	Patilhão
311	Centreboard case	puits de derive	Cassa di deriva	Cajera de orza	Schwertkasten	Caixa de patilhão
312	Centreline	axe	Asse centrale	Linea de crujia	Mittelachse	Eixo central
313	Centre of flotation	centre de carène, de poussée ?	Centro di galleggiamento	Centro de flotación	Verdraengungsschwerpunkt	Centro de flutuabilidade
314	Centre of gravity	centre de gravité	Certro di gravità	Centro de gravedad	Schwerpunkt	Centro de gravidade
315	Centre of pressure	centre de pression	Centro di pressione	Centro de presion	Druckschwerpunkt	Centro de pressão
316	Certificate	certificat, acte	Certificato	certificado	Messbrief	Certificado

	English	Français	Italiano	Español	Deutsch	Português
317	Chafing patch	pièce de raguage	Pezza anti sfregamento	Parche de roce	Schamfielschutz	Protecção chafing
318	Chain	chaîne	Catena	Cadena	Kette	Cadeado
319	Chain plate	cadène	Landa	Cadenote	Puetting, Ruesteisen	
320	CHS	Channel Handicap System				
321	Check wire	câble de retenue	Cavo di ritegno	Cable de seguro	Stopper	Cabo de segurança
322	Cheek block	poulie à une joue	Maschetta di bozzello	Polea de seguridad		Moitão de segurança
324	Cheek	joue (d'une poulie)	Maschetta	cachola		
325	Chine	bouchain	Lombolo, Stellato	Pantoque		
326	Chock	chaumard	Calastra, zeppa, bietta	calzo	Klampe	Cunha
327	Chord	corde (géométrie)	Corda (geometria)	cuerda		Cabo
328	Clam (cam)cleat	taquet coinreur	Galloccia	mordaza	Kammklemme	Mordedor
329	Cleat	taquet	Galloccia	mordaza	Klemme	Mordedor
330	Clench (clinch)	étalingure	Legatura con mezzo collo	entalingar		
331	Clew	point d'écoute	Bugna	Puño	Horn, Schothorn	olhal
332	Clew outhaul	bras d'écoute ?	Alafuori di bugna	Ollado del puño	Unterliekstrecker	Olhal de punho
333	Climbing rung	échellons de mât	Piolo (di scala)	Peldaño del mastil		
334	Clinker-built	à clins	A fasciame accavallato, sovrapposto, cucito, a labbro	Construcción en tingladillo	Klinkerbauweise	
335	Clinometer	clinomètre	Inclinometro	clinometro	Neigungsmesser	clinómetro
336	Cloth	laize, toile	Tela, ferzo	Paño lona tejido	Tuch	Tecido
337	Clothing	habillement	Abbigliamento	tejiendo	Bekleidung	Tecendo
338	Cloth weight	grammage d'une toile, d'un tissu	Peso del tessuto	gramaje	Tuchgewicht	Gramagem do tecido
339	Coaming	hiloire	Battente di boccaporto, Mastra	Brazola,	Suell	
340	Coating	couche de peinture, enduit	Stato, mano di pittura	acabado	Anstrich, Beschichtung	
341	Cockpit	carlingue, cockpit	Pozzetto	bañera	Cockpit	Poço
342	Cradle	ber	Invasatura	Basada, camada, Cuna, carro		
343	Crazing	craquelures	Crinature	cuarteo	Haarrisse	
344	Crew	équipage	Equipaggio	tripulacion	Mannschaft	Tripulação
345	Cringle	patte, oeil sur ralingue	Brancarella	grillete	Legel, Auge	
346	Cunningham (eye or hole)	oeillet de cunningham	Occhiello del Cunningham	Ollado del cunningham	Vorliekstrecker	Cunningham
347	Cure	traitement, cure	Cura	Cura / vulcanizado	Verfahren	
348	Cutter	côte	Cutter, fresa	Cuter, cuchillo	Kutter	
349	Cutwater	guibre	Tagliamare	Corta aguas	Steven	
401	Daggerboard	dérive sabre	Deriva a coltello	Orza Levadiza de sable	Schwert	Patilhão pivotante
402	Deck	pont	Ponte, Coperta	cubierta	Deck	Coberta
403	Deck line	livet	Linea del ponte, linea di riferimento (bordo libero)	Linea de cubierta	Deckstrack	Linha de coberta

	English	Français	Italiano	Español	Deutsch	Português
404	Deck plate	tôle de pont	Copertura di bronzo delle aperture sul ponte	Plancha de la cubierta		
405	Density	densité, masse volumique	Densità	densidad	Dichte	Densidade
406	Depth	profondeur, creux	Profondità, altezza di puntale	profundidad	Tiefe	Profundidade
407	Device	dispositif	Dispositivo, apparecchio	Aparejo dispositivo	Einrichtung	Aparelho ou sistema
408	Diamonds	losange		Rombos	Rombus, Jumpstage	
409	Dinghy	dériveur	Dinghy, barca a deriva	Chinchorro o balandro de vela ligera	Dinghy	Barco de vela ligeira
410	Double luff sail	Voile à double ralingue	Caliorna (vela a),	Vela de doble gratil	Doppelsegel	
411	Dowel	dé, douille, clé, goujon, cheville	Caviglia	cuña		Cunha
412	Downhaul	hale bas	Caricabbasso	cargadera	Niederholer	
413	Draft	calaison, tirant d'eau	Pescaggio, immersione	calado	Tiefgang	Calado
501	Earing	empointure	Borosa (di inferitura), matafione di inferitura, inferitoio	empuñadura		
502	Event Measurer	jaugeur lors d'une régata	Stazzatore ad una regata	Medidor de una regata	Vermesser bei Regatten	Medidor de uma prova
503	Eye	oeil, piton , oeillet	Occhio	Ojo gaza	Auge	
504	Eye bolt	piton à oeil	Golfare	cancamo	Augbolzen	
505	Eylet	oeillet	Occhiello, occhiello di inferitura	ollado	Oese	
506	Eye plate	pontet		cancamo	Augplatte	
507	Eye splice	épissure		Gaza trenzada	Augspleiss	
601	Fairlead	chaumard	Puleggia, rotella di guida e di comando	guia	Klampe	
602	False keel	fausse quille	Falsa chiglia	Quilla falsa	Loskiel	Quilha falsa
603	Fastening	chevillage, assemblage	Elemento di fissaggio	fijacion	Halterung	
604	Feeder	caisson	Alimentatore	alimentacion	Tank	Alimentação
605	Fender	défense	Parabordo	defensa	Fender	Defensa
606	Ferrule	virole	Boccola, virola, ghiera	fêrula	Faser	
607	Fibre (fiber US)	fibre	Fibra	fibra	Faser	Fibra
608	Fiddle	poulie violon	Tavola di rollio	Violin	Violine, Violinblock	
609	Filler	mastic, bouche-pores	Riempimento	masilla	Fueller	
610	Fin	aileron, ailette	Aletta stabilizzatrice	ala	Finne	
611	Fin keel	quille à aileron	Ala della chiglia	Ala de la quilla	Kielflosse	
612	Fitting	accessoires, accastillage	Accessori	accesorio	Beschlag	acessório
613	Flare	dévers, renvoi	Slancio della prora, segnale a lampi di luce, segnale pirotecnico	bengala	Flackerfeuer	
614	Flush-decked	plat-pont	A ponte raso / libero	Cubierta corrida	Flachdecker	

	English	Français	Italiano	Español	Deutsch	Português
615	Foil	foil, aileron	Aletta, ala portante	Aleron		Aleron
616	Foot	pied	Piede, supporto, linea di scotta	Pie	Fuss	Pé
617	Footrope	ralingue de bordure	Ralinga, gratile	Cinchas	Liektau	
618	Fore	avant	A prua, verso prua	A proa	vorne	À proa
619	Foredeck	pont avant	Ponte di prua	Cubierta de proa	Vordeck	Coberta de proa
620	Foresail	misaine, voile d'avant	Vela di prua	trinqueta	Vorsegel	Vela de proa
621	Forestay	étai	Strallo di prora	Estay de proa	Vorstag	Estai de proa
622	Foretriangle	triangle avant	Triangolo di prora	Triangulo de proa	Vorsegeldreieck	Riângulo de proa
623	Frame	couple	Costole	Cuardena	Spant	
624	Freeboard	franc-bord	Bordo libero	Franco-bordo	Freibord	
625	Furl	ferlage, ferler		asir	bergen	
626	Furling gear	dispositif de ferlage	Dispositivo di serraggio delle vele	enrollador	Fockroller	
701	Gaff	corne	Gaffa, mezzomarinaio	pico	Gaffel	
702	Gasket	garcette	Gerlo, guarnizione	bridas	Reffbaendsel	
703	Gelcoat	gelcoat, couche de résine extérieure	Strato di resina esterna	gelcoat	Gelcoat	
704	Genoa	génois	Fiocco Genova, fiocco grande	Genova	Genua	Genoa
705	Ghoster	génois Volant	Gennaker	Buscabrisas	Gennacker	Gennaker
706	Girder	poutre, support	Trave longitudinale, supporto	Soporte, durmiente	Unterzug	
707	Girth	développement, chaîne	Perimetro contorno	contorno	Abwicklung	
708	GRP (Glass fibre reinforced plastic)	résine renforcée par des fibres de verre	Resina rinforzata con fibra di vetro	Poliester reforzado con fibra de vidrio	Glasfaser verstaerkter Kunststoff	Polister reforçado com fibra de vidro
709	Gooseneck	vit-de-mulet	Perno di rotazione del boma	Pinzote	Luemmelbeschlag	Peão de retranca
710	Grandfathering	tolérance d'ancienneté	Dispensa per età	dispensa	Altersverguetung	Dispensa
711	Groove	gorge	Scanalatura, gola	ranura	Keep, Mast/Baumnut	Ranhura
712	Gunter rig	houari	Guntero	Aparejo Gunter	Gunter Takelung	
713	Gunwale	lisse de plat-bord	Falchetta	regala	Dollbord, Scheuerleiste	
714	Guy	retenue, bras	Cavo di ritenuta, vento, ostino	Viento Retenida, guía	Gei, Niederholer	
715	Gybe (jibe US)	empennage	Virare	virar	Halsen, schiften	Camber
801	Halyard (halliard)	drisse	Drizza	Driza	Fall	Adriça
802	Hank (snap US)	manoque	Canestrello	garrucho	Stagreiter	
803	Harness	harnais	Bozzellame	harnes		Harness
804	Hatch	écoutille	Boccaporto, portella	Escotilla / Registro	Luk	Escotilha
805	Hawse hole	écubier	Cubia	Escobén	Kluese	
806	Head	tête	Testa, prua, penna	Puño de driza	Kopf	Punho de adriça
807	Headboard	têteière	Tavoletta	Tablilla cartabon	Kopfbrett	
808	Headsail	voile d'avant, foc	Vela di prua, fiocco	Vela de proa	Fock, Vorsegel	estai
809	Heeling moment	moment de redressement	Momento raddrizzante	Momento de escora	Kraengungs moment	

	English	Français	Italiano	Español	Deutsch	Português
810	Helm	barre, gouvernail	Timone, barra	Rueda/ Caña	Steuer, Ruder	Leme
811	Helmsman	barreur	Timoniere	Timonel	Steuermann	Timoneiro
812	Hike	rappel		colgarse	ausreiten	Prancha
813	Hiking racks	barres de rappel		Asas de colgarse	Ausreithilfen	Cintas de prancha
814	Hoist	chute	Elevatore	izar	hochziehen	Içar
815	Hull	coque	Scafo	casco	Rumpf	Casco
901	Inclining test	test de stabilité	Prova di stabilità	Test de estabilidad	Aufricht Test	Teste de estabilidade
902	Inglefield clip	crochet brummel		Mosquetón pequeño	Brummelhaken	
1001	Jam cleat	taquet coinreur	Tacchetto a tenaglia	mordaza	Kammklemme	Mordedor
	Jaw	machoire, ferrure de bôme	Gola del picco o del boma	Boca de crujia	Baumgabel	
1002	Jib	foc	Fiocco	Foque	Fock	Estai
1003	Jib-boom	bôme de foc	Asta del fiocco	botavara de foque	Fockbaum	Retranca de estai
1004	Jib sheet	écoute de foc	Scotta del fiocco	Escota de foque	Fockschot	Escota de estai
1005	Jib-stick	tangon de foc	Tangone del fiocco	tangon	Fockbaum	Pau de estai
1006	Jockey pole	jockey pole	Jockey pole	Jockey pole	Jockeybaum	
1007	Jumper stay	guignol			Knickstag	Estai volante
1101	Keel	quille, aileron	Chiglia	quilla	Kiel	Quilha
1102	Keelband	profil de quille	Fascia di ferro a difesa della chiglia	Perfil de quilla	Kielband	Perfil de quilha
1103	Keelboat	quillard	Barca a chiglia	Quillado	Kielboot	Barco de quilha
1104	Keel bolt	boulon de quille	Bullone di chiglia	Pasador de la quilla	Kielbolzen	
1105	Keelson	carlingue	Paramezzale	Carlinga	Kielschwein	Carlinga
1106	Ketch	ketch	Ketch	Queche	Ketch	
1107	Kicker lever	hale bas de bôme à levier	Alabasso del boma		Baumstuetze	
1107	Kicking strap	sangle de rappel		Trapa contra	Niederholer	Cintas de prancha
1201	Laminated ply	pli plastifié	Strato laminato	Paño laminado	Laminierte Lage	Pano laminado
1202	Lead	plomb	Piombo	plomo	Blei	
1203	Leading edge	bord d'attaque	Bordo di attacco	Borde de ataque	Vorderkante	Bordo de ataque
1204	Leak	fuite, voie d'eau	Falla, via d'acqua	Via de agua	Leck	
1205	Lee	côté sous le vent	Sottovento	sotavento	Lee	Sota
1206	Leech (of sail)	chête d'une voile	Caduta	baluma	Achterliek	Valuma
1207	Leech line	cargue, bouline, nerf de chête	Caricaboline	Linea de baluma	Liekleine	Linha de valuma
1208	Leech rope	ralingue de chute	Gratile di caduta	Balumero batidor	Liekleine	Cabo da valuma
1209	Length	longueur	Lunghezza	eslora	Länge	Comprimento
1210	LOA	longueur hors tout		Eslora total	Laenge ueber alles	Comprimento fora-a-fora
1211	LWL	longueur à la flottaison	Lunghezza al galleggiamento	Eslora en flotacion	Wasserlinienlaenge	Cumprimento de flutuação
1212	Life jacket (personal flotation device, PFD, US)	gilet de sauvetage	Giubetto salvagente	Chaleco salvavidas	Rettungsweste Schwimmweste, Schwimmhilfe	Colete de salvação
1213	Lifeline	filière de sécurité, sauvegarde	Cavo di salvataggio	Guardamancebos pasamanos	Sicherungsleine	
1214	Lifting keel	quille relevable	Chiglia abbattibile	Quilla abatible	Hubkiel	
1215	Lifting rudder	safran relevable	Timone abbattibile	Timón abatible	Aufholbares Ruder	
1216	Limber holes	anguiller, lumière	Anguilla, ombrinale	imbornal		

	English	Français	Italiano	Español	Deutsch	Português
1217	Line	ligne	Linea, cima	cabo	Riss	Cabo
1218	Lines	formes	Linee	cabos	Riss	
1219	Lines plan	plan des formes	Piano di costruzione	Plano de formas	Linienriss	
1220	Link shackle	maillon	Maglia di unione			
1221	Loose-footed	bordure libre	Piede (di vela) non inferito	Pujamen libre	Loses Unterliek	
1222	Luff-rope	ralingue d'envergure	Ralinga di inferitura	Relinga de pujamen	Vorliektau	
1301	Mahogany	acajou	Mogano	Caoba	Mahagoni	
1302	Main beam	maître-bau	Baglio Massimo	Cuaderna Principal	Grossbaum	
1303	Main mast	grand mât	Albero maestro	Palo Mayor	Grossmast	Mastro principal
1304	Mainsail	grand'voile	Randa	Mayor	Grosssegel	Vela grande
1305	Mainsheet	écoute de grand'voile	Scotta di randa	Escota de Mayor	Grossschot	Escota da vela grande
1306	Mainsheet track	barre d'écoute de grand'voile	Carrello della scotta di randa	Barra de escota de Mayor	Grossschot traveller	Barra de escota da vela grande
1307	Mast	mât	Albero	mástil	Mast	Maestro
1308	Mast bend controller	limitateur de flexion du mât	Limitatore della flessione dell'albero	Limitador de flexion / Cuña	Mastbiegungs begrenzer	Cunha
1309	Mast heel	ped de mât	Piede d'albero	Pie de Mastil-Coz	Mastfuss	Pé de maestro
1310	Mast-hole	étambrai	Foro d'albero, mastra d'albero	Fogonadura	Mastloch	Enora
1311	Mast partners	étambrai	Mastra d'albero	Fogonadura	Mastfischung	
1312	Mast stantion	épontille		Tintero Movil		
1313	Mast step	emplanture	Scassa dell'albero	Tintero	Maststufe	Pé de maestro
1314	mast strut	Étresillon de mât		arbotante		
1315	Mast track	rail de mât	Crema di regolazione dell'albero	Carril del Mastil	Mastnut	Carro de maestro
1316	Measurement form	protocole de jauge	Verbale di stazza	Formulario de medicion	Measurement Form, Messprotokoll	Formulário de medicos
1317	Measurement certificate	certificat de jauge	Certificato di stazza	Certificado de medicion	Messbrief	Certificado de medicos
1318	Measurer	jaugeur		medidor	Vermesser	Medidor
1319	Microspheres or Microballons	microsphères	Micro sfere	Microbalones	Microballons	
1320	Midship section	maître-couple	Sezione a metà barca	Seccion Media	Hauptspant	
1321	Mizzen mast	mât d'artimon	Albero di mezzana	mesana	Besan	
1322	Mould (mold US)	moule	Stampo, forma	molde	Form	Molde
1401	National letters	lettres de nationalité	Lettere di nazionalità	Letras de nacionalidad	Laenderkenn- zeichen	Letras de nacionalidade
1402	Nut	écrou	Dado	Tuerca	Schraubenmutter	
1501	Oar	aviron, rame	Remo	remo	Riemen, Ruderriemen	Remo
1502	Offsets (table of)	table des couples	Tavola delle coordinate delle superfici curve	Tabla de medidas	Tabelle	Tabela de medidas
1503	Outhaul	tire-bout	Alafuori	driza	Ausholer	
1504	Outrigger	outrigger	Buttafuori	arbotantes	Ausleger	
1505	Overhang	élancement	Slancio	lanzamiento	Ueberhang	
1601	Paddle	pagaie	Pagaia	Pagaya	Paddel	Pagaia
1602	Paint	peinture	Pittura	Pintura	Anstrich	Pintura

	English	Français	Italiano	Español	Deutsch	Português
1603	Painter	remorque d'étrave	Barbetta, cima di traino	Boza	Schleppleine	Pincel
1604	Peak	coqueron	Picco, penna	Puño de driza	Piek	Punho de adriça
1605	Pendant	pantoire	Penzolo	Gallardete	Stander	Galhardete
1606	Pennant	flamme, pavillon	Pennello	Gallardete	Stander	Galhardete
1607	PFD (see life jacket)	Personal Flotation Device				
1608	Pin	cheville, goupille	Perno	Pasador	Pinne	Perne
1609	Pintle	aiguillot	Agugliotto	Pivote Macho timon	Lagerzapfen	Pivô macho
1610	Pitch	brai, tanguage	Beccheggio, passo, distanza	Paso de tuerca	Stampfen	
1611	Plank	bordage, planche	Tavola di fasciame	Tablon	Planke	
1612	Planking	bordé	Tavolato	Forro	Beplankung	
1613	Plug	bouchon, tampon	Alleggio, tappo	Tapon / Tapa		Tampa
1614	Ply	pli, couche	Strato	Plegado	Lage	Tecido
1615	Plywood	contreplaqué	Legno compensato	Contrachapado	Sperrholz	Contraplacado
1616	Port	babord	Sinistra, lato o fianco sinistro	Babor	Backbord	Bombordo
1617	Primary reinforcement	renfort primaire	Rinforzo primario	Refuerzo Primario	Verstaerkung Erster Ordnung	Reforços primaries
1618	Precision	précision		precisión		Precisão
1619	Pulley	poulie	Puleggia	Polea	Block	
1620	Pulpit	balcon avant	Pulpito	Pulpito	Bugkorb	
1701	Quick release	déclencheur	Apertura rapida	Apertura Rapida	Sicherheitsoeffner	Aertua rápida
1801	Rack	crémaillère	Cremagliera	Cremallera	Rack, Halterung, Regal	Calha
1802	Rake	quête, élanement	Slancio, inclinazione	Lanzamiento	Fall, Mastfall	
1803	Rating	coefficient de jauge, de classe	Coefficiente di compensazione	rating	Verguetung	Coeficiente de compensação
1804	Rating certificate	certificat de classe	Certificato del coefficiente di compensazione	Certificado de Rating	Verguetungsmess brief	Certificado de rating
1805	Ratio	rapport	Rapporto	Ratio	Verhaeltnis	Racio
1806	Recovery line	rattrape	Cima di recupero	Cabo de recuperación	Bergeleine	Cabo de recuperação
1807	Reef band	bande de ris	Benda di terzaruolo	Faja de rizos	Reffleine	
1808	Reef cringle	oeillet de ris	Brancalella di terzaruolo	Gaza de Rizos	Reffoese	
1809	Reef earing	raban de ris	Borosa di terzaruolo	Empuñadura de Rizos	Reffauge	
1810	Reefing hook	crochet de ris	Gancio di terzaruolo	Gancho de Rizos	Reffkaken	
1811	Reproductibility	reproductibilité		reproducibilidad		
1812	Rig	gréement, gréer	Attrezzatura	Aparejo	Rigg, Takelage	Aparelho
1813	Rigging	gréement	Sartiame, manovre	Aparejos	Rigg, Takelage	Aparelhos
1814	Rigging screw	ridoir	Arridatoio	Tensor de aparejo	Spannschraube	
1815	Righting lever	couple de redressement	Leva raddrizzante	Par de adrizamiento		
1816	Righting moment	moment stabilisant	Momento raddrizzante	Par de estabilidad	Aufrichtendes Moment	

	English	Français	Italiano	Español	Deutsch	Português
1817	Ring bolt	piton à boucle	Golfare ad anello	Anilla del pasador	Ringbolzen	Anilha do passador
1818	Rivet	rivet	Rivetto	remache	Niet	
1819	Roach	échancrure	Allunamento	alunamiento	Gillung	
1820	Roach reef	bosse de ris			Abflacher	
1821	Rocker	ligne de quille	Linea di chiglia	Balancín	Kielsprung	
1822	Rod rigging	grèement au moyen de monotorons	Manovre di barre d'acciaio	Jarcia de varilla	Profilwant	
1823	Roll	rouler, roulis	Rollata, rollo	Balanceo / Rollo	Rolle	Balance
1824	Roller jib	foc à rouleau	Fiocco arrotolabile	Foque enrollable	Rollfock	Estai de enrolar
1825	Roller reefing	bôme à rouleau, (arrissage avec..)	Boma che avvolge la randa terzarolandola	Rizos enrollables	Rollreff	
1826	Rope	corde, bout	Cavo, fune	Cabo	Leine, Tau	Cabo
1827	Roving	tissage de fibres de verre, mat	Tessuto di fibra di vetro	Mecha / Tejido	Gewebe	
1828	Rowlock	toilet, dame de nage			Dolle	
1829	Rubbing strake	boudin, bourrelet	Bottazzo	Banda de Goma	Scheuerleiste	
1830	Rudder	gouvernail	Timone	Timón	Ruder	Leme
1831	Rudder blade	safran	Pala del timone	Pala del Timón	Ruderblatt	Pá de leme
1832	Rudder fitting	ferrure de gouvernail	Accessori / ferramenta del timone	Herraje del Timón	Ruderbeschlag	Acessório de leme
1833	Rudder head	tête de Gouvernail	Testa del timone	Cabeza del Timon	Ruderkopf	Cabeça do leme
1834	Rudder stock	mèche de gouvernail	Asta del timone	Cajera del Timon	Ruderschaft	Cachola de leme
1835	Runner	bastaque	Sartia volante	Burda o burda alta	Laeufer	
1836	Running backstay	pataras volant (?)	Paterazzo volante	Burdas	Loses Backstag	
1837	Running rigging	grèement courant	Manovre correnti	Jarcia de Labor	Laufendes Gut	
1901	Sag	flèche, déformation	Freccia, deformazione	Arrufo	Kieldurchbuchtung, Durchhang	
1902	Sail	voile	Vela	Vela	Segel	Vela
1903	Sailboard	planche à voile	Tavola a vela	Tabla deslizadora a Vela / Windsurf	Segelbrett	Prancha à vela
1904	Sailcloth	toile à voile	Tessuto per vela	Tejido de Vela	Segeltuch	Tecido da vela
1905	Sailmaker	voilier (ouvrier), voilerie	Velaio	Velero	Segelmacher	Veleiro
1906	Sailor	marin	Velista, marinaio	Marino	Segler	Vclejador
1907	Sail plan	plan de voilure	Piano velico	Plano Velico	Segelplan	Plano vélico
1908	Sail track		Trasto	Carril	Segelnut	Calha da vela
1909	Scantlings	échantillonnage des membrures	Dimensioni delle parti strutturali	Escantillón		
1910	Schooner	goëlette	Goletta	Goleta	Schooner	
1911	Screw	vis	Vite	Tornillo	Schraube	
1912	Seam	couture, joint	Comento, cucitura, giunzione	Costura	Saum, Naht	Costura
1913	Self-bailer	auto-videur	Auto svuotatore	autoachicador	Selbstlenzer	Auto-escoante
1914	Self-trimming jib	foc automatique	Fiocco automatico	Foque Autovirable	Selbstwendefock	Estai auto-virante
1915	Shackle	manille	Maniglia	Grillete	Schaekel	
1916	Sheave	réa	Puleggia, carrucola	Roldana	Scheibe	Roldana
1917	Sheer	tonture	Insellatura	Arrufo	Strak	
1918	Sheerguard	lisse, liston		Liston		

	English	Français	Italiano	Español	Deutsch	Português
1919	Sheet	écoute	Scotta	Escota	Schot	Escota
1920	Ship	vaisseau, bateau	Nave	Barco	Schiff	Barco
1921	Shock cord	sandow	Cavo elastico	Goma	Gummizug	Elastic
1922	Shroud	hauban	Sartia	Obenque	Want	Váus
1923	Shroud adjuster	ridoir	Arridatoio	Tensor	Wantenspanner	Afinador de váus
1924	Shroud plate	cadène	Landa	Cadenote	Ruesteisen	Váu
1925	Skeg	skeg	Skeg, calcagnolo	Skeg	Skeg	
1926	Skipper	skipper	Comandante	Patron	Steuermann	Patrão
1927	Sling	élingue	Braga	Eslinga, braga	Strop	
1928	Sloop	chaloupe, sloop	Sloop	Balandra	Slup	
1929	Snap hook	mousqueton	Moschettone	Mosqueton	Karabinerhaken	Mostão
1930	Spar	espar	Asta	perchas	Mast und Baum	Vara
1931	Spinnaker	spinnaker	Spinnaker	Spinnaker, balón	Spinnaker	Vela de balão
1932	Spinnaker Pole	tangon	Tangone	Tangón	Spinnakerbaum	Pau de vela de balão
1933	Spreader	barre de fleche	Crocetta	Cruceta	Saling	
1934	Stem	étrave	Dritto o ruota di prora	roda	Bug	
1935	Stern	arrière	Poppa	Popa	achtern	Popa
1936	Stiffening	renfort	Rinforzo	refuerzo	Aussteifung	Reforço
1937	Strand	toron	Legnuolo, trefolo	Cordon	Strand	
1938	Stretch	bordée	Bordo	Bordada / Tensar	Dehnung	
1939	Stringer	serre	Corrente, trincarino	Trancanil	Laengsversteifung	
1940	Strop	estrope	Stropo	Estrobo	Strop	Estropo
1941	Strut	étresillon	Puntello	Arbotante		
1942	Surfing	action de planer	Planata	Planear	gleiten	Surfer
1943	Swage	cosse	Stampo	pasacabos		
1944	Swallow	gorge d'une poulie	Gola della puleggia	Moton	Schwalbe	
1945	Swedish hank	mousqueton suédois	Moschettone svedese	Mosqueton Sueco	Stagreiter	Mosquetão sueco
1947	Swivel	émérillon	Tornichetto	Grillete Giratorio	Wirbel	
1948	Swivel shackle	manille à émérillon	Maglia a mulinello	Grillete Giratorio	Wirbelschaekel	
2001	Table of offsets	numérisation des couples	Tavola delle coordinate delle superfici curve	Tabla de Offsets	Tabelle	
2002	Tabling	ourlet	Guaina, vaina	Vaina	Einfassung	
2003	Tack	amure, point d'amure	Mura, punto di mura	Amura / Bordo	Wende	Amura
2004	Tackle	palan	Paranco	Aparejo	Laeufer	
2005	Tack tackle	palan d'amure	Paranco di mura	Aparejo de amura	Halstalje	
2006	Tail	Queue, fin	Coda	Cola	Schwanz, Ende	Cola
2007	Talurit	telurit		terminal		
2008	Tang	ferrure de renfort		Espiga		
2009	Telltals	penons	Segna vento	Indicadores de Viento	Windfaeden	Indicadores de vento
2010	Tensile strength	résistance en traction	Resistenza alla trazione	Resistencia a la traccion	Reckwiderstand	Resistência à tracção
2011	Tensioning rack	crémaillère	Cremagliera	Cremallera		Cremalheira
2012	Thimble	cosse	Redancia	Guardacabo	Kausch	
2013	Throat	collet, machoire	Gola	Garganta en Poleas	Klau, Gabel	
2014	Tiller	barre	Barra	Caña	Pinne	Cana de lema
2015	Tiller extension	ralonge de barre	Estensione della barra	Cañin / Alargadera/ Stick	Pinnenausleger	Estenção de cana de leme ou cruzeta
2016	Timber	pièce de bois	Legname	Cuaderna / Madero	Holz	?
2017	Tip	pointe, extrémité	Punta, estremità	Extremo	Ende, Spitze	?

	English	Français	Italiano	Español	Deutsch	Português
2018	Tolerance	tolerance	Tolleranza	Tolerancia	Toleranz	Tolerância
2019	Top	plafond,	Sommità	Tapa	oben	Topo
2020	Torque	torque (rotation)	Coppia, momento torcente	Torsion	Drehung, Rotation	Torção
2021	Tow-rope (towline US)	corde de remorquage	Cima di rimorchio	Cabo de remolque	Schleppleine	Cabo de reboque
2022	Track	rail (d'écoute, etc)	Binario	Rail	Schiene	Calha
2023	Trailer	remorque	Rimorchio	Remolque	Anhaenger	Reboque
2024	Trailing edge	bord de fuite	Bordo di attacco	Borde de ataque	Hinterkante	Bordo de ataque
2025	Trampoline	trampoline	Trampoline	Trampolin	Trampolin	Trampolim
2026	Transom	tableau arrière	Specchio di poppa	Espejo de popa	Spiegel	Espelho de popa
2027	Trapeze	trapèze	Trapezio	Trapecio	Trapez	Trapézio
2028	Traveller (or car)	coulisseau	Carrello	Traveller / Carrilera	Traveller, Grossschotwagen	Carrinho
2029	Trim	assiette, réglage	Assetto, orientamento di vele	Reglaje / trimado	Trimm	Ajuste
2030	Trimaran	trimaran	Trimarano	Trimaran	Trimaran	Trimaran
2031	Trysail	voile tempête (triangulaire)	Vela da tempesta	Mayor de capa	Treisegel, Sturmsegel	Vela de capa
2032	Tumblehome	frégatage	Rientrata, restringimento delle murate	bocas		
2033	Tune	accordage	Messa a punto	Poner a punto		
2034	Turnbuckle	ridoir	Tornichetto	tensor	Vorreiber	
2035	Turn of the bilge	retour de galbord (?)		Curva de pantoque	Kimmsrundung	
2101	Under	sous, inférieur	Sotto	debajo	Unter	Debaixo
2102	Uphaul	hale-haut	Carica alto	varar	aufgeien	Levanter
2103	Upper	sur, supérieur	Superiore	superior	ober	Superior
2201	Vang	palan de retenue, hale-bas	Carica basso	Trapa	Niederholer	
2202	Varnish	vernis, peinture	Vernice	Varniz	Lack, Anstrich	
2301	Warp	chaîne (tissage)	Catena	Urdimbre / Estambre	Kette	
2302	Warping drum	guindeau		molinete		
2303	Waterline	ligne de flottaison	Linea di galleggiamento	Linea de Flotacion	Wasserlinie	Linha de água
2304	Waterplane	plan de flottaison	Piano di galleggiamento	Plano de Flotacion	Schwimmbene	Plano de flutuação
2305	Watertight	étanche	A tenuta d'acqua	estanco	Wasserdicht	
2306	Weft	trame (tissage)	Trama	Longitud / Paño de Vela	Schuss	
2307	Wet clothing	poids de l'équipement, détrempé	Abbigliamento umido	Traje humedo	Nasse Kleidung	Roupa molhada
2308	Wet suit	combinaison étanche	Muta	Neopreno	Neoprene	Neoprene
2309	Wheel	roue	Ruota	Rueda	Rad	Roda
2310	Whisker pole	whisker	Tangone	Tangon de campana		
2311	Winch	winch	Verricello	Chigre / Winch	Winch	
2312	Windlass	guindeau	Mulinello, ghinda	molinete	Ankerwinde	

	English	Français	Italiano	Español	Deutsch	Português
2313	Window	panneau transparent, fenêtre	finestra	Ventana	Fenster	Janela
2314	Wings	ailes	Ali	Ala	Fluegel	Asa
2315	Wingsail	voile profilée	Vela con profilo alare	Vela con Perfil alado	Profilsegel	Vela com perfil de asa
2316	Wire rope	câble	Cavo	Cable	Draht	Cabo de aço
2317	Wire splice	épissure de cable	Impiombatura	Empalme de Cables	Drahtspleiss	
2318	Wishbone	double corne (bôme)	Picco doppio	Botavara de Windsurf, Aparejo wishbone	Gabelbaum	Retranca de windsurf
2319	Wooven	tissé	Tessuto	Tejido	gewebt	tecido
2501	Yankee	grand foc	Yankee	Yankee		
2502	Yarn	fil, filin	Filaccia	Hilo	Garn	
2503	Yaw	balancement lateral horizontal	Bilanciamento laterale orizzontale	Guiñada	Gieren	Guinada
2504	Yawing moment	Moment de rotation horizontal	Momento di rotazione orizzontale	Momento de rotacion horizontal	Giermoment	Momento de rotação horizontal
2505	Yawl	yawl	Iola	Yola	Yawl	
2601	Zipper	fermeture éclair	Cremagliera	Cremallera	Reissverschluss	

Z.2 CONVERSION FACTORS

To convert		Multiply by
From	to	
mm	Inches	0.03937
inches	mm	25.4
m	feet	3.2808
fathom	m	1.83
m ²	sq. feet	10.764
sq. feet	m	0.0929
mm ²	cm ²	0.01
cm ²	mm ²	100
mm ²	sq. inches	0.00155
sq. inches	mm ²	645.16
litres	gallons (imp)	0.2200
litres	gallons (US)	0.2642
gallons (imp)	litres	4.546
gallons (US)	litres	3.785
m ³	litres	1000
kg (mass)	lb	2.204
kg	g	1000
t (mass)	kg (mass)	1000
N (Newton)	kgf	~0.1
kN	N	1000
MN	N	10 ⁶
N/mm ²	kgf/cm ²	~10
oz/sq. foot	g/m ²	305.24
oz/sq. yard	g/m ²	33.916
gr/m ²	oz/sq. foot	0.00328

Z.3 Mass Density of Some Substances (t/m³)

Plastic foams	0.01 – 0.04
Balsa wood	0.01 - 0.02
Spruce	0.40 – 0.43
Pine	0.45 – 0.65
Mahogany	0.55 – 0.85
Oak	0.68 – 0.95
Teak	0.88 – 0.95
Water at 4° C (in kg / m ³ or g / cm ³)	1.0
Salt water	1.02 – 1.03
Polyurethane	1.11 – 1.28
Cotton	1.54
Polyester fibres	1.4 – 1.72
Glass fibres	2.3 – 2.5
Aluminium	2.7
Antimonium	6.6
Titanium	4.5
Iron	6.9 – 7.85
Zinc	7.1
Steel	7.85
Brass	8.7 – 8.9
Copper	8.3 – 8.9
Silver	10.5
Lead (pure, without antimonium)	11.34
Mercury	13.6
Gold	19.3
Platinum	21.1